



SURGERY
TRAUMATOLOGY



Traumatologie
Traumatology

Traumatologie
Traumatoloía
Traumatologia

Katalog
Catalogue
Catalogue
Catálogo
Catalogo

No. **114**

Kataloge
Catalogues

Catalogues
Catálogos
Cataloghi

Endoskopie
Endoscopy

Endoscopia
Endoscopia
Endoscopia



Geräte
Units
Appareils
Equipos
Apparecchi

ENDOSCOPY No. **205**



Sinuskopie
Sinuscopy
Sinuscopie
Sinuscopia
Sinuscopia

ENDOSCOPY No. **211**



Optiken
Scopes
Optiques
Ópticas
Ottiche

ENDOSCOPY No. **206**



Mini & Mikro System für MIC
Mini & micro system for MIS
Système mini & mikro pour MIC
Sistema mini y micro para MIC
Sistema mini e micro per MIC

ENDOSCOPY No. **213**



Laparoskopie
Laparoscopy
Laparoscopie
Laparoscopia
Laparoscopia

ENDOSCOPY No. **207**



System zur lumbalen Diskektomie
Lumbar discectomy system
Système pour la discectomie lombaire
Sistema para la discectomia lumbar
Sistema per la discectomia lombare

ENDOSCOPY No. **601**



Urologie
Urology
Urologie
Urología
Urologia

ENDOSCOPY No. **208**

Sterilisation
Sterilization

Stérilisation
Esterilización
Sterilizzazione



Gynäkologie
Gynaecology
Gynécologie
Ginecología
Ginecologia

ENDOSCOPY No. **209**



Steril Container - System I
Sterile container - system I
Contenaires pour stérilisation - système I
Contenedores para esterilización - sistema I
Container per sterilizzazione - sistema I

STERILIZATION No. **302**



Arthroskopie
Arthroscopy
Arthroscopie
Artroscopia
Artroscopia

ENDOSCOPY No. **210**



Steril Container - System II
Sterile container - system II
Contenaires pour stérilisation - système II
Contenedores para esterilización - sistema II
Container per sterilizzazione - sistema II

STERILIZATION No. **303**

Kataloge | Catalogues
 Catalogues | Catálogos
 Cataloghi

Chirurgie | Chirurgie
 Surgery | Cirugía
 Chirurgia



Hauptkatalog Chirurgie
Main catalogue surgery
 Catalogue général
Catálogo general
 Catalogo generale
SURGERY No. **111**



Aneurysmen Clips
Aneurysm clips
 Clips pour anévrismes
Clips para aneurismas
 Clips per aneurismi
SURGERY No. **134**



Plastische Chirurgie
Plastic surgery
 Chirurgie plastique
Cirugía plástica
 Chirurgia plastica
SURGERY No. **112**



HNO Hauptkatalog
ENT main catalogue
 ORL catalogue général
ORL catálogo general
 ORL catalogo generale
ENT No. **501**



Ophthalmologie
Ophthalmology
 Ophthalmologie
Oftalmología
 Oftalmologia
SURGERY No. **113**

Elektro Chirurgie | Eléctrochirurgie
 Electro surgery | Electro-Cirugía
 Elettrobisturi



Traumatologie
Traumatology
 Traumatologie
Traumatología
 Traumatologia
SURGERY No. **114**



Elektro Chirurgie
Electro surgery
 Eléctrochirurgie
Electro-Cirugía
 Elettrobisturi
ELECTRO SURGERY No. **212**



Gefäßschirurgie
Vascular surgery
 Chirurgie vasculaire
Cirugía vascular
 Chirurgia vascolare
SURGERY No. **115**

Dental | Dentaire
 Dental | Dentale



Retraktor Systeme
Retractor systems
 Systèmes des écarteurs
Sistema de retractores
 Sistemi di retrattori
SURGERY No. **133**

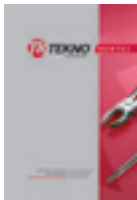

Dental
 Dental
 Dentaire
 Dental
 Dentale
DENTAL No. **402**

<p style="text-align: center;">Inhalt <i>Content</i></p>	<p style="text-align: center;">Contenu <i>Indice</i> Indice</p>
--	---

	<p>Markraumnägel – Küntscher Nägel – Markraumborher <i>Medullary nails – Küntscher nails – Medullary reamers</i> Clous médullaires – Clous Küntscher – Alésoirs médullaires <i>Clavos medulares – Clavos Küntscher – Trepanos medulares</i> Chiodi medulari – Chiodi Küntscher – Alessatori medulari</p>	<p>8 - 27</p>
	<p>Schenkelhalsnägel und –platten mit Instrumentarium <i>Femur nails and plates with instruments</i> Clous et plaques pour fémur, avec instruments <i>Clavos y placas para fémur, con instrumentos</i> Chiodi e placche per femro, con strumenti</p>	<p>28 - 31</p>
	<p>Knowles Nägel <i>Knowles pins</i> Clous Knowles <i>Clavos Knowles</i> Chiodi Knowles</p>	<p>32</p>
	<p>Dynamische Hüftschrauben/–platten, Dynamische Kondylenschrauben/–platten <i>Dynamic hip screws and plates, dynamic condylar screws and plates</i> Vis et plaques dynamiques pour hanche, vis et plaques pour condyles dynamiques <i>Tornillos y placas dinámicos para cadera, tornillos y placas dinámicos para condilos</i> Viti e placche dinamiche dell'anca, viti e placche dinamiche per condili</p>	<p>34 - 39</p>
	<p>Instrumentarium für dyn. Kondylenschrauben und –platten <i>Instruments for dynamic hip and condylar screws and plates</i> Instruments pour vis dynamiques et plaques pour condyles <i>Instrumentos para tornillos dinámicos y placas para condilos</i> Strumenti per viti e placche condiliche dinamiche</p>	<p>40 - 45</p>
	<p>Winkelplatten <i>Angular plates</i> Plaques angulaires <i>Placas anguladas</i> Placche angolate</p>	<p>46 - 55</p>
	<p>LARGE Fragment - Platten Schrauben, Instrumente <i>LARGE Fragment - Plates, screws, instruments</i> LARGE Fragment - Plaques, vis, instruments <i>LARGE Fragment - Placas, tornillos, instrumentos</i> LARGE Fragment - Placche, viti, strumenti</p>	<p>56 - 89</p>

Inhalt	Contenu
Content	Indice
	Indice



SMALL Fragment - Platten Schrauben, Instrumente
SMALL Fragment - Plates, screws, instruments
 SMALL Fragment - Plaques, vis, instruments
SMALL Fragment - Placas, tornillos, instrumentos
 SMALL Fragment - Placche, viti, strumenti

90 - 111

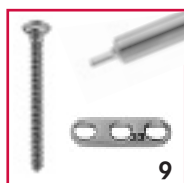

MINI Fragment - Platten Schrauben, Instrumente
MINI Fragment - Plates, screws, instruments
 MINI Fragment - Plaques, vis, instruments
MINI Fragment - Placas, tornillos, instrumentos
 MINI Fragment - Placche, viti, strumenti

112 - 125



Hohlschrauben für Osteosynthese
Cannulated screws for osteosynthesis
 Vis canulées pour ostéo-synthese
Tornillos huecos para osteosintesis
 Viti cannulati per ossa

126 - 138

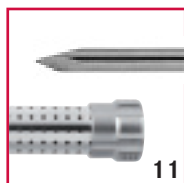

Kirschner Bohrdrähte - Steinmann Nägel - Schanz Schrauben
Kirschner wire drills - Steinmann pins - Schanz screws
 Broches Kirschner - Broches Steinmann - Vis de Schanz
Clavos Kirschner - Clavos Steinmann - Tornillos de Schanz
 Chiodi Kirschner - Chiodi Steinmann - Viti Schanz

139 - 141



Knochenklammern - Knochendraht - Drahtschneidezangen - Knochenhalte­zangen
Staples - Bone wire - Wire cutting forceps - Bone holding forceps
 Agrafes - Fils á os - Pince coupantes - Daviers port-os
Grapas - Alambres - Alicates corta-alambre - Pinzas porta huesos
 Agraffe - Filo per ossa - Pinze taglia filo - Tenaglie per ossa

142 - 170



Extensionsbügel - Container
Extension bows - Containers
 Etriers pour extension - Conteneires
Estribos para extensión - Contenedores
 Archi per estensione - Container

171 - 175

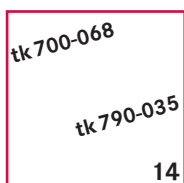

Nummernverzeichnis
Numerical index
 Index numérique
Indice numerico
 Indice dei numeri d'articolo

176 - 185

TITANK

Titan bildet an der Luft eine äußerst beständige oxidische Schutzschicht aus, die es in vielen Medien korrosionsbeständig macht. Bemerkenswert ist die hohe Festigkeit bei einer relativ geringen Dichte. Das Metall ist leicht, fest, dehnbar, korrosions- und temperaturbeständig. Es ist daher besonders für Anwendungen geeignet, bei denen es auf hohe Korrosionsbeständigkeit, Festigkeit und geringes Gewicht ankommt.

Titan wird verwendet:

- als Biomaterial für Implantate in der Medizintechnik und Zahnheilkunde wegen seiner sehr guten Korrosionsbeständigkeit im Gegensatz zu anderen Metallen. Eine immunologische Abstoßungsreaktion (Implantatallergie) gibt es nicht. Die Titan-Oxidschicht ermöglicht das feste Anwachsen von Knochen an das Implantat (Osseointegration) und ermöglicht damit den festen Einbau des künstlichen Implantates in den menschlichen Körper.
- in der Neurochirurgie haben Titan-Clips (für Aneurysma-Operationen) wegen ihrer günstigeren NMR-Eigenschaften solche aus Edelstahl weitgehend verdrängt. Biologische Nachteile des Titans im menschlichen Körper sind zur Zeit nicht bekannt. So lösten die bisher aus Titan hergestellten Knochenschrauben, Knochenplatten, Hüftgelenke oder Kieferimplantate keinerlei Allergien aus.

On open air Titanium forms on its surface a highly persistent oxidic protection layer, which turns it resistant against corrosion in many media. Titanium has a remarkable high strength at a relatively low density. The metal is light, strong, elastic and resistant against corrosion and temperature. It is therefore especially suitable for all applications where corrosion resistance, strength and low weight matter.

Titanium is used :

- *as bio-compatible material for implants in surgery and dental fields because of its high corrosion resistance compared to other metals. The use of Titanium implants does not lead to immunologic rejections (implant allergy). The oxidic layer enables the tight growth of bones to the implants (osseointegration) and thus a firm fitting of the artificial implant to the human body.*
- *for aneurysm clips in neurosurgery. Due to their positive NMR quality, Titanium clips have mostly replaced the stainless steel models.*

For the time being, now biological disadvantages of Titanium implants are known. Titanium made bone screws and plates, hip joints or jaw implants did up to now not cause any allergic reactions.

En réaction avec de l'air, le titane forme une couche oxydique de protection, que le rend résistante à la corrosion dans beaucoup des milieux. Titane a une remarquablement haute fermeté à une relativement basse densité. Le métal est léger, solide, élastique et résistant contre corrosion et température. Il est spécialement doué pour des applications que demandent la résistance contre corrosion, solidité et peu de poids.

Le titane est utilisé :

- comme matériel bio-compatible pour des implants en chirurgie classique et dentaire à cause de sa haute résistance à la corrosion, comparé avec des autres métaux. L'utilisation du titane ne provoque pas des rejets immunologiques (allergie contre implants). La couche oxydique permet l'implantation parfaite des os aux implants (intégration osseuse) et par ceci l'intégration idéale de l'implant artificiel dans le corps humain.
- en neurochirurgie pour des clips pour anévrysmes. A cause de leurs qualités positives NMR, ils ont presque complètement remplacés des clips en acier inoxydable.

Actuellement, aucunes désavantages biologiques des implants en titane sont connues. Jusqu'au présent des vis et plaques pour os, des implants de hanche et dentaires en titane n'ont pas provoqués des allergies.



TITANK

En una reacción con el aire, el titanio forma una capa de protección oxidica durable que le hace resistente a la corrosión en muchos medios. Titanio tiene una solidez remarcablemente alta junto con una densidad relativamente baja. El metal está ligero, sólido, elastico y resistente a la corrosión y temperatura. El titanio está especialmente apto para aplicaciones que exigen una resistencia a la corrosión, solidez y poco peso.

El titanio está utilizado:

- *como material bio compatible para implantes en la cirugía classica y dental por su alta resistencia a la corrosión, comparado con otros metales. La utilización del titanio no provoca rechazos inmunologicas (alergias a implantes). La capa oxidica permite el crecimiento fijo de los huesos a los implantes (integración osseo) y por esto la integración perfecta de un implante artificial en el cuerpo humano.*
- *en la neurocirugía para los clips de aneurisma. Por sus calidades positivas de NMR, han casi completamente remplacados los clips en acero inoxidable.*

Actualmente ningunas desventajas biologicas de implantes en titanio so conocidas. Hasta ahora, los tornillos, placas, implanteds de cadera o dentales producidos en titanio no han provocados alergias.

All'aria aperta il titanio forma sulla sua superficie uno strato altamente protettivo di ossido che lo rende resistente alla corrosione in molti ambienti. Il titanio ha una resistenza notevolmente alta con una densità relativamente bassa. Il metallo è leggero, forte, elastico e resistente alla corrosione e alla temperatura. E 'quindi particolarmente adatto per tutte le applicazioni dove resistenza alla corrosione, robustezza e leggerezza sono importanti

Il titanio è utilizzato:

- *come materiale bio-compatibile per gli impianti in campo dentale e chirurgia grazie alla sua elevata resistenza alla corrosione rispetto ad altri metalli. L'utilizzo degli impianti in titanio non causa reazioni immunitarie (allergia all'impianto). Lo strato di ossido permette la crescita delle ossa direttamente sull'impianto (osseo-integrazione) e quindi una decisa fissazione dell'impianto stesso al corpo umano.*
- *per clip da aneurisma in neurochirurgia. Grazie alla loro caratteristica di essere NMR positive, le clip in titanio hanno per lo più sostituito i modelli in acciaio inossidabile.*

Per il momento, gli svantaggi biologici di impianti in titanio sono noti. Fino ad ora viti, placche ossee, articolazioni dell'anca o impianti dentali in titanio ha non hanno causato reazioni allergiche.



Set für flexible Markraumnägel
Set for flexible medullary nails

Jeu des clous médullaires flexibles
Juego de clavos medulares flexibles
Set di chiodi flessibili medulari

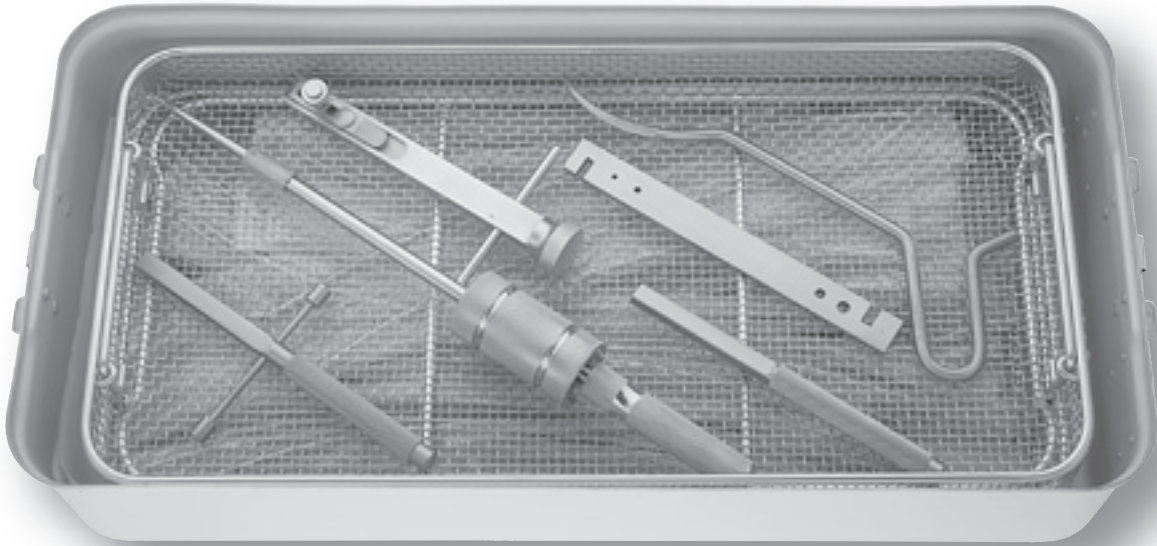

tk38442-10

Dieser Satz beinhaltet Instrumente der Pos. 01-09, siehe Seite 9

This set contents the instruments acc. to pos. 01-09, see page 9

Ce jeu contient instruments des positions 01-09, voir page 9

Este juego contiene los instrumentos de las posiciones 01-09, veasé pagina 9

Questo set contiene gli strumenti delle pos. 01-09, vedi pagina 9

Set für flexible Markraumnägel
Set for flexible medullary nails

Jeu des clous médullaires flexibles
Juego de clavos medulares flexibles
Set di chiodi flessibili medulari

[pos 01]	<i>Container</i>	580 x 280 x 135 mm	tk 87180-1F-SI	1 x	→ 0 173
[pos 02]	<i>Tray</i>	540 x 250 x 50 mm	tk 87015-02	2 x	→ 0 173
[pos 03]	<i>Flexible medullary nails, 4.5 mm Ø</i>	300 mm - 490 mm	tk 36078-30 - 36078-49	3 x of each (total 60 pcs.)	→ 0 10
[pos 04]	<i>Nail inserter</i>	150 mm	tk 36080-15	1 x	→ 0 11
[pos 05]	<i>Impactor</i>	220 mm	tk 36081-22	1 x	→ 0 11
[pos 06]	<i>Bender</i>	210 mm	tk 36082-21	1 x	→ 0 11
[pos 07]	<i>Impactor - Extractor</i>	200 mm	tk 36083-20	1 x	→ 0 12
[pos 08]	<i>Extractor</i>	400 mm	tk 36084-40	1 x	→ 0 12
KÜNTSCHER [pos 09]	<i>Awl</i>	260 mm	tk 38112-08	1 x	→ 0 11

Flexible Markraumnägel
Flexible medullary nails

Clous médullaires flexibles
Clavos medulares flexibles
Chiodi flessibili medulari



x =	4.5 mm Ø
300 mm - 12 "	tk 36078-30
310 mm - 12¼ "	tk 36078-31
320 mm - 12½ "	tk 36078-32
330 mm - 13 "	tk 36078-33
340 mm - 13½ "	tk 36078-34
350 mm - 13¾ "	tk 36078-35
360 mm - 14¼ "	tk 36078-36
370 mm - 14½ "	tk 36078-37
380 mm - 15 "	tk 36078-38
390 mm - 15½ "	tk 36078-39
400 mm - 15¾ "	tk 36078-40
410 mm - 16¼ "	tk 36078-41
420 mm - 16½ "	tk 36078-42
430 mm - 17 "	tk 36078-43
440 mm - 17¼ "	tk 36078-44
450 mm - 17¾ "	tk 36078-45
460 mm - 18 "	tk 36078-46
470 mm - 18½ "	tk 36078-47
480 mm - 18¾ "	tk 36078-48
490 mm - 19¼ "	tk 36078-49

Instrumentarium für flexible Markraumnägel
Instruments for flexible medullary nails

Instruments pour clous médullaires flexibles
Instrumental para clavos medulares flexibles
 Strumentario per chiodi flessibili medulari



KÜNTSCHER

	260 mm - 10¼"
8.0 mm Ø	tk 38112-08

Pfriem
Awl
 Alêne
Lezna
 punteruolo



150 mm - 6"

tk 36080-15

Einschläger
Nail inserter
 Impacteur
Impactor
 Impattatore



220 mm - 8¾"

tk 36081-22

Nachschlaginstrument
Impactor
 Impacteur
Impactor
 Impattatore



210 mm - 8¼"

tk 36082-21

Biegehebel
Bender
 Levier pour plier
Palanca para plegar clavos
 Leva per piegare chiodi

Instrumentarium für flexible Markraumnägel
Instruments for flexible medullary nails

Instruments pour clous médullaires flexibles
Instrumental para clavos medulares flexibles
Strumentario per chiodi flessibili medulari



200 mm - 8"

tk 36083-20

Nachschlaginstrument, Extraktor

Impactor, extractor

Impacteur, extracteur

Impactor, extractor

Impattatore / estrattore



400 mm - 16"

tk 36084-40

Extraktionshaken

Extractor

Extracteur

Extractor

Estrattore



STERILIZATION

Sterilisations Container | Contenaires pour stérilisation
Sterilization containers | Contenedores para esterilización
Container per sterilizzazione



Bitte fordern Sie unseren Spezialkatalog an.
Please ask for our special catalogue.

*Veillez demander pour notre catalogue spécial.
Por favor preguntan para el catálogo especial.*

Per favore domandate per il nostro catalogo speciale.

Instrumenten-Set für Küntscher-Nägel
Küntscher nails instrument set

Jeu d'instruments pour des clous Küntscher
Juego de instrumentos para los clavos Küntscher
Set di strumenti per chiodi Küntscher



tk 38442-20

Dieser Satz beinhaltet Instrumente der Pos. 01-13, siehe Seite 15

This set contents the instruments acc. to pos. 01-13, see page 15

Ce jeu contient instruments des positions 01-13, voir page 15

Este juego contiene los instrumentos de las posiciones 01-13, veasé pagina 15

Questo set contiene gli strumenti delle pos. 01-13, vedi pagina 15

Instrumenten-Set für Küntscher-Nägel
Küntscher nails instrument set

 Jeu d'instruments pour des clous Küntscher
 Juego de instrumentos para los clavos Küntscher
 Set di strumenti per chiodi Küntscher

[pos 01]	<i>Container</i>	580 x 280 x 100 mm	tk 87170-1F-SI	1 x	→ 0 173
[pos 02]	<i>Wire mesh basket</i>	540 x 250 x 50 mm	tk 87015-02	1 x	→ 0 173
KÜNTSCHER [pos 03]	<i>Awl</i>	260 mm	tk 38112-10	1 x	→ 0 19
KÜNTSCHER [pos 04]	<i>Reamer</i>	350 mm	tk 38110-35	1 x	→ 0 19
[pos 05]	<i>Mallet, slotted</i>	270 mm	tk 38318-10	1 x	→ 0 53
[pos 06]	<i>Nail driver, slotted</i>		tk 38120-21	1 x	→ 0 20
[pos 07]	<i>Nail impactor, 6.0 mm - 8.0 mm Ø</i>		tk 38122-06	1 x	→ 0 20
[pos 09]	<i>Nail impactor, 9.0 mm - 12.0 mm Ø</i>		tk 38122-09	1 x	→ 0 20
[pos 10]	<i>Nail impactor, 13.0 mm - 20.0 mm Ø</i>		tk 38122-13	1 x	→ 0 20
KÜNTSCHER [pos 11]	<i>Extractor</i>	370 mm	tk 38118-00	1 x	→ 0 21
[pos 12]	<i>Measuring gauge for Küntscher nails</i>		tk 38229-00	1 x	→ 0 17
[pos 13]	<i>Mallet, 450 g</i>	265 mm	tk 24054-01	1 x	→ 0 20

Küntscher-Nägel für Oberschenkel
Küntscher intramedullary femur nails

 Clous de Küntscher pour fémurs
 Clavos de Küntscher para femures
 Chiodi di Küntscher per femore

STAINLESS STEEL

KÜNTSCHER

	6.0 mm Ø	7.0 mm Ø	8.0 mm Ø	9.0 mm Ø	10.0 mm Ø
140 mm - 5½"	tk 38200-14	tk 38201-14			
160 mm - 6¼"	tk 38200-16	tk 38201-16			
180 mm - 7"	tk 38200-18	tk 38201-18			
200 mm - 8"	tk 38200-20	tk 38201-20			
220 mm - 8¾"	tk 38200-22	tk 38201-22			
240 mm - 9½"	tk 38200-24	tk 38201-24	tk 38202-24		
260 mm - 10¼"	tk 38200-26	tk 38201-26	tk 38202-26		
280 mm - 11"	tk 38200-28	tk 38201-28	tk 38202-28		
300 mm - 12"	tk 38200-30	tk 38201-30	tk 38202-30	tk 38203-30	
320 mm - 12½"	tk 38200-32	tk 38201-32	tk 38202-32	tk 38203-32	tk 38204-32
340 mm - 13½"	tk 38200-34	tk 38201-34	tk 38202-34	tk 38203-34	tk 38204-34
360 mm - 14¼"	tk 38200-36	tk 38201-36	tk 38202-36	tk 38203-36	tk 38204-36
380 mm - 15"		tk 38201-38	tk 38202-38	tk 38203-38	tk 38204-38
400 mm - 15¾"		tk 38201-40	tk 38202-40	tk 38203-40	tk 38204-40
420 mm - 16½"			tk 38202-42	tk 38203-42	tk 38204-42
440 mm - 17¼"			tk 38202-44	tk 38203-44	tk 38204-44
460 mm - 18"			tk 38202-46	tk 38203-46	tk 38204-46
480 mm - 18¾"			tk 38202-48	tk 38203-48	tk 38204-48
500 mm - 19¾"			tk 38202-50	tk 38203-50	tk 38204-50
520 mm - 20½"			tk 38202-52	tk 38203-52	tk 38204-52

	11.0 mm Ø	12.0 mm Ø	13.0 mm Ø	14.0 mm Ø	15.0 mm Ø
320 mm - 12½"	tk 38205-32				
340 mm - 13½"	tk 38205-34	tk 38206-34	tk 38207-34	tk 38208-34	
360 mm - 14¼"	tk 38205-36	tk 38206-36	tk 38207-36	tk 38208-36	tk 38209-36
380 mm - 15"	tk 38205-38	tk 38206-38	tk 38207-38	tk 38208-38	tk 38209-38
400 mm - 15¾"	tk 38205-40	tk 38206-40	tk 38207-40	tk 38208-40	tk 38209-40
420 mm - 16½"	tk 38205-42	tk 38206-42	tk 38207-42	tk 38208-42	tk 38209-42
440 mm - 17¼"	tk 38205-44	tk 38206-44	tk 38207-44	tk 38208-44	tk 38209-44
460 mm - 18"	tk 38205-46	tk 38206-46	tk 38207-46	tk 38208-46	tk 38209-46
480 mm - 18¾"	tk 38205-48	tk 38206-48	tk 38207-48	tk 38208-48	tk 38209-48
500 mm - 19¾"	tk 38205-50	tk 38206-50	tk 38207-50	tk 38208-50	tk 38209-50
520 mm - 20½"	tk 38205-52	tk 38206-52	tk 38207-52	tk 38208-52	tk 38209-52

Küntscher-Nägel für Oberschenkel
Küntscher intramedullary femur nails

Clous de Küntscher pour fémurs
 Clavos de Küntscher para femures
 Chiodi di Küntscher per femore

STAINLESS STEEL

KÜNTSCHER

	6.0 mm Ø	7.0 mm Ø	8.0 mm Ø	9.0 mm Ø	10.0 mm Ø
140 mm - 5½"	tk 382 10-14	tk 382 11-14			
160 mm - 6¼"	tk 382 10-16	tk 382 11-16			
180 mm - 7"	tk 382 10-18	tk 382 11-18			
200 mm - 8"	tk 382 10-20	tk 382 11-20			
220 mm - 8¾"	tk 382 10-22	tk 382 11-22			
240 mm - 10¼"	tk 382 10-24	tk 382 11-24	tk 382 12-24		
260 mm - 10½"	tk 382 10-26	tk 382 11-26	tk 382 12-26		
280 mm - 11"	tk 382 10-28	tk 382 11-28	tk 382 12-28		
300 mm - 12"	tk 382 10-30	tk 382 11-30	tk 382 12-30	tk 382 13-30	
320 mm - 12½"	tk 382 10-32	tk 382 11-32	tk 382 12-32	tk 382 13-32	tk 382 14-32
340 mm - 13½"	tk 382 10-34	tk 382 11-34	tk 382 12-34	tk 382 13-34	tk 382 14-34
360 mm - 14"	tk 382 10-36	tk 382 11-36	tk 382 12-36	tk 382 13-36	tk 382 14-36
380 mm - 15"		tk 382 11-38	tk 382 12-38	tk 382 13-38	tk 382 14-38
400 mm - 15¾"		tk 382 11-40	tk 382 12-40	tk 382 13-40	tk 382 14-40
420 mm - 16½"			tk 382 12-42	tk 382 13-42	tk 382 14-42
440 mm - 17¼"			tk 382 12-44	tk 382 13-44	tk 382 14-44
460 mm - 18"			tk 382 12-46	tk 382 13-46	tk 382 14-46
480 mm - 19¼"			tk 382 12-48	tk 382 13-48	tk 382 14-48
500 mm - 20"			tk 382 12-50	tk 382 13-50	tk 382 14-50
520 mm - 20½"			tk 382 12-52	tk 382 13-52	tk 382 14-52

	11.0 mm Ø	12.0 mm Ø	13.0 mm Ø	14.0 mm Ø	15.0 mm Ø
320 mm - 12½"	tk 382 15-32				
340 mm - 13½"	tk 382 15-34	tk 382 16-34	tk 382 17-34	tk 382 18-34	
360 mm - 14"	tk 382 15-36	tk 382 16-36	tk 382 17-36	tk 382 18-36	tk 382 19-36
380 mm - 15"	tk 382 15-38	tk 382 16-38	tk 382 17-38	tk 382 18-38	tk 382 19-38
400 mm - 15¾"	tk 382 15-40	tk 382 16-40	tk 382 17-40	tk 382 18-40	tk 382 19-40
420 mm - 16½"	tk 382 15-42	tk 382 16-42	tk 382 17-42	tk 382 18-42	tk 382 19-42
440 mm - 17¼"	tk 382 15-44	tk 382 16-44	tk 382 17-44	tk 382 18-44	tk 382 19-44
460 mm - 18"	tk 382 15-46	tk 382 16-46	tk 382 17-46	tk 382 18-46	tk 382 19-46
480 mm - 19¼"	tk 382 15-48	tk 382 16-48	tk 382 17-48	tk 382 18-48	tk 382 19-48
500 mm - 20"	tk 382 15-50	tk 382 16-50	tk 382 17-50	tk 382 18-50	tk 382 19-50
520 mm - 20½"	tk 382 15-52	tk 382 16-52	tk 382 17-52	tk 382 18-52	tk 382 19-52



tk 38229-00

Meßlehre für Küntschernägel
Measuring gauge für Küntscher nails

Calibre pour des clous Küntscher
Calibre para clavos de Küntscher
 Calibro per chiodi di Küntscher

Küntscher-Nägel für Unterschenkel und Oberarm
Küntscher intramedullary, tibia and humerus nails

Clous de Küntscher pour humérus et jambes
Clavos de Küntscher para húmeros y piernas
 Chiodi Küntscher per tibia e humerus

STAINLESS STEEL

KÜNTSCHER

	6.0 mm Ø	7.0 mm Ø	8.0 mm Ø	9.0 mm Ø	10.0 mm Ø
180 mm - 7"	tk 38220-18	tk 38221-18	tk 38222-18	tk 38223-18	tk 38224-18
190 mm - 7¼"	tk 38220-19	tk 38221-19	tk 38222-19	tk 38223-19	tk 38224-19
200 mm - 8"	tk 38220-20	tk 38221-20	tk 38222-20	tk 38223-20	tk 38224-20
210 mm - 8¼"	tk 38220-21	tk 38221-21	tk 38222-21	tk 38223-21	tk 38224-21
220 mm - 8¾"	tk 38220-22	tk 38221-22	tk 38222-22	tk 38223-22	tk 38224-22
230 mm - 9"	tk 38220-23	tk 38221-23	tk 38222-23	tk 38223-23	tk 38224-23
240 mm - 9½"	tk 38220-24	tk 38221-24	tk 38222-24	tk 38223-24	tk 38224-24
250 mm - 10"	tk 38220-25	tk 38221-25	tk 38222-25	tk 38223-25	tk 38224-25
260 mm - 10¼"	tk 38220-26	tk 38221-26	tk 38222-26	tk 38223-26	tk 38224-26
270 mm - 10¾"	tk 38220-27	tk 38221-27	tk 38222-27	tk 38223-27	tk 38224-27
280 mm - 11"	tk 38220-28	tk 38221-28	tk 38222-28	tk 38223-28	tk 38224-28
290 mm - 11½"	tk 38220-29	tk 38221-29	tk 38222-29	tk 38223-29	tk 38224-29
300 mm - 12"	tk 38220-30	tk 38221-30	tk 38222-30	tk 38223-30	tk 38224-30
310 mm - 12¼"		tk 38221-31	tk 38222-31	tk 38223-31	tk 38224-31
320 mm - 12½"		tk 38221-32	tk 38222-32	tk 38223-32	tk 38224-32
330 mm - 13"		tk 38221-33	tk 38222-33	tk 38223-33	tk 38224-33
340 mm - 13½"		tk 38221-34	tk 38222-34	tk 38223-34	tk 38224-34
350 mm - 13¾"		tk 38221-35	tk 38222-35	tk 38223-35	tk 38224-35
360 mm - 14"		tk 38221-36	tk 38222-36	tk 38223-36	tk 38224-36
370 mm - 14½"		tk 38221-37	tk 38222-37	tk 38223-37	tk 38224-37
380 mm - 15"		tk 38221-38	tk 38222-38	tk 38223-38	tk 38224-38
390 mm - 15½"		tk 38221-39	tk 38222-39	tk 38223-39	tk 38224-39
400 mm - 15¾"		tk 38221-40	tk 38222-40	tk 38223-40	tk 38224-40

	11.0 mm Ø	12.0 mm Ø	13.0 mm Ø	14.0 mm Ø
180 mm - 7"	tk 38225-18	tk 38226-18	tk 38227-18	
190 mm - 7¼"	tk 38225-19	tk 38226-19	tk 38227-19	
200 mm - 8"	tk 38225-20	tk 38226-20	tk 38227-20	
210 mm - 8¼"	tk 38225-21	tk 38226-21	tk 38227-21	
220 mm - 8¾"	tk 38225-22	tk 38226-22	tk 38227-22	
230 mm - 9"	tk 38225-23	tk 38226-23	tk 38227-23	
240 mm - 9½"	tk 38225-24	tk 38226-24	tk 38227-24	
250 mm - 10"	tk 38225-25	tk 38226-25	tk 38227-25	
260 mm - 10¼"	tk 38225-26	tk 38226-26	tk 38227-26	
270 mm - 10¾"	tk 38225-27	tk 38226-27	tk 38227-27	
280 mm - 11"	tk 38225-28	tk 38226-28	tk 38227-28	
290 mm - 11½"	tk 38225-29	tk 38226-29	tk 38227-29	
300 mm - 12"	tk 38225-30	tk 38226-30	tk 38227-30	tk 38228-30
310 mm - 12¼"	tk 38225-31	tk 38226-31	tk 38227-31	tk 38228-31
320 mm - 12½"	tk 38225-32	tk 38226-32	tk 38227-32	tk 38228-32
330 mm - 13"	tk 38225-33	tk 38226-33	tk 38227-33	tk 38228-33
340 mm - 13½"	tk 38225-34	tk 38226-34	tk 38227-34	tk 38228-34
350 mm - 13¾"	tk 38225-35	tk 38226-35	tk 38227-35	tk 38228-35
360 mm - 14"	tk 38225-36	tk 38226-36	tk 38227-36	tk 38228-36
370 mm - 14½"	tk 38225-37	tk 38226-37	tk 38227-37	tk 38228-37
380 mm - 15"	tk 38225-38	tk 38226-38	tk 38227-38	tk 38228-38
390 mm - 15½"	tk 38225-39	tk 38226-39	tk 38227-39	tk 38228-39
400 mm - 15¾"	tk 38225-40	tk 38226-40	tk 38227-40	tk 38228-40



Instrumentarium für Küntscher-Nägel
Instruments for Küntscher nails

Instruments pour clous de Küntscher
Instrumental para clavos de Küntscher
 Strumentario per chiodi di Küntscher



KÜNTSCHER

350 mm - 13¾"

tk 38 110-35

Vorbohrer

Reamer

Mèche

Trepano

Perforatore



KÜNTSCHER

260 mm - 10¼"

8.0 mm Ø

tk 38 112-08

10.0 mm Ø

tk 38 112-10

Pfriem

Awl

Alêne

Lezna

Perforatore



600 mm - 23½"

3.0 mm Ø

tk 38 114-30

3.5 mm Ø

tk 38 114-35

4.0 mm Ø

tk 38 114-40

5.0 mm Ø

tk 38 114-50

Führungsspieß

Guide pin

Broche de guidage

Broca de guía

Filo guida

Instrumentarium für Küntscher-Nägel
Instruments for Küntscher nails

Instruments pour clous de Küntscher
Instrumental para clavos de Küntscher
Strumentario per chiodi di Küntscher



KÜNTSCHER
tk 38120-21

Vorschläger mit Schlitz
Slotted nail driver
Marteau fenté
Martillo hendido
Martello con fessura



KÜNTSCHER

6.0 mm - 8.0 mm Ø	tk 38122-06
9.0 mm - 12.0 mm Ø	tk 38122-09
13.0 mm - 20.0 mm Ø	tk 38122-13

Für Nägel <i>For nails</i>	Fertigschläger <i>Nail impactor</i>
Pour clous <i>Para clavos</i>	Impacteur <i>Impactor</i>
Per chiodi	Impattatore finale



1:2

	30 mm Ø - 450 g	50 mm Ø - 900 g
265 mm - 10½"	tk 24054-01	tk 24054-02

Stahl massiv
Steel solid
Acier solide
Acero sólido
Acciaio massiccio

Instrumentarium für Küntscher-Nägel
Instruments for Küntscher nails

Instruments pour clous de Küntscher
Instrumental para clavos de Küntscher
Strumentario per chiodi di Küntscher



KÜNTSCHER

tk 38118-00

Extraktor mit zwei Haken
Nail extractor with two hooks
Extracteur avec deux crochets
Extractor con dos ganchos
Estrattore con due ganci



tk 38125-30

Schlitzhammer
Slotted mallet
Marteau fenté
Martillo hendido
Martello con fessura per estrazione



	290 mm - 11½"	370 mm - 14½"	430 mm - 17"	510 mm - 20"
Ø 5.0 mm	tk 38114-30	tk 38114-35	tk 38114-40	tk 38114-50

Extraktionshaken
Extraction hooks
Crochet d'extraction
Gancho de extracción
Uncino d'estrazione

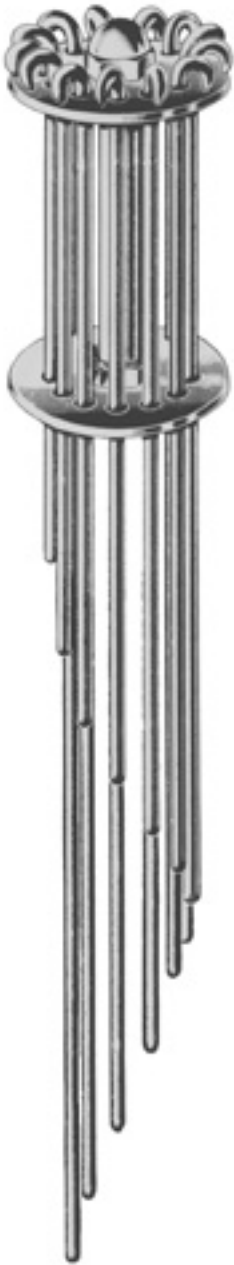
**Markraumnägel
Medullary nails**
**Clous médullaires
Clavos medulares
Chiodi medulari**

RUSH

	2.4 mm Ø	3.2 mm Ø
25 mm - 1 "	tk 36250-25	-
30 mm - 1¼ "	tk 36250-30	-
40 mm - 1½ "	tk 36250-40	-
45 mm - 1¾ "	tk 36250-45	-
50 mm - 2 "	tk 36250-50	-
60 mm - 2¼ "	tk 36250-60	-
65 mm - 2½ "	tk 36250-65	-
70 mm - 2¾ "	tk 36250-70	-
75 mm - 3 "	tk 36250-75	-
85 mm - 3¼ "	tk 36250-85	-
90 mm - 3½ "	tk 36250-90	-
95 mm - 3¾ "	tk 36250-95	-
100 mm - 4 "	tk 36250-10	tk 36251-10
115 mm - 4½ "	tk 36250-11	tk 36251-11
125 mm - 5 "	tk 36250-12	tk 36251-12
140 mm - 5½ "	tk 36250-14	tk 36251-14
150 mm - 6 "	tk 36250-15	tk 36251-15
165 mm - 6½ "	tk 36250-16	tk 36251-16
180 mm - 7 "	tk 36250-18	tk 36251-18
190 mm - 7½ "	tk 36250-19	tk 36251-19
205 mm - 8 "	tk 36250-20	tk 36251-20
215 mm - 8½ "	tk 36250-21	tk 36251-21
230 mm - 9 "	tk 36250-23	-
235 mm - 9¼ "	-	tk 36251-23
240 mm - 9½ "	tk 36250-24	tk 36251-24
255 mm - 10 "	tk 36250-26	tk 36251-25
<hr/>		
25 - 100 mm	tk 36250-00	-

Satz mit 13 Nägeln 25-100 mm und Halter
Set of 13 pins 25-100 mm and rack

Jeu de 13 clous 25-100 mm et un support
Juego de 13 clavos de 25-100 mm y un soporte
Set di 13 chiodi 25-100 mm con supporto

100 - 255 mm	tk 36250-99	-
<hr/>		
100 - 255 mm	-	tk 36251-00

Satz mit 13 Nägeln 100-255 mm und Halter
Set of 13 pins 100-255 mm and rack

Jeu de 13 clous 100-255 mm et un support
Juego de 13 clavos de 100-255 mm y un soporte
Set di 13 chiodi 100-255 mm con supporto

100 - 255 mm	-	tk 36251-00
--------------	---	--------------------

Satz mit 13 Nägeln 100-255 mm und Halter
Set of 13 pins 100-255 mm and rack

Jeu de 13 clous 100-255 mm et un support
Juego de 13 clavos de 100-255 mm y un soporte
Set di 13 chiodi 100-255 mm con supporto

RUSH

	4.8 mm Ø
205 mm - 8 "	tk 36252-20
220 mm - 8¾ "	tk 36252-22
240 mm - 9½ "	tk 36252-24
255 mm - 10 "	tk 36252-25
280 mm - 11 "	tk 36252-28
295 mm - 11½ "	tk 36252-29
315 mm - 12½ "	tk 36252-31
335 mm - 13¼ "	tk 36252-33
<hr/>	
205 - 355 mm	tk 36252-00

Satz mit 9 Nägeln 205-355 mm und Halter
Set of 9 pins 205-355 mm and rack

Jeu de 9 clous 205-355 mm et un support
Juego de 9 clavos de 205-355 mm y un soporte
Set di 9 chiodi 205-355 mm con supporto

RUSH

	6.4 mm Ø
280 mm - 11 "	tk 36253-28
295 mm - 11½ "	tk 36253-29
315 mm - 12½ "	tk 36253-31
335 mm - 13¼ "	tk 36253-33
355 mm - 14 "	tk 36253-35
375 mm - 14¾ "	tk 36253-37
395 mm - 15½ "	tk 36253-39
410 mm - 16¼ "	tk 36253-41

Satz mit 9 Nägeln 280-430 mm und Halter
Set of 9 pins 280-430 mm and rack

Jeu de 9 clous 280-430 mm et un support
Juego de 9 clavos de 280-430 mm y un soporte
Set di 9 chiodi 280-430 mm con supporto

280 - 430 mm	tk 36253-00
--------------	--------------------

Instrumentarium für Markraumnägel
Instruments for medullary nails

Instruments pour clous médullaires
Instrumentos para clavos medulares
Strumentario per chiodi medulari



2.4 mm Ø	3.2 mm Ø	4.8 mm Ø	6.4 mm Ø
tk 36265-01	tk 36265-02	tk 36265-03	tk 36265-04

Vorbohrer
Reamer
Mèche
Trepano
Perforatore



2.4 mm Ø	3.2 mm Ø	4.8 mm Ø	6.4 mm Ø
tk 36260-01	tk 36260-02	tk 36260-03	tk 36260-04

Vorschläger, Extraktor
Driver, extractor
Impacteur, extracteur
Impactor, extractor
Impattore, estrattore



210 mm - 8¼"
tk 36082-21

Biegehebel
Bender
Lever pour plier
Palanca para plegar clavos
Leva per piegare chiodi

Markraumbohrer-Satz
Medullary canal reamers set

Jeu d'alésoirs flexibles
Juego de trepanos intramedulares flexibles
Set d'alessatori flessibili



tk37570-00

Dieser Satz beinhaltet Instrumente der Pos. 01-26, siehe Seite 25
This set contents the instruments acc. to pos. 01-26, see page 25

Ce jeu contient instruments des positions 01-26, voir page 25

Este juego contiene los instrumentos de las posiciones 01-26, veasé pagina 25

Questo set contiene gli strumenti delle pos. 01-26, vedi pagina 25

Markraumbohrer-Satz
Medullary canal reamers set

Jeu d'alésoirs flexibles
Juego de trepanos intramedulares flexibles
Set d'alessatori flessibili

[pos 01]	Container	580 x 280 x 135 mm	tk87180-1F-SI	1 x	→ 0 173
[pos 02]	Tray	530 x 245 x 95 mm	tk87050-50	2 x	
[pos 03]	Flexible medullary reamer, 470 mm	6.0 mm Ø	tk37570-60	1 x	→ 0 26
[pos 04]	Flexible medullary reamer, 470 mm	6.5 mm Ø	tk37570-65	1 x	→ 0 26
[pos 05]	Flexible medullary reamer, 470 mm	7.0 mm Ø	tk37570-70	1 x	→ 0 26
[pos 06]	Flexible medullary reamer, 470 mm	7.5 mm Ø	tk37570-75	1 x	→ 0 26
[pos 07]	Flexible medullary reamer, 470 mm	8.0 mm Ø	tk37570-80	1 x	→ 0 26
[pos 09]	Flexible medullary reamer, 470 mm	8.5 mm Ø	tk37570-85	1 x	→ 0 26
[pos 10]	Flexible medullary reamer, 470 mm	9.0 mm Ø	tk37570-90	1 x	→ 0 26
[pos 11]	Flexible medullary reamer, 470 mm	9.5 mm Ø	tk37570-95	1 x	→ 0 26
[pos 12]	Flexible medullary reamer, 470 mm	10.0 mm Ø	tk37571-00	1 x	→ 0 26
[pos 13]	Flexible medullary reamer, 470 mm	10.5 mm Ø	tk37571-05	1 x	→ 0 26
[pos 14]	Flexible medullary reamer, 470 mm	11.0 mm Ø	tk37571-10	1 x	→ 0 26
[pos 15]	Flexible medullary reamer, 470 mm	11.5 mm Ø	tk37571-15	1 x	→ 0 26
[pos 16]	Flexible medullary reamer, 470 mm	12.0 mm Ø	tk37571-20	1 x	→ 0 26
[pos 17]	Flexible medullary reamer, 470 mm	12.5 mm Ø	tk37571-25	1 x	→ 0 26
[pos 18]	Flexible medullary reamer, 470 mm	13.0 mm Ø	tk37571-30	1 x	→ 0 26
[pos 19]	Flexible medullary reamer, 470 mm	13.5 mm Ø	tk37571-35	1 x	→ 0 26
[pos 20]	Flexible medullary reamer, 470 mm	14.0 mm Ø	tk37571-40	1 x	→ 0 26
[pos 21]	Flexible medullary reamer, 470 mm	14.5 mm Ø	tk37571-45	1 x	→ 0 26
[pos 22]	Flexible medullary reamer, 470 mm	15.0 mm Ø	tk37571-50	1 x	→ 0 26
[pos 23]	Flexible medullary reamer, 470 mm	15.5 mm Ø	tk37571-55	1 x	→ 0 26
[pos 24]	Flexible medullary reamer, 470 mm	16.0 mm Ø	tk37571-60	1 x	→ 0 26
[pos 25]	Flexible medullary reamer, 470 mm	16.5 mm Ø	tk37571-65	1 x	→ 0 26
[pos 26]	Flexible medullary reamer, 470 mm	17.0 mm Ø	tk37571-70	1 x	→ 0 26

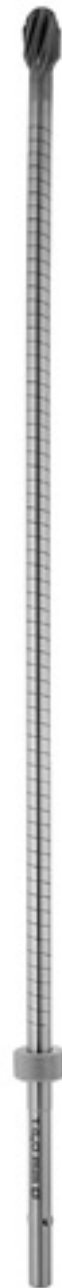
Markraumbohrer
Medullary canal reamers
Alesoirs médullaires
Trepanos intra medulares
Alessatori

	470 mm - 18½"	470 mm - 18½"
6.0 mm Ø	tk 37470-60	tk 37570-60
6.5 mm Ø	tk 37470-65	tk 37570-65
7.0 mm Ø	tk 37470-70	tk 37570-70
7.5 mm Ø	tk 37470-75	tk 37570-75
8.0 mm Ø	tk 37470-80	tk 37570-80
8.5 mm Ø	tk 37470-85	tk 37570-85
9.0 mm Ø	tk 37470-90	tk 37570-90
9.5 mm Ø	tk 37470-95	tk 37570-95
10.0 mm Ø	tk 37471-00	tk 37571-00
10.5 mm Ø	tk 37471-05	tk 37571-05
11.0 mm Ø	tk 37471-10	tk 37571-10
11.5 mm Ø	tk 37471-15	tk 37571-15
12.0 mm Ø	tk 37471-20	tk 37571-20
12.5 mm Ø	tk 37471-25	tk 37571-25
13.0 mm Ø	tk 37471-30	tk 37571-30
13.5 mm Ø	tk 37471-35	tk 37571-35
14.0 mm Ø	tk 37471-40	tk 37571-40
14.5 mm Ø	tk 37471-45	tk 37571-45
15.0 mm Ø	tk 37471-50	tk 37571-50
15.5 mm Ø	tk 37471-55	tk 37571-55
16.0 mm Ø	tk 37471-60	tk 37571-60
16.5 mm Ø	tk 37471-65	tk 37571-65
17.0 mm Ø	tk 37471-70	tk 37571-70
17.5 mm Ø	tk 37471-75	tk 37571-75
18.0 mm Ø	tk 37471-80	tk 37571-80

biegsam
malleable
 malléable
maleable
 malleabile

ohne Rändelschraube
without fixation screw
 sans vis de fixation
sin tornillo de fijación
 senza vite di fissaggio

mit Rändelschraube
with fixation screw
 avec vis de fixation
con tornillo de fijación
 con vite di fissaggio



Weitere Kupplungen auf Anfrage erhältlich
Further connections are available on request

Autres fixations sont disponibles sur demande
Otras fijaciones son disponibles según demanda
 Altri attacchi sono disponibile su richiesta

Markraumbohrer
Medullary canal reamers

Alesoirs médullaires
Trepanos intra medulares
Alessatori



	500 mm - 19¾"
6.0 mm Ø	tk 37580-06
7.0 mm Ø	tk 37580-07
8.0 mm Ø	tk 37580-08
9.0 mm Ø	tk 37580-09
10.0 mm Ø	tk 37580-10
11.0 mm Ø	tk 37580-11
12.0 mm Ø	tk 37580-12
13.0 mm Ø	tk 37580-13
14.0 mm Ø	tk 37580-14
15.0 mm Ø	tk 37580-15
16.0 mm Ø	tk 37580-16
17.0 mm Ø	tk 37580-17
18.0 mm Ø	tk 37580-18
19.0 mm Ø	tk 37580-19
20.0 mm Ø	tk 37580-20

Schenkelhalsnägeln
Femur nails

Clous pour fémurs
Clavos para femures
Chiodi per collo del femore

STAINLESS STEEL



SMITH-PETERSON

	12.7 mm Ø
60 mm - 2¼"	tk 38260-60
65 mm - 2½"	tk 38260-65
70 mm - 2¾"	tk 38260-70
75 mm - 3"	tk 38260-75
80 mm - 3¼"	tk 38260-80
85 mm - 3½"	tk 38260-85
90 mm - 3½"	tk 38260-90
95 mm - 3¾"	tk 38260-95
100 mm - 4"	tk 38261-00
105 mm - 4¼"	tk 38261-05
110 mm - 4¼"	tk 38261-10
115 mm - 4½"	tk 38261-15
120 mm - 4¾"	tk 38261-20
125 mm - 5"	tk 38261-25
130 mm - 5¼"	tk 38261-30
135 mm - 5¼"	tk 38261-35
140 mm - 5½"	tk 38261-40
145 mm - 5¾"	tk 38261-45
150 mm - 6"	tk 38261-50

Innendurchmesser 2.4 mm

Inner diameter 2.4 mm

Diamètre intérieur 2.4 mm

Diametro interno 2.4 mm

Diametro interno 2.4 mm



MC LAUGHLIN

	120 mm - 4¾"
3	tk 38265-03
5	tk 38265-05
7	tk 38265-07
12	tk 38265-12

Löcher

Holes

Trous

Orificios

Fori



tk 38266-00

Fixierschraube
Fixing screw

Vis de fixation
Tornillo de fijación

Vite di fissaggio

Instrumentarium für Schenkelhalsnägel
Instruments for femur nails

Instruments pour clous pour fémurs
Instrumentos para clavos para femures
 Strumenti per chiodi per collo del femore



210 mm - 8¼"

tk 38254-00

Vorschlaginstrument, Extraktor
Impactor, extractor

Impacteur, extracteur
Impactador, extractor
 Impattatore, estrattore



tk 38250-00

Nagelstarter
Nial starter

Impacteur
Impactador
 Impattatore



SVEN JOHANSSON

100 mm - 4"

tk 38256-00

Vorschlaginstrument
Nail driver

Impacteur
Impactador
 Impattatore



LLOYD

210 mm - 8¼"

tk 38252-00

Vorschlaginstrument, Extraktor
Impactor, extractor

Impacteur, extracteur
Impactador, extractor
 Impattatore, estrattore

Schenkelhalsnägels
Hip nails

Clous pour fémurs
Clavos para fémures
Chiodi per collo del femore

STAINLESS STEEL



Für 4,5 mm Kortikalis Schrauben
For 4.5 mm cortical screws
Pour vis corticales 4.5 mm
Para tornillos corticales de 4.5 mm
Per viti corticali di 4.5 mm

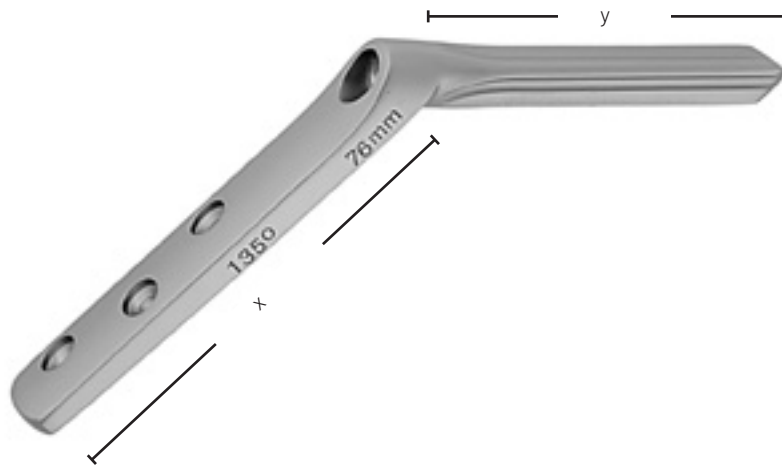

STANDARD-JEWETT 135°

	y = 57 mm - 2¼"	y = 63 mm - 2½"	y = 70 mm - 2¾"	y = 76 mm - 3"	y = 82 mm - 3¼"	y = 89 mm - 3½"
3 - x = 90 mm	tk 38292-57	tk 38292-63	tk 38292-70	tk 38292-76	tk 38292-82	tk 38292-89
5 - x = 130 mm	tk 38293-57	tk 38293-63	tk 38293-70	tk 38293-76	tk 38293-82	tk 38293-89
7 - x = 165 mm	tk 38294-57	tk 38294-63	tk 38294-70	tk 38294-76	tk 38294-82	tk 38294-89
10 - x = 220 mm	tk 38295-57	tk 38295-63	tk 38295-70	tk 38295-76	tk 38295-82	tk 38295-89
12 - x = 260 mm	tk 38296-57	tk 38296-63	tk 38296-70	tk 38296-76	tk 38296-82	tk 38296-89

	y = 95 mm - 3¾"	y = 102 mm - 4"	y = 108 mm - 4¼"	y = 114 mm - 4½"	y = 121 mm - 4¾"
3 - x = 90 mm	tk 38292-95	tk 38292-102	tk 38292-108	tk 38292-114	tk 38292-121
5 - x = 130 mm	tk 38293-95	tk 38293-102	tk 38293-108	tk 38293-114	tk 38293-121
7 - x = 165 mm	tk 38294-95	tk 38294-102	tk 38294-108	tk 38294-114	tk 38294-121
10 - x = 220 mm	tk 38295-95	tk 38295-102	tk 38295-108	tk 38295-114	tk 38295-121
12 - x = 260 mm	tk 38296-95	tk 38296-102	tk 38296-108	tk 38296-114	tk 38296-121

Löcher - Plattenlänge

Holes - plate length

Trous - longueur des plaques

Orificios - longitud de las placas

Fori - lunghezza della placca

Instrumentarium für Schenkelhalsnägel
Instruments for hip nails

Instruments pour clous fémurs
Instrumentos para clavos fémures
 Strumenti per collo del femore



tk 38250-00

Nagelstarter
Nial starter
 Impacteur
Impactador
 Impattatore



LLOYD

210 mm - 8¼"

tk 38252-00

Vorschlaginstrument, Extraktor
Impactor, extractor
 Impacteur, extracteur
Impactador, extractor
 Impattatore, estrattore



210 mm - 8¼"

tk 38254-00

Vorschlaginstrument, Extraktor
Impactor, extractor
 Impacteur, extracteur
Impactador, extractor
 Impattatore, estrattore

Knowles Nägel
Knowles pins

Clous Knowles
Clavos Knowles
Chiodi Knowles

STAINLESS STEEL

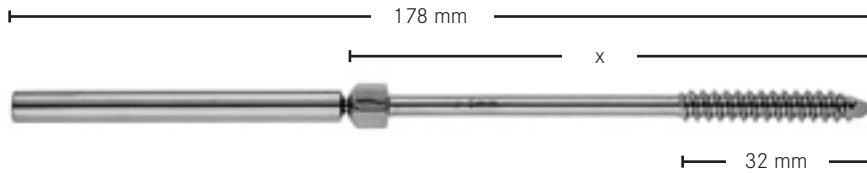

KNOWLES

x=	4.8 mm Ø
57 mm - 2¼"	tk 38292-01
63 mm - 2½"	tk 38292-02
70 mm - 2¾"	tk 38292-03
76 mm - 3"	tk 38292-04
82 mm - 3¼"	tk 38292-05
89 mm - 3½"	tk 38292-06
95 mm - 3¾"	tk 38292-07
102 mm - 4"	tk 38292-08
108 mm - 4¼"	tk 38292-09
114 mm - 4½"	tk 38292-10
121 mm - 4¾"	tk 38292-11
127 mm - 5"	tk 38292-12
133 mm - 5¼"	tk 38292-13
140 mm - 5½"	tk 38292-14
146 mm - 5¾"	tk 38292-15
152 mm - 6"	tk 38292-16



tk 38292-00

T-Schlüssel für Knowles Nägel
T-Wrench for Knowles pins

Clé en T pour clous Knowles
Llave en T para clavos Knowles
Chiave forma T per chiodi Knowles



ENDOSCOPY
ARTHROSCOPY



Arthroskopie | Arthroscopie
Arthroscopy | Artroscofia
 | Artroscopia



Bitte fordern Sie unseren Spezialkatalog an.
Please ask for our special catalogue.

Veuillez demander pour notre catalogue spécial.
Por favor preguntan para el catálogo especial.
Per favore domandate per il nostro catalogo speciale.

Dynamische Hüftschrauben - Implantat-Set
Dynamic hip screws implant set

Vis dynamiques de hanche, jeu d'implants
Tornillos dinámicos de cadera, juego de implantes
Vite dell'anca dinamiche, set impianto

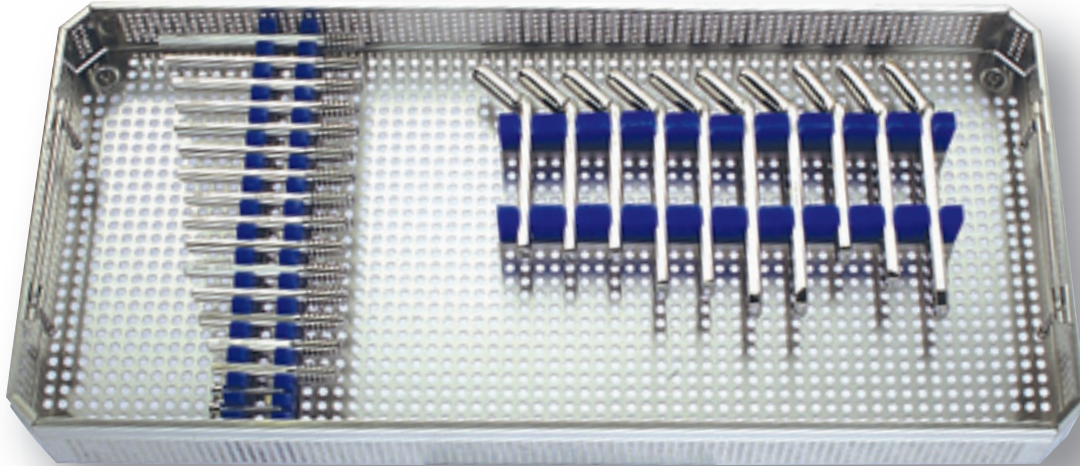

tk 38444-20

Dieser Satz beinhaltet Instrumente der Pos. 01-21, siehe Seite 35

This set contents the instruments acc. to pos. 01-21, see page 35

Ce jeu contient instruments des positions 01-21, voir page 35

Este juego contiene los instrumentos de las posiciones 01-21, vease pagina 35

Questo set contiene gli strumenti delle pos. 01-21, vedi pagina 35

Dynamische Hüftschrauben - Implantat-Set
Dynamic hip screws implant set

 Vis dynamiques de hanche, jeu d'implants
Tornillos dinámicos de cadera, juego de implantes
 Vite dell'anca dinamiche, set impianto

[pos 01]	<i>Container</i>	580 x 280 x 100 mm	tk 87170-1F-SI	1 x	→ 0 173
[pos 02]	<i>Tray</i>		tk 87050-52	1 x	
[pos 03]	<i>Dynamic lag screw, thread length 22 mm</i>	65 mm	tk 38312-50	1 x	→ 0 37
[pos 04]	<i>Dynamic lag screw, thread length 22 mm</i>	70 mm	tk 38312-55	1 x	→ 0 37
[pos 05]	<i>Dynamic lag screw, thread length 22 mm</i>	75 mm	tk 38312-60	1 x	→ 0 37
[pos 06]	<i>Dynamic lag screw, thread length 22 mm</i>	80 mm	tk 38312-65	1 x	→ 0 37
[pos 07]	<i>Dynamic lag screw, thread length 22 mm</i>	85 mm	tk 38312-70	2 x	→ 0 37
[pos 09]	<i>Dynamic lag screw, thread length 22 mm</i>	90 mm	tk 38312-75	2 x	→ 0 37
[pos 10]	<i>Dynamic lag screw, thread length 22 mm</i>	95 mm	tk 38312-95	2 x	→ 0 37
[pos 11]	<i>Dynamic lag screw, thread length 22 mm</i>	100 mm	tk 38312-00	2 x	→ 0 37
[pos 12]	<i>Dynamic lag screw, thread length 22 mm</i>	105 mm	tk 38312-05	1 x	→ 0 37
[pos 13]	<i>Dynamic lag screw, thread length 22 mm</i>	110 mm	tk 38312-10	1 x	→ 0 37
[pos 14]	<i>Dynamic lag screw, thread length 22 mm</i>	115 mm	tk 38312-15	1 x	→ 0 37
[pos 15]	<i>Compression screw</i>		tk 38313-00	3 x	→ 0 37
[pos 16]	<i>Dynamic hip screw plate, 135°, 4 holes</i>	78 mm	tk 38306-04	3 x	→ 0 36
[pos 17]	<i>Dynamic hip screw plate, 135°, 5 holes</i>	94 mm	tk 38306-05	2 x	→ 0 36
[pos 18]	<i>Dynamic hip screw plate, 135°, 6 holes</i>	110 mm	tk 38306-06	2 x	→ 0 36
[pos 19]	<i>Dynamic hip screw plate, 150°, 4 holes</i>	78 mm	tk 38309-04	1 x	→ 0 36
[pos 20]	<i>Dynamic hip screw plate, 150°, 5 holes</i>	94 mm	tk 38309-05	1 x	→ 0 36
[pos 21]	<i>Dynamic hip screw plate, 150°, 6 holes</i>	110 mm	tk 38309-06	1 x	→ 0 36

Dynamische Hüftplatten
Dynamic hip plates

Plaques pour vis de hanches dynamiques
Placas para tornillos de cadera dinámicos
Placche e viti di compressione

STAINLESS STEEL



Für 4,5 mm Kortikalis Schrauben
For 4.5 mm cortical screws
Pour vis corticales 4.5 mm
Para tornillos corticales de 4.5 mm
Per viti corticali di 4.5 mm diametro



	125°	130°	135°	140°	145°	150°
2			tk 38306-02			tk 38309-02
4	tk 38304-04	tk 38305-04	tk 38306-04	tk 38307-04	tk 38308-04	tk 38309-04
5	tk 38304-05	tk 38305-05	tk 38306-05	tk 38307-05	tk 38308-05	tk 38309-05
6	tk 38304-06	tk 38305-06	tk 38306-06	tk 38307-06	tk 38308-06	tk 38309-06
8			tk 38306-08			tk 38309-08
10			tk 38306-10			tk 38309-10
12			tk 38306-12			tk 38309-12
14			tk 38306-14			
16			tk 38306-16			

Löcher
Holes
Trous
Orificios
Fori

Dynamische Hüftplatten
Dynamic hip plates
Plaques pour vis de hanches dynamiques
Placas de autocompresión
Placche di dinamiche di compressione



tk 38310-00

Trochanterplatte
Trochanter plate

Plaque pour l'os trochanter
Placa para el hueso trochanter
Placca per osso trocanterico

Kompressionsschrauben
Compression screws

Vis de compression
Tornillos de compresión
Viti di compressione

STAINLESS STEEL

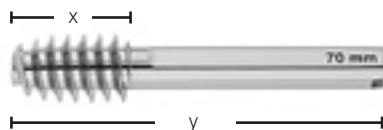

y =	x = 22mm
50 mm - 2 "	tk 383 12-50
55 mm - 2¼ "	tk 383 12-55
60 mm - 2½ "	tk 383 12-60
65 mm - 2½ "	tk 383 12-65
70 mm - 2¾ "	tk 383 12-70
75 mm - 3 "	tk 383 12-75
80 mm - 3¼ "	tk 383 12-80
85 mm - 3¼ "	tk 383 12-85
90 mm - 3½ "	tk 383 12-90
95 mm - 3¾ "	tk 383 12-95
100 mm - 4 "	tk 383 12-00
105 mm - 4¼ "	tk 383 12-05
110 mm - 4¼ "	tk 383 12-10
115 mm - 4½ "	tk 383 12-15
120 mm - 4¾ "	tk 383 12-20
125 mm - 5 "	tk 383 12-25
130 mm - 5 "	tk 383 12-30
135 mm - 5¼ "	tk 383 12-35
140 mm - 5½ "	tk 383 12-40
145 mm - 5¾ "	tk 383 12-45

Knochenschraube

Bone screw

Vis de fixation

Tornillo de fijación

Viti di compressione



tk 383 13-00

Kompressionsschraube

Compression screw

Vis à compression

Tornillo de compresión

Vite di compressione

Dynamische Kondylenplatten
Dynamic condylar plates

Plaques pour condyles dynamiques
Placas dinámicas para cóndilos
Placche dinamiche condiliche

STAINLESS STEEL



Für 4,5 mm Kortikalis Schrauben
For 4.5 mm cortical screws
Pour vis corticales 4.5 mm
Para tornillos corticales de 4.5 mm
Per viti corticali di 4.5 mm

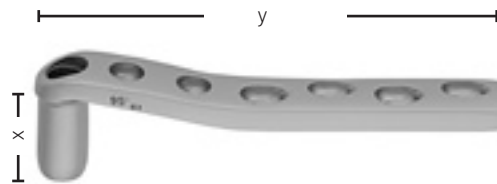

y =		x = 25mm
100 mm - 4 "	6	tk 383 10-06
130 mm - 5 "	8	tk 383 10-08
163 mm - 6½ "	10	tk 383 10-10
198 mm - 7¾ "	12	tk 383 10-12
225 mm - 8¾ "	14	tk 383 10-14
260 mm - 10¼ "	16	tk 383 10-16
306 mm - 12 "	18	tk 383 10-18
338 mm - 13¼ "	20	tk 383 10-20
370 mm - 14½ "	22	tk 383 10-22

Dynamische Kondylenplatten - 95°
Dynamic condylar plates - 95°

Plaques pour condyles dynamiques - 95°
Placas dinámicas para cóndilos - 95°
Placche condiliche dinamiche per condyllo -95°



tk 383 17-10

Bohrführung
Drill guide
Guide de perçage
Guía de perforación
Guida perforatore

Dynamische Kondylenschrauben
Dynamic condylar screws

Vis dynamiques pour condyles
Tornillos dinámicos para condilos
Viti condiliche dinamichi

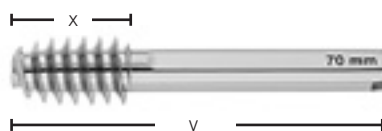

y =	x = 22mm
50 mm - 2"	tk 383 12-50
55 mm - 2 1/4"	tk 383 12-55
60 mm - 2 1/4"	tk 383 12-60
65 mm - 2 1/2"	tk 383 12-65
70 mm - 2 3/4"	tk 383 12-70
75 mm - 3"	tk 383 12-75
80 mm - 3 1/4"	tk 383 12-80
85 mm - 3 1/4"	tk 383 12-85

Knochenschraube
Bone screw

Vis de fixation
Tornillo de fijación
Viti di fissaggio



135°	tk 383 17-12
140°	tk 383 17-14
145°	tk 383 17-16
150°	tk 383 17-18

Bohrführung
Drill guide

Guide de perçage
Guía de perforación
Guida per perforazione

Set für dyn. Kondylenschrauben und -platten
Set for dynamic hip and condylar screws and plates

Jeu des vis dynamiques et plaques pour condyles
Juego de tornillos dinamicos y placas para condilos
Set per viti e placche condiliche dinamiche

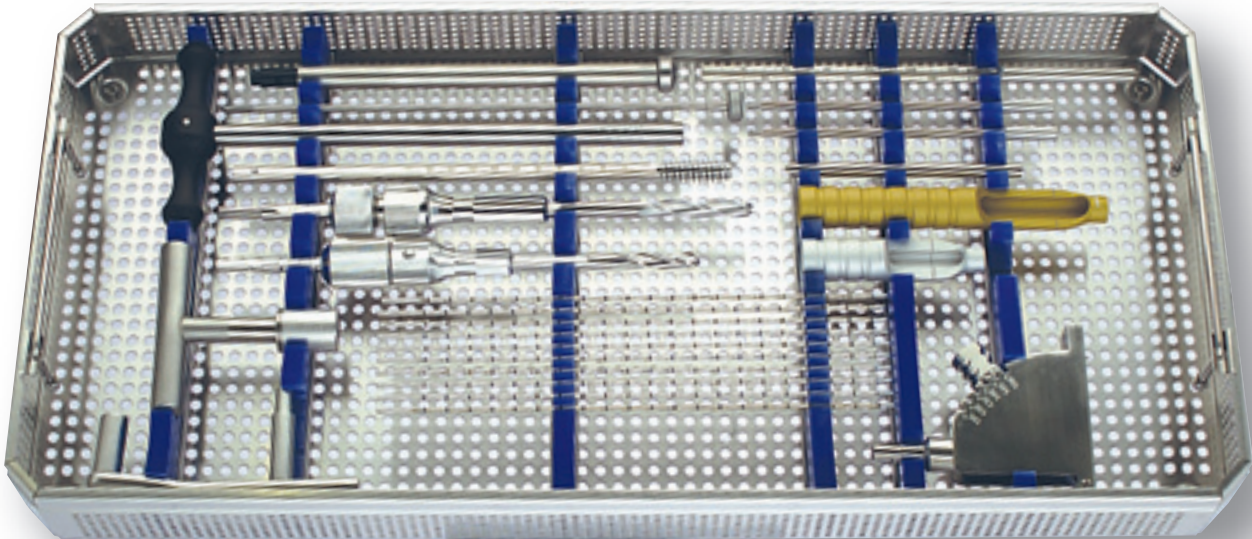

tk 38297-00

Dieser Satz beinhaltet Instrumente der Pos. 01-18, siehe Seite 41

This set contents the instruments acc. to pos. 01-18, see page 41

Ce jeu contient instruments des positions 01-18, voir page 41

Este juego contiene los instrumentos de las posiciones 01-18, veasé pagina 41

Questo set contiene gli strumenti delle pos. 01-18, vedi pagina 41

Set für dyn. Kondylenschrauben und -platten
Set for dynamic hip and condylar screws and plates

Jeu des vis dynamiques et plaques pour condyles
 Juego de tornillos dinamicos y placcas para condilos
 Set per viti e placche condiliche dinamiche

[pos 01]	<i>Container</i>	580 x 280 x 100 mm	tk 87170-1F-SI	1 x	→ O 173
[pos 02]	<i>Tray</i>		tk 87050-54	1 x	
[pos 03]	<i>Calibrated threaded guide pin, 2.5 mm Ø</i>	230 mm	tk 38297-23	10x	→ O 42
[pos 04]	<i>Drill guide, adjustable</i>		tk 38299-00	1 x	→ O 43
[pos 05]	<i>Measuring gauge</i>		tk 38297-50	1 x	→ O 42
[pos 06]	<i>Triple reamer for dynamic hip plate system, complete</i>		tk 38297-60	1 x	→ O 42
[pos 07]	<i>Tap</i>		tk 38298-00	1 x	→ O 42
[pos 09]	<i>Guide sleeve, short for tapping</i>		tk 38300-00	1 x	→ O 43
[pos 10]	<i>Guide sleeve, long for screwing in of lag screws</i>		tk 38300-01	1 x	→ O 43
[pos 11]	<i>Guide shaft for insertion of coupling screws</i>		tk 38300-40	1 x	→ O 45
[pos 12]	<i>Coupling screw for femoral dynamic hip screws</i>		tk 38300-10	1 x	→ O 44
[pos 13]	<i>Guide shaft</i>		tk 38300-50	1 x	→ O 45
[pos 14]	<i>Wrench</i>		tk 38300-30	1 x	→ O 44
[pos 15]	<i>Impactor</i>		tk 38300-20	1 x	→ O 44
[pos 16]	<i>Handle</i>		tk 38301-00	1 x	→ O 45
[pos 17]	<i>Drill guide 95°</i>		tk 38317-10	1 x	→ O 38
[pos 18]	<i>Triple reamer for dynamic condylar system, complete</i>		tk 38297-55	1 x	→ O 42

Instrumentarium für dyn. Kondylenschrauben und -platten
Instruments for dynamic hip and condylar screws and plates

Instruments pour vis dynamiques et plaques pour condyles
Instrumentos para tornillos dinamicos y placas para condilos
 Strumenti per viti e placche condiliche dinamiche



	2.5 mm Ø
	10 mm thread
230 mm - 9"	tk 38297-23

Führungsdraht
Calibrated threaded guide pin
 Fil de guidage calibré
Alambre de guía calibrado
 Filo guida, calibrato



tk 38297-50

Meßstab
Measuring gauge
 Règle
Regla
 Misuratore



short	long
tk 38297-55	tk 38297-60

Dreistufenbohrer, komplett
Triple reamer, complete
 Triple-mèche, complet
Taladro triple completo
 Perforatore triplice, completo



tk 38298-00

Gewindeschneider
Tap
 Taraud
Roscador
 Maschiatore

Instrumentarium für dyn. Kondylenschrauben und -platten
Instruments for dynamic hip and condylar screws and plates

Instruments pour vis dynamiques et plaques pour condyles
Instrumentos para tornillos dinámicos y placas para condilos
 Strumenti per viti e placche condiliche dinamiche



135° / 140° / 145° / 150°

tk 38299-00

Führungsvorrichtung, verstellbar
Drill guide, adjustable

Guidage de perforation, réglable

Guía de perforación, ajustable

Guida per perforare, regolabile



tk 38300-00

Zentrierhülse für Gewindeschneider, kurz
Guide sleeve for tap, short

Guidage pour taraud, courte

Guía para roscador, corta

Guida per centrare a viti, corta



tk 38300-01

Zentrierhülse zum Einschrauben, lang
Guide sleeve for screwing in of the traction screws, long

Guidage pour l'insert des vis, longue

Guía para fijar tornillos, larga

Guida per centrare le viti, grande

Instrumentarium für dyn. Kondylenschrauben und -platten
Instruments for dynamic hip and condylar screws and plates

Instruments pour vis dynamiques et plaques pour condyles
Instrumentos para tornillos dinamicos y placas para condilos
Strumenti per viti e placche condiliche dinamiche



tk 38300-10

Verbindungsschraube zur Schraubenentfernung
Coupling screw for femoral dynamic hip screw

Tige fileté pour retirer des vis
Tija roscada para sacar tornillos
Vite di collegamento per estarre "hip screws"



tk 38300-20

Einschlagbolzen
Impactor

Impacteur
Impactador
Impattatore



tk 38300-30

Schlüssel zum Einsetzen der Schrauben
Wrench to insert screws

Clé pour l'insert des vis
Llave para posicionar tornillos
Chiave per inserire "hip screws"

Instrumentarium für dyn. Kondylenschrauben und -platten
Instruments for dynamic hip and condylar screws and plates

Instruments pour vis dynamiques et plaques pour condyles
Instrumentos para tornillos dinamicos y placas para condilos
 Strumenti per viti e placche condiliche dinamiche



tk 38300-40

Führungsschaft
Guide shaft

Tige de guidage
Tija de guía
 Camicia di guida



tk 38300-50

Führungsschaft
Guide shaft

Tige de guidage
Tija de guía
 Camicia di guida



tk 38301-00

Handgriff
Handle

Poignée
Mango
 Manico

Instrumenten-Set für Winkelplatten
Instrument set for angled plates

Jeu d'instruments pour plaques angulaires
Juego de instrumentos para placas anguladas
Set di strumenti per placche angolate

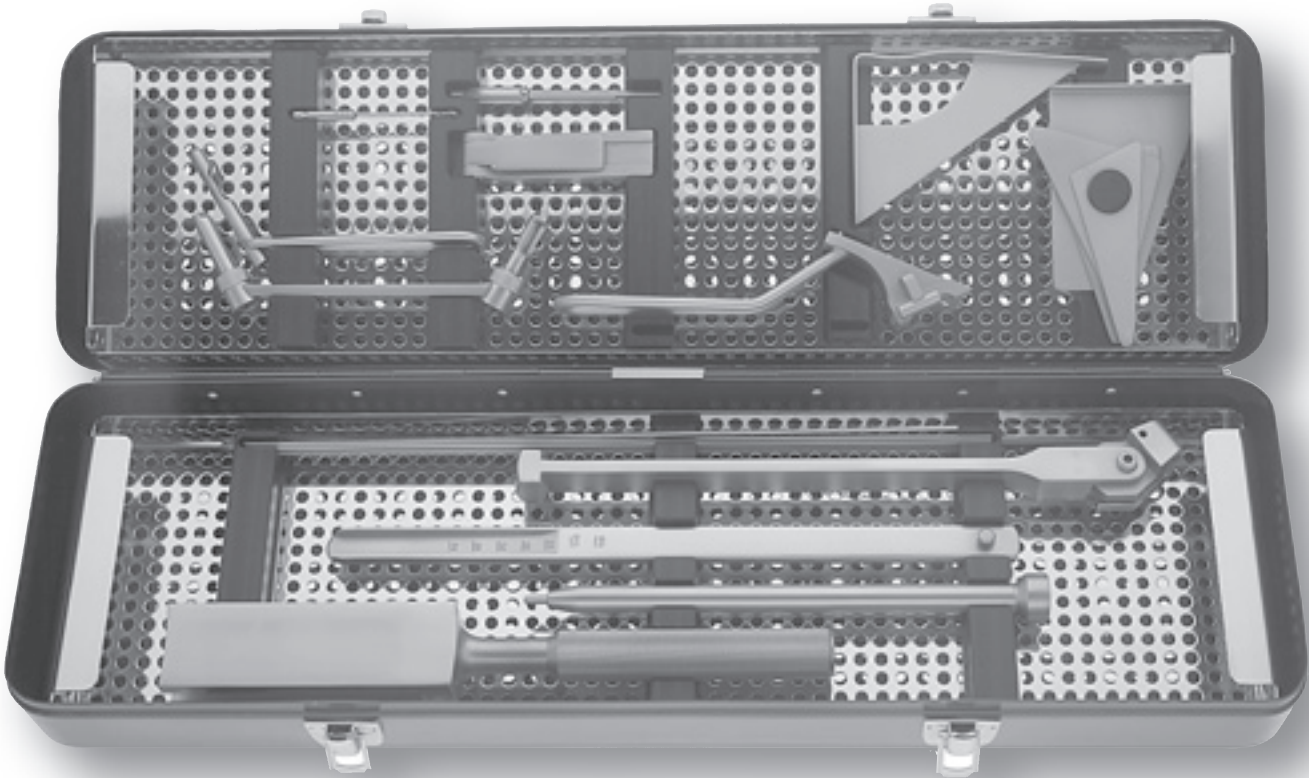

tk38443-10

Dieser Satz beinhaltet Instrumente der Pos. 01-20, siehe Seite 47

This set contents the instruments acc. to pos. 01-20, see page 47

Ce jeu contient instruments des positions 01-20, voir page 47

Este juego contiene los instrumentos de las posiciones 01-20, veasé pagina 47

Questo set contiene gli strumenti delle pos. 01-20, vedi pagina 47

Instrumenten-Set für Winkelplatten
Instrument set for angled plates

 Jeu d'instruments pour plaques angulaires
Juego de instrumentos para placas anguladas
 Set di strumenti per placche angolate

[pos 01]	<i>Container</i>	495 x 140 x 80 mm	tk 87235-1F-RE	1 x	
[pos 02]	<i>Upper tray</i>	470 x 130 x 30 mm	tk 87070-00	1 x	
[pos 03]	<i>Lower tray</i>	470 x 130 x 30 mm	tk 87070-01	1 x	
[pos 04]	<i>Triple drill guide for angular plates 130°</i>	160 mm	tk 38317-03	1 x	→ 0 51
[pos 05]	<i>Drill guide for round hole plates</i>	130 mm	tk 38317-02	1 x	→ 0 51
[pos 06]	<i>Reamer with quick coupling</i>	90 mm	tk 38317-06	1 x	→ 0 52
[pos 07]	<i>Guide plates for angular plates</i>	80 mm	tk 38317-04	1 x	→ 0 52
[pos 09]	<i>Seating chisel</i>	285 mm	tk 38318-30	1 x	→ 0 53
[pos 10]	<i>Insertor / extractor</i>	270 mm	tk 38318-20	1 x	→ 0 53
[pos 11]	<i>Slotted mallet</i>	270 mm	tk 38318-10	1 x	→ 0 53
[pos 12]	<i>Impactor</i>	205 mm	tk 38317-05	1 x	→ 0 52
[pos 13]	<i>Triangular positioning plate 80°/70°/30°</i>		tk 38319-03	1 x	→ 0 54
[pos 14]	<i>Triangular positioning plate 100°/60°/20°</i>		tk 38319-02	1 x	→ 0 54
[pos 15]	<i>Quadrangular positioning plate 110°/90°/90°/70°</i>		tk 38319-01	1 x	→ 0 54
[pos 16]	<i>Condylar plate guide</i>		tk 38319-05	1 x	→ 0 54
[pos 17]	<i>Drill guide for angular plates</i>	60 mm	tk 38317-01	1 x	→ 0 51
KIRSCHNER [pos 18]	<i>Wire drill, trocar/round, 2.0 mm Ø</i>	310 mm	tk 38456-20	10x	→ 0 139
[pos 19]	<i>Drill bit, 2.0 mm Ø, AO-shaft</i>	100 / 75 mm	tk 38488-03	1 x	→ 0 58
[pos 20]	<i>Triangular positioning plate 90°/50°/40°</i>		tk 38319-04	1 x	→ 0 54

Winkel-Kompressionsplatten
Angular compression plates

Plaques de compression angulaires
Placas de autocompresión anguladas
Placche di compressione, angolate

STAINLESS STEEL



Für 4,5 mm Kortikalis Schrauben
For 4.5 mm cortical screws
Pour vis corticales 4.5 mm
Para tornillos corticales de 4.5 mm
Per viti corticali di 4.5 mm

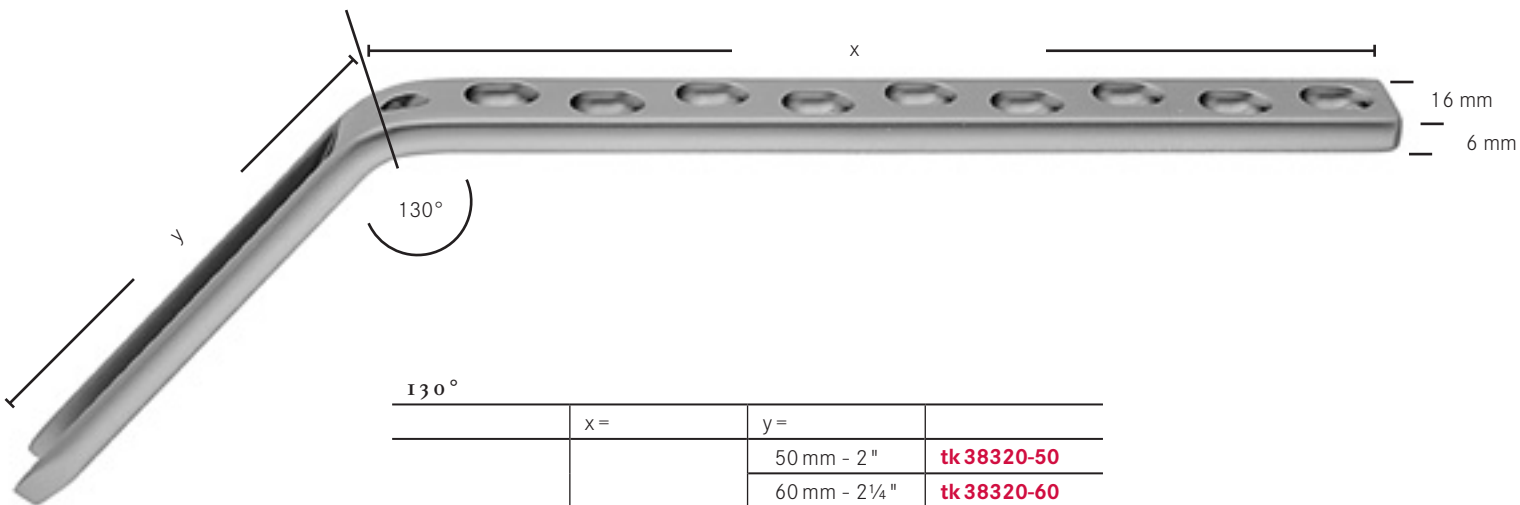

130°			
	x =	y =	
4	75 mm - 3"	50 mm - 2"	tk 38320-50
		60 mm - 2¼"	tk 38320-60
		70 mm - 2¾"	tk 38320-70
		75 mm - 3"	tk 38320-75
		80 mm - 3¼"	tk 38320-80
		85 mm - 3¼"	tk 38320-85
		90 mm - 3½"	tk 38320-90
		95 mm - 3¾"	tk 38320-95
6	104 mm - 4"	50 mm - 2"	tk 38323-50
		60 mm - 2¼"	tk 38323-60
		70 mm - 2¾"	tk 38323-70
		80 mm - 3¼"	tk 38323-80
		90 mm - 3½"	tk 38323-90
9	152 mm - 6"	70 mm - 2¾"	tk 38326-70
		80 mm - 3¼"	tk 38326-80
		90 mm - 3½"	tk 38326-90
12	200 mm - 8"	70 mm - 2¾"	tk 38328-70
		80 mm - 3¼"	tk 38328-80
		90 mm - 3½"	tk 38328-90

Löcher

Holes

Trous

Orificios

Fori

Winkel-Kompressionsplatten
Angular compression plates

Plaques de compression angulaires
Placas de autocompresión anguladas
 Placche di compressione, angolate

STAINLESS STEEL



Für 4,5 mm Kortikalis Schrauben
For 4.5 mm cortical screws
 Pour vis corticales 4.5 mm
Para tornillos corticales de 4.5 mm
 Per viti corticali di 4.5 mm diametro

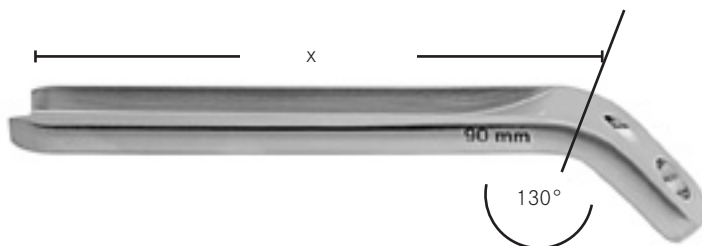

130°		
	x =	
1	70 mm - 2¾"	tk 38329-70
	75 mm - 3"	tk 38329-75
	80 mm - 2¾"	tk 38329-80
	85 mm - 3¼"	tk 38329-85
	90 mm - 3½"	tk 38329-90
	95 mm - 3¾"	tk 38329-95
	100 mm - 4"	tk 38329-00
	105 mm - 4¼"	tk 38329-05
	110 mm - 4¼"	tk 38329-10

Löcher
Holes
 Trous
Orificios
 Fori

Kondylen-Platten
Condylar plates

Plaques condilaires
Placas condilares
Placche per condylilli

STAINLESS STEEL



Für 4,5mm Kortikalis Schrauben
For 4.5mm cortical screws
Pour vis corticales 4.5mm
Para tornillos corticales de 4.5 mm
Per viti corticali di 4.5 mm

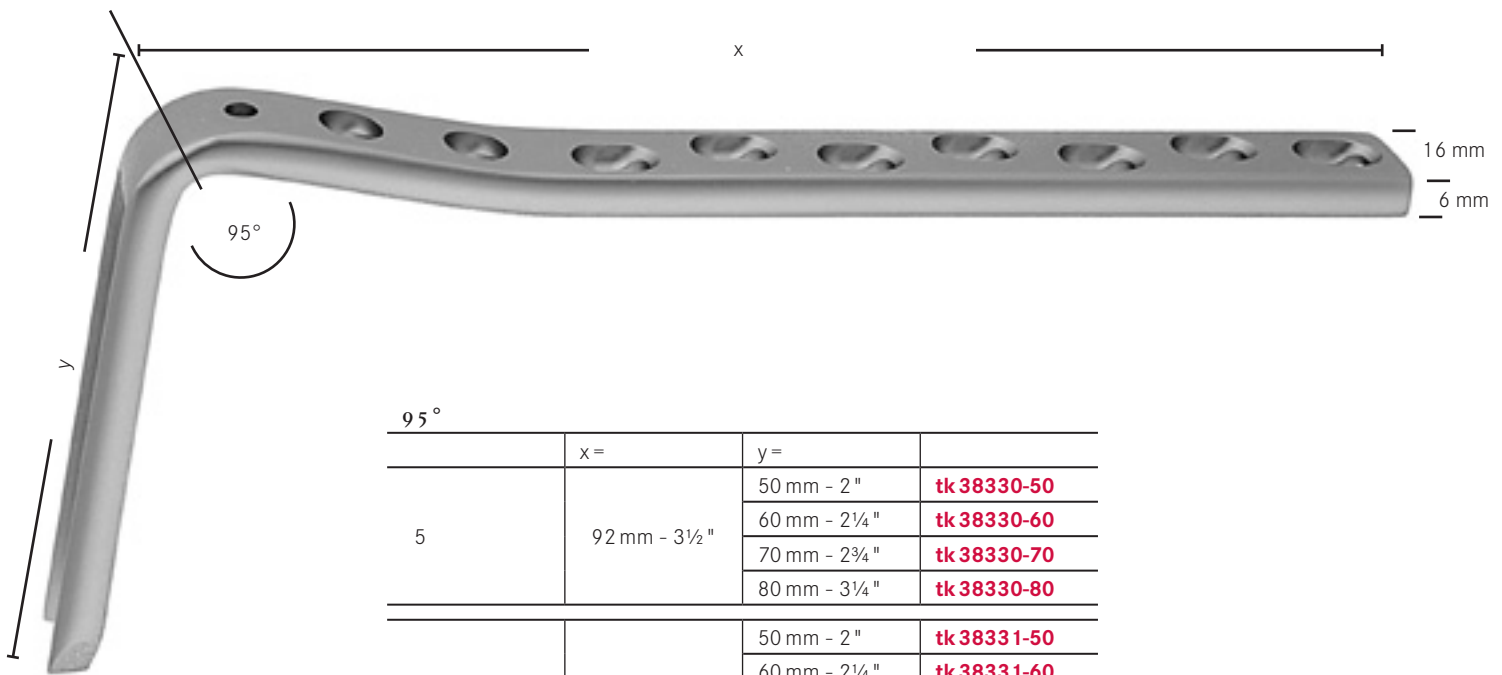

95°			
	x =	y =	
5	92 mm - 3½"	50 mm - 2"	tk 38330-50
		60 mm - 2¼"	tk 38330-60
		70 mm - 2¾"	tk 38330-70
		80 mm - 3¼"	tk 38330-80
7	124 mm - 5"	50 mm - 2"	tk 38331-50
		60 mm - 2¼"	tk 38331-60
		70 mm - 2¾"	tk 38331-70
		80 mm - 3¼"	tk 38331-80
9	156 mm - 6¼"	50 mm - 2"	tk 38332-50
		60 mm - 2¼"	tk 38332-60
		70 mm - 2¾"	tk 38332-70
		80 mm - 3¼"	tk 38332-80
12	204 mm - 8"	50 mm - 2"	tk 38333-50
		60 mm - 2¼"	tk 38333-60
		70 mm - 2¾"	tk 38333-70
		80 mm - 3¼"	tk 38333-80

Löcher
Holes
Trous
Orificios
Fori

Instrumentarium für Winkelplatten
Instruments for angled plates

Instruments pour plaques angulaires
Instrumentos para placas anguladas
 Strumenti per placche angolate



	165 mm - 6½"
3.2 mm Ø	tk 383 17-01

Spannbohrbüchse für Winkelplatten
Drill guide for angular plates

Guide de perçage pour plaques angulaires
Guía de perforación para placas anguladas
 Guida di perforazione per placche angolate



	130 mm - 5"
3.3 mm Ø	tk 383 17-02

Bohrbüchse für Rundlochplatten
Drill guide for round hole plates

Guide de perforation pour plaques avec trous ronds
Guía de perforación para placas con orificos redondos
 Guida di perforazione per placche con fori rotondi



	160 mm - 6¼"
3.2 mm Ø	tk 383 17-03

Zielgerät mit Aufsatz für Winkelplatten 130°
Drill guide for angular plates 130°

Guide de perforation pour plaques angulaires de 130°
Guía de perforación para placas anguladas de 130°
 Guida di perforazione per placche angolate di 130°

Instrumentarium für Winkelplatten
Instruments for angled plates

Instruments pour plaques angulaires
Instrumentos para placas anguladas
Strumenti per placche angolate



	80 mm - 3¼"
3.2 mm Ø	tk 38317-04

Führungsplatte für Winkelplatten
Guide plate for angular plates
Guide pour plaques angulaires
Guía para placas anguladas
Guida per placche angolate



	205 mm - 8"
	tk 38317-05

Nachschlaginstrument
Impactor
Impacteur
Impactador
Impattore



	90 mm - 3½"
4.5 mm Ø	tk 38317-06

Zapfenfräser mit Schnellkupplung
Reamer with quick coupling
Fraise avec raccord rapide
Fresa con acoplamiento rapido
Fresa con accoppiamento rapido

Instrumentarium für Winkelplatten
Instruments for angled plates

Instruments pour plaques angulaires
Instrumentos para placas anguladas
 Strumenti per placche angolate



270 mm - 10½"

tk 38318-10

Schlitzhammer
Slotted mallet

Marteau fendé
Martillo hendido
 Martello



270 mm - 10½"

tk 38318-20

Ein- Ausschlaginstrument
Insertor, extractor

Impacteur, extracteur
Impactador, extractor
 Impattore, estratore



285 mm - 11¼"

tk 38318-30

Plattensetzinstrument
Seating chisel for preparing blade channel

Instrument pour positionner des plaques
Guía para posicionar las placas
 Strumento per posizionare le placche

Instrumentarium für Winkelplatten
Instruments for angled plates

Instruments pour plaques angulaires
Instrumentos para placas anguladas
Strumenti per placche angolare



110° / 90° / 90° / 70° | **tk 38319-01**

Zielplatte, viereckig
Positioning plate, quadrangular
Plaque à positionner rectangulaire
Placa para apuntar, cuadrangular
Placca per posizionare, quadroangolare



100° / 60° / 20° | **tk 38319-02**

Zielplatte, dreieckig
Positioning plate, triangular
Plaque à positionner, triangulaire
Placa para apuntar, triangular
Placca per posizionare, triangolare



80° / 70° / 30° | **tk 38319-03**

Zielplatte, dreieckig
Positioning plate, triangular
Plaque à positionner, triangulaire
Placa para apuntar, triangular
Placca per posizionare, triangolare



90° / 50° / 40° | **tk 38319-04**

Zielplatte, dreieckig
Positioning plate, triangular
Plaque à positionner, triangulaire
Placa para apuntar, triangular
Placca per posizionare, triangolare



tk 38319-05

Kondylen Zielgerät
Condylar plate guider
Guide pour plaques condyles
Guía para placas para cóndilos
Guida per placche per condiliche



ENDOSCOPY
LUMBAR DISCECTOMY SYSTEM

System zur lumbalen Diskektomie
Lumbar discectomy system

Système pour la discectomie lombaire
Sistema para la discectomia lumbar
Sistema per la discectomia lombare



Bitte fordern Sie unseren Spezialkatalog an.
Please ask for our special catalogue.

Veillez demander pour notre catalogue spécial.
Por favor preguntan para el catálogo especial.

Per favore domandate per il nostro catalogo speciale.

Basis Instrumentensatz für Schrauben und Platten
Basic instrument set for screws and plates

Jeu d'instruments de base pour vis et plaques
Juego de instrumentos de base para tornillos y placas
Set di strumentario di base per viti e placche

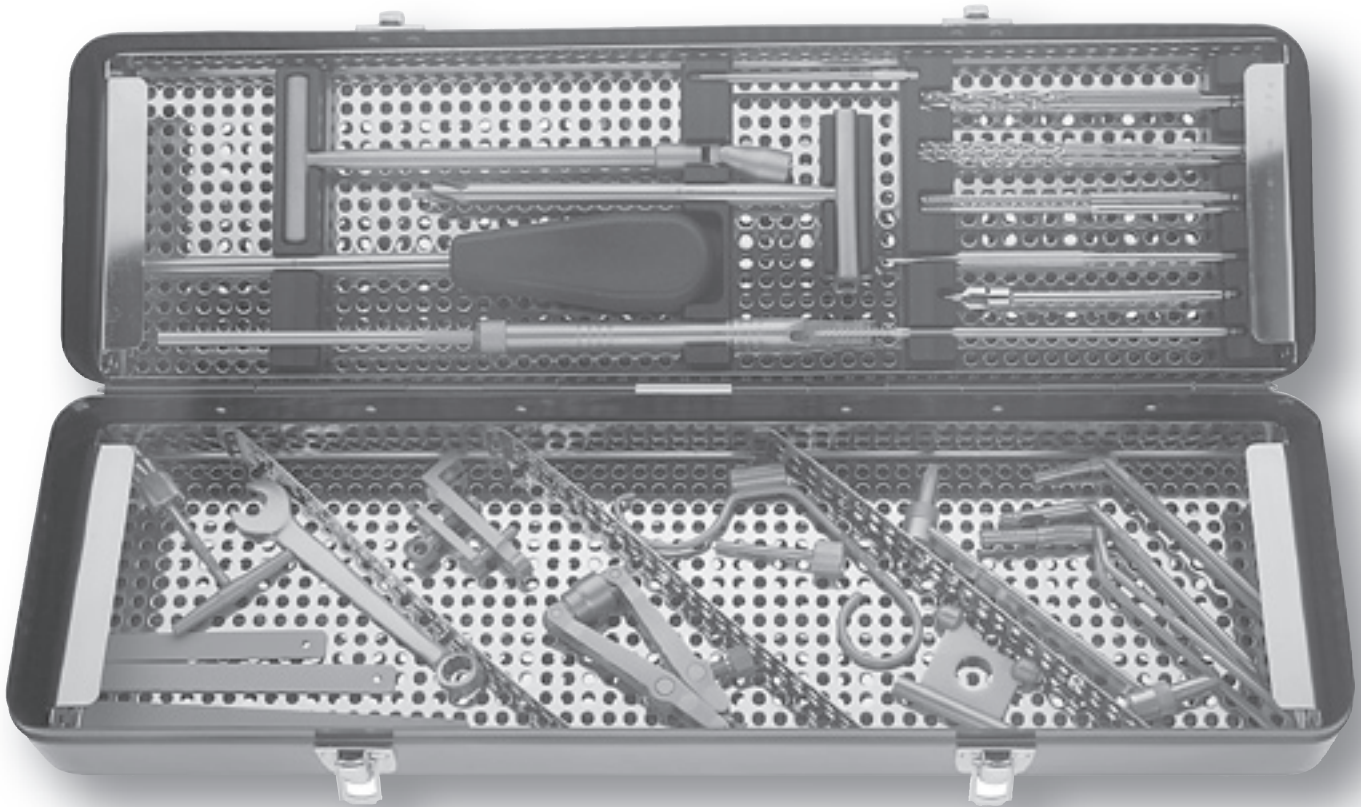

tk 38444-30

Dieser Satz beinhaltet Instrumente der Pos. 01-29, siehe Seite 57

This set contents the instruments acc. to pos. 01-29, see page 57

Ce jeu contient instruments des positions 01-29, voir page 57

Este juego contiene los instrumentos de las posiciones 01-29, veasé pagina 57

Questo set contiene gli strumenti delle pos. 01-29, vedi pagina 57

Basis Instrumentensatz für Schrauben und Platten
Basic instrument set for screws and plates

Jeu d'instruments de base pour vis et plaques
 Juego de instrumentos de base para tornillos y placas
 Set di strumentario di base per viti e placche

[pos 01]	Container	495 x 140 x 80 mm	tk87235-1F-RE	1 x	
[pos 02]	Upper tray	470 x 130 x 30 mm	tk87070-02	1 x	
[pos 03]	Lower tray	470 x 130 x 30 mm	tk87070-03	1 x	
[pos 04]	Drill bit, AO-shaft, 3.2 mm Ø	150 / 120 mm	tk38488-06	3x	→ 0 58
[pos 05]	Drill bit, AO-shaft, 4.5 mm Ø	150 / 120 mm	tk38488-10	2x	→ 0 58
[pos 06]	Countersink for malleolar screws, 3.2 mm Ø	120 mm	tk38389-12	1 x	→ 0 62
[pos 07]	Handle for taps with AO-shaft		tk38388-00	1 x	→ 0 59
[pos 09]	Tap with AO-shaft, for screws 4.5 mm Ø with long thread	130 mm	tk38489-38	1 x	→ 0 59
[pos 10]	Tap with AO-shaft, for screws 6.5 mm Ø	170 mm	tk38489-65	1 x	→ 0 59
[pos 11]	Tap sleeve, for screws 3.5 mm Ø	35 mm	tk38391-04	1 x	→ 0 60
[pos 12]	Insert drill sleeve for screws 4.5 mm Ø	58 mm	tk38392-45	1 x	→ 0 61
[pos 13]	Tap sleeve 4.5 mm Ø		tk38391-05	1 x	→ 0 60
[pos 14]	Pointed drill guide	150 mm	tk38391-06	1 x	→ 0 61
[pos 15]	Screw driver for hexagonal head 3.5 mm Ø	200 mm	tk38542-35	1 x	→ 0 62
[pos 16]	Screw driver with quick coupling for hexagonal head 3.5 mm Ø	200 mm	tk38542-01	1 x	→ 0 62
[pos 17]	Depth gauge for 4.5 mm and 6.5 mm screws	260 mm	tk38397-03	1 x	→ 0 63
[pos 18]	Sharp hook	150 mm	tk38398-15	1 x	→ 0 63
[pos 19]	Drill sleeve for tension device, 3.2 mm Ø		tk38319-20	1 x	→ 0 62
[pos 20]	Drill guide for round hole plates, 3.2 mm Ø		tk38391-10	1 x	→ 0 60
[pos 21]	Compression device		tk38319-25	1 x	→ 0 65
[pos 22]	Tension device		tk38319-26	1 x	→ 0 65
[pos 23]	Socket wrench, 11 mm		tk38300-35	1 x	→ 0 62
[pos 24]	Combination wrench, 11 mm		tk38541-00	1 x	→ 0 63
[pos 25]	Neutral and load drill guide, 4.5 mm Ø		tk38392-03	1 x	→ 0 61
[pos 26]	Bending template, 5 holes		tk38541-05	1 x	→ 0 63
[pos 27]	Bending template, 7 holes		tk38541-07	1 x	→ 0 63
[pos 28]	Bending template, 9 holes		tk38541-09	1 x	→ 0 63
[pos 29]	Countersink, 4.5 mm Ø	180 mm	tk38389-18	1 x	→ 0 62

Instrumente für Platten und Schrauben
Instruments for plates and screws
Instrumentos para placas y tornillos
Strumenti per placche e viti

1.1 mm Ø	65 / 35 mm	tk 38488-01
1.5 mm Ø	85 / 60 mm	tk 38488-02
2.0 mm Ø	100 / 75 mm	tk 38488-03
2.5 mm Ø	110 / 85 mm	tk 38488-04
2.7 mm Ø	100 / 75 mm	tk 38488-05
3.2 mm Ø	145 / 120 mm	tk 38488-06
3.2 mm Ø	195 / 170 mm	tk 38488-07
3.5 mm Ø	100 / 85 mm	tk 38488-08
3.5 mm Ø	195 / 170 mm	tk 38488-09
4.5 mm Ø	145 / 120 mm	tk 38488-10
4.5 mm Ø	195 / 170 mm	tk 38488-12

Spiralbohrer	Länge	AO Schaft
<i>Drills</i>	<i>Length</i>	<i>AO shank</i>
Mèches	Longueur	Raccord AO
Taladros	Longitud	Connector AO
Punte per trapano	Lunghezza	Attacco AO



1.1 mm Ø	45 / 30 mm	tk 38488-11
1.5 mm Ø	70 / 55 mm	tk 38488-15
2.0 mm Ø	85 / 70 mm	tk 38488-20
2.5 mm Ø	95 / 80 mm	tk 38488-25
2.7 mm Ø	85 / 70 mm	tk 38488-27
3.2 mm Ø	130 / 115 mm	tk 38488-32
3.2 mm Ø	180 / 165 mm	tk 38488-33
3.5 mm Ø	95 / 80 mm	tk 38488-35
3.5 mm Ø	180 / 165 mm	tk 38488-36
4.5 mm Ø	130 / 115 mm	tk 38488-40
4.5 mm Ø	180 / 165 mm	tk 38488-45

Spiralbohrer	Länge	Rundschaft
<i>Drills</i>	<i>Length</i>	<i>Round shank</i>
Mèches	Longueur	Tige ronde
Taladros	Longitud	Tija redonda
Punte per trapano	Lunghezza	Asta rotondo

Instrumente für Platten und Schrauben
Instruments for plates and screws

Instrumentos para plaques y vis
Strumenti per placche e viti



tk 38388-00

Griff für AO-Schaft
Tap handles for AO shaft

Poignée pour tiges AO
Mango para tija AO
Manico per taglia filetto attacco AO

tk 38388-01

Griff kanuliert
Tap handle cannulated

Poignée canelée
Mango acanalado
Manico canallato



1.5 mm Ø	tk 38489-15	-
2.0 mm Ø	tk 38489-20	-
2.7 mm Ø	tk 38489-27	tk 38489-01
3.5 mm Ø - 1.25 pitch	tk 38489-34	tk 38489-02
3.5 mm Ø - 1.75 pitch	tk 38489-35	tk 38489-03
4.0 mm Ø - 1.75 pitch	tk 38489-36	tk 38489-06
4.5 mm Ø - short thread	tk 38489-37	-
4.5 mm Ø - long thread	tk 38489-38	tk 38489-04
6.5 mm Ø	tk 38489-65	tk 38489-05

Gewindeschneider
Taps

Filières
Rascador
Taglia filetto

AO Schaft
AO shank
Raccord AO
Connector AO
Attacco AO

T-Griff
T-bar
Poignée en T
Mango en T
Manico a T

Instrumente für Platten und Schrauben
Instruments for plates and screws
Instrumentes pour plaques et vis
Instrumentos para placas y tornillos
Strumenti per placche e viti

3.5 mm Ø	tk 3839 1-04	-
4.5 mm Ø	-	tk 3839 1-05

Gewebeschutzhülse
Tap sleeve
für Gewindeschneider 2,7/3,5 mm Ø
for taps 2.7/3.5 mm Ø
für Gewindeschneider 6,5 mm Ø
for taps 6.5 mm Ø
Guide de perçage
pour tarauds de 2.7/3.5 mm Ø
pour tarauds de 6.5 mm Ø
Guía de perforación
para rascadores de 2.7/3.5 mm
para rascadores de 6.5 mm
Guida per taglia filetto
per taglia filetto 2.7/3.5 mm Ø
per taglia filetto 6.5 mm Ø

3.2 mm Ø	tk 3839 1-10
----------	---------------------

Bohrbüchse für Rundlochplatten
Drill guide for round hole plates
Guide de perforation pour plaques avec trous ronds
Guía de perforación para placas con orificos redondo
Guida di perforazione per placche con fori rotandi

Instrumente für Platten und Schrauben
Instruments for plates and screws

Instrumentos para plaques et vis
Instrumentos para placas y tornillos
Strumenti per placche e viti



tk 38392-00	1.5 mm Ø	2.0 mm Ø
tk 38392-01	2.0 mm Ø	2.7 mm Ø
tk 38392-02	2.5 mm Ø	3.5 mm Ø - fine thread
tk 38392-03	3.2 mm Ø	4.5 mm Ø

Neutral- und Spannbohrbüchsen
Neutral and load drill guides

für Bohrer
for drill bits

für Schrauben
for screws

Guide de perçage
Guías de perforación
Guida di perforazione

pour mèches
para brocas
per punte di trapano

pour vis
para tornillos
per viti



150 mm - 6"

tk 38391-06

Zielgerät
Pointed drill guide

Guide de perçage
Guía de perforación
Strumento di guida e mira



tk 38392-27	2.0 mm Ø	2.7 mm Ø
tk 38392-35	2.5 mm Ø	3.5 mm Ø
tk 38392-45	3.2 mm Ø	3.5 mm Ø - fine thread

Steckbohrbüchse
Insert drill sleeve

für Bohrer
for drill bits

für Kortikalis Schrauben
for cortical screws

Guides de perçage
Guías de perforación
Inserto guida

pour mèches
para brocas
per punte di trapano

pour vis corticales
para tornillos corticales
per viti corticali

Instrumente für Platten und Schrauben
Instruments for plates and screws

Instruments pour plaques et vis
Instrumentos para placas y tornillos
Strumenti per placche e viti



1.1 mm Ø	55 mm - 2¼"	1.5 - 2.0 mm Ø	tk 38389-05
2.0 mm Ø	70 mm - 2¾"	2.7 - 4.0 mm Ø	tk 38389-07
3.2 mm Ø	120 mm - 4¾"	Malleolar	tk 38389-12

Kopfraumfräser	Länge	für Schrauben
<i>Countersink</i>	<i>Length</i>	<i>for screws</i>
Mèches	Longueur	pour vis
<i>Brocas</i>	<i>Longitud</i>	<i>para tornillos</i>
Frese per testa vite	Lunghezza	per viti



180 mm - 7"

tk 38389-18

Kopfraumfräser für große Schrauben Ø 4,5/6,5 mm
Countersink for large screws Ø 4.5/6.5 mm

Mèches pour grandes vis Ø 4.5/6.5 mm
Brocas para tornillos largos Ø 4.5/6.5 mm
Frese per teste viti grande Ø 4.5/6.5 mm



	200 mm - 8"
3.5 mm	tk 38542-01

Sechskantschraubendreher mit Schnellkupplung
Screw driver for hexagonal head with quick coupling

Tourne-vis hexagonal avec connexion rapide
Destornillador hexagonal acoplamiento rapido
Giravite hexagonale, accoppiamento rapido



3.2 mm Ø	tk 38319-20
----------	--------------------

Bohrbüchse für Plattenhalter
Drill sleeve for tension

Guide de perçage pour porte-plaques
Guía de perforación para porta placas
Guida di perforazione per porta placche



	200 mm - 8"
3.5 mm	tk 38542-35

Sechskantschraubendreher
Screw driver for hexagonal head

Tourne-vis pour vis hexagonal
Destornillador hexagonal
Giravite esagonale



x = 11 mm	tk 38300-35
-----------	--------------------

Steckschlüssel
Socket wrench

Clé à pipe
Llave a vaso
Chiave a tubo

Instrumente für Platten und Schrauben
Instruments for plates and screws

Instrumentos para placas y tornillos
Strumenti per placche e viti



x = 11 mm

tk 38541-00

Ring- / Gabelschlüssel
Combination wrench

Clé plate

Llave a boca

Chiave a forcella a anello



170 mm - 6¾"	tk 38397-01	tk 38397-02	-
260 mm - 10¼"	-	-	tk 38397-03

Messinstrument <i>Depth gauge</i>	Mini-Schrauben <i>Mini screws</i>	Kleine Schrauben <i>Small screws</i>	Große Schrauben <i>Large screws</i>
Calibe de profondeur <i>Calibrador de proundidad</i>	Mini-vis <i>Mini-tornillos</i>	Petites vis <i>Pequeños tornillos</i>	Grandes vis <i>Gran tornillos</i>
Calibro di profondità	Viti mini	Viti piccoli	Viti grandi



150 mm - 6"

tk 38398-15

Haken, scharf
Hook, sharp
Crochet tranchant
Gancho cortante
Gancio, acuto



5	tk 38541-05
7	tk 38541-07
9	tk 38541-09

Löcher
Holes
Trous
Orificios
Fori

Biegelehre
Bending template
Calibre pour plier les plaques
Calibrador para doblar placas
Calibro per la piegatura delle placche



80 mm - 3¼"

tk 38399-08

Schraubenpinzette
Forceps for screws
Pince pour vis
Pinza para tornillos
Pinza porta viti

Instrumente für Platten und Schrauben
Instruments for plates and screws

Instrumentos para placas y vis
Strumenti per placche e viti



200 mm - 8" **tk38573-01**

Plattenbiegezange für Knochenplatten bis 2.0 mm Stärke
Plate bending plier for plates up to 2.0 mm

Pince à couder pour des plaques de 2.0 mm
Pinza para torcer, placas hasta 2.0 mm
Pinza piega placche fino a 2.0 mm

240 mm - 9½" **tk38573-02**

Plattenbiegezange für Knochenplatten von 2.7 bis 3.5 mm Stärke
Plate bending plier for plates from 2.7 up to 3.5 mm

Pince à couder pour des plaques de 2,7 á 3,5 mm
Pinza para torcer, para placas hasta de 2.7 hasta 3.5 mm
Pinza piega placche da 2.7 a 3.5 mm



240 mm - 9½" **tk38394-24**

Schränkeisen für Standardplatten
Bending iron for standard plates

Outil pour plier des plaques
Instrumento para placas doblar
Strumento per piegare placche standard



tk38395-00

Biegepresse
Bending press

Presse pour plier des plaques
Prensa para placas doblar
Pressa per piegare placche

Instrumente für Platten und Schrauben
Instruments for plates and screws

Instrumentos para placas y vis
 Strumenti per placche e viti



tk 383 19-26

Spannvorrichtung
Tension device
 Instrument de tension
Instrumento de estirar
 Tensionatore



tk 38541-02

Schlüssel für Spannvorrichtung
Pin wrench for tension device
 Clé pour instrument de tension
Llave para instrumento de estirar
 Chiave per tensionatore



x = 8 mm

tk 383 19-25

Kompressionsinstrument
Compression device
 Instruments de compression
Instrumentos de compresión
 Strumento per compressione

Schrauben Satz
Screw set

Jeu des vis
Juego de tornillos
Set di viti

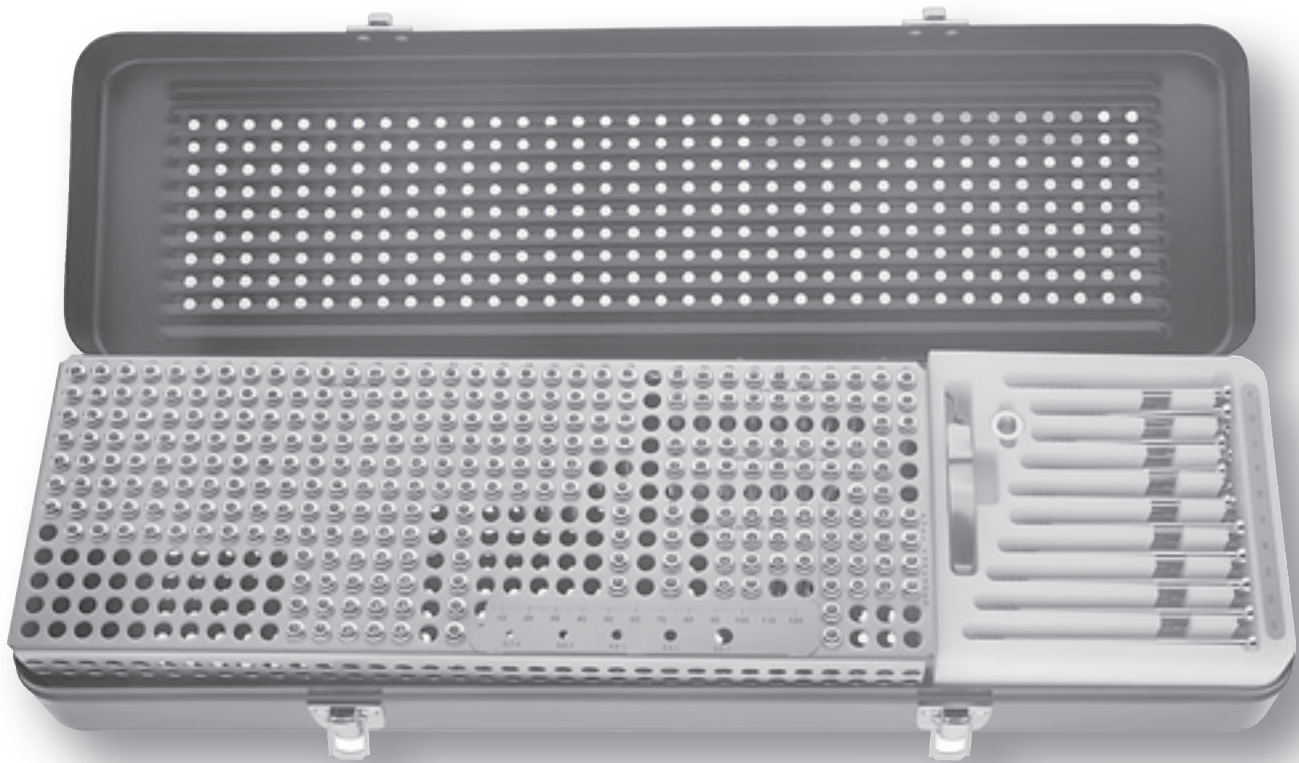

tk 38444-40

Dieser Satz beinhaltet Instrumente der Pos. 01-21, siehe Seite 67

This set contents the instruments acc. to pos. 01-21, see page 67

Ce jeu contient instruments des positions 01-21, voir page 67

Este juego contiene los instrumentos de las posiciones 01-21, veasé pagina 67

Questo set contiene gli strumenti delle pos. 01-21, vedi pagina 67

Schrauben Satz | Jeu des vis
Screw set | Juego de tornillos
Set di viti

[pos 01]	Container, red	495 x 140 x 80 mm	tk87235-1F-RE	1x	
[pos 02]	Tray (aluminium)	350 x 130 x 75 mm	tk87070-04	1x	
[pos 03]	Tray (plastic)	130 x 130 x 75 mm	tk87070-05	1x	
[pos 04]	Cortical screw 4.5 mm Ø 14 mm		tk38410-14	7x	→ 0 71
[pos 05]	Cortical screws 4.5 mm Ø 16 / 18 / 20 / 22 / 24 / 26 / 28 mm		tk38410-16 → -28	8x each (total 56 pcs.)	→ 0 71
[pos 06]	Cortical screw 4.5 mm Ø 30 mm		tk38410-30	16x	→ 0 71
[pos 07]	Cortical screws 4.5 mm Ø 32 / 34 / 36 / 38 / 40 / 44 mm		tk38410-32 → -44	12x each (total 72 pcs.)	→ 0 71
[pos 09]	Cortical screws 4.5 mm Ø 42 / 46 / 48 / 52 / 56 mm		tk38410-42 → -56	6x each (total 30 pcs.)	→ 0 71
[pos 10]	Cortical screw 4.5 mm Ø 60 mm		tk38410-60	5x	→ 0 71
[pos 11]	Cortical screws 4.5 mm Ø 64 / 70 mm		tk38410-65 → -70	4x each (total 8 pcs.)	→ 0 71
[pos 12]	Malleolar screws 4.5 mm Ø 25 / 30 / 35 / 40 / 45 / 50 / 55 / 60 mm		tk38412-20 → -60	2x each (total 16 pcs.)	→ 0 73
[pos 13]	Malleolar screws 4.5 mm Ø 65 / 70 mm		tk38412-65 → -70	3x each (total 6 pcs.)	→ 0 73
[pos 14]	Cancellous bone screws, 16 mm thread, 6.5 mm Ø 30 / 35 / 40 / 45 / 50 / 55 / 60 mm		tk38414-30 → -60	2x each (total 14 pcs.)	→ 0 70
[pos 15]	Cancellous bone screws, 16 mm thread, 6.5 mm Ø 65 / 70 / 75 / 80 / 85 / 90 / 95 / 100 / 105 / 110 mm		tk38414-65 → -10	3x each (total 30 pcs.)	→ 0 70
[pos 16]	Cancellous bone screws, 32 mm thread, 6.5 mm Ø 45 / 50 / 55 / 60 mm		tk38416-45 → -60	4x each (total 16 pcs.)	→ 0 70
[pos 17]	Cancellous bone screws, 32 mm thread, 6.5 mm Ø 65 / 70 / 80 / 90 mm		tk38416-65 → -90	3x each (total 12 pcs.)	→ 0 70
[pos 18]	Cancellous bone screw, full thread, 6.5 mm Ø 25 mm		tk38418-25	6x	→ 0 70
[pos 19]	Cancellous bone screw, full thread, 6.5 mm Ø 30 / 35 / 40 mm		tk38418-30 → -40	4x each (total 12 pcs.)	→ 0 70
[pos 20]	Screw forceps	80 mm	tk38399-08	1x	→ 0 63
[pos 21]	Washer for cancellous bone screws, 6.5 mm Ø	13 mm Ø	tk38415-13	6x	→ 0 74

Schrauben-Sets
Screw sets

Jeu des vis
Juego de tornillos
Set di viti

STAINLESS STEEL

TITANK



Bei Bestellung des Sets mit Schrauben in Titan, bitte der Artikelnummer ein „T“ hinzufügen
For the set with screws in titanium, please add a "T" to the reference number

Pour le jeu avec des vis en titane, veuillez ajouter un «T» à la référence

Para el juego con tornillos en titano, por favor añadiz un "T" a la referencia

Per il set con viti in titanio, per favore aggiuntete al numero d'articolo un "T"

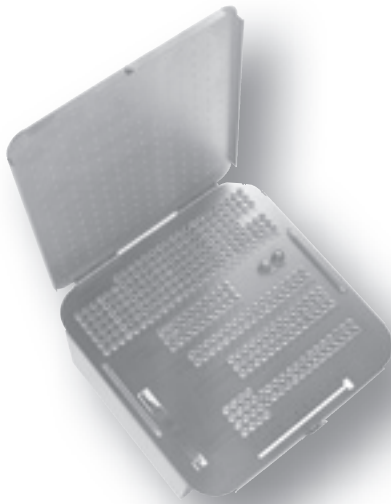

tk38444-60

Dieser Satz beinhaltet Instrumente der Pos. 01-16, siehe Seite 69

This set contents the instruments acc. to pos. 01-16, see page 69

Ce jeu contient instruments des positions 01-16, voir page 69

Este juego contiene los instrumentos de las posiciones 01-16, veasé pagina 69

Questo set contiene gli strumenti delle pos. 01-16, vedi pagina 69

Schrauben-Sets
Screw setsJeu des vis
Juego de tornillos
Set di viti

STAINLESS STEEL

[pos 01]	<i>Container</i>	285 x 280 x 135 mm	tk87110-1F-SI	1 x	→ 0 174
[pos 02]	<i>Tray (aluminium)</i>	245 x 245 x 120 mm	tk87070-06	1 x	
[pos 03]	<i>Cortical screw 4.5 mm Ø</i> 14 / 16 / 18 / 20 / 22 / 24 mm		tk38410-14 → -24	6 x each (total 36 pcs.)	→ 0 71
[pos 04]	<i>Cortical screws 4.5 mm Ø</i> 26 / 28 mm		tk38410-26 → -28	7 x each (total 14 pcs.)	→ 0 71
[pos 05]	<i>Cortical screw 4.5 mm Ø</i> 30 / 32 / 34 / 36 mm		tk38410-30 → -36	14 x each (total 56 pcs.)	→ 0 71
[pos 06]	<i>Cortical screws 4.5 mm Ø</i> 38 mm		tk38410-38	7 x	→ 0 71
[pos 07]	<i>Cortical screws 4.5 mm Ø</i> 40 mm		tk38410-40	14 x	→ 0 71
[pos 08]	<i>Cortical screw 4.5 mm Ø</i> 42 / 44 / 46 mm		tk38410-42 → -46	6 x each (total 18 pcs.)	→ 0 71
[pos 09]	<i>Cortical screws 4.5 mm Ø</i> 48 / 52 / 56 / 60 / 65 / 70 mm		tk38410-48 → -70	3 x each (total 18 pcs.)	→ 0 71
[pos 10]	<i>Malleolar screws 4.5 mm Ø</i> 25 / 30 / 35 / 40 / 45 / 50 / 55 / 60 / 65 / 70 mm		tk38412-25 → -70	3 x each (total 30 pcs.)	→ 0 73
[pos 11]	<i>Cancellous bone screws, 16 mm thread, 6.5 mm Ø</i> 30 / 35 / 40 / 45 / 50 / 55 / 60 / 65 / 70 / 75 / 80 / 85 / 90 / 95 / 100 / 105 / 110 mm		tk38414-30 → -10	2 x each (total 34 pcs.)	→ 0 70
[pos 12]	<i>Cancellous bone screws, 32 mm thread, 6.5 mm Ø</i> 45 / 50 / 55 / 60 / 65 / 70 / 75 / 80 / 85 / 90 / 95 / 100 / 105 / 110 mm		tk38416-45 → -10	3 x each (total 42 pcs.)	→ 0 70
[pos 13]	<i>Cancellous bone screw, full thread, 6.5 mm Ø</i> 25 / 30 / 35 / 40 mm		tk38418-25 → -40	4 x each (total 16 pcs.)	→ 0 70
[pos 14]	<i>Cancellous bone screw, full thread, 6.5 mm Ø</i> 45 / 50 / 55 / 60 / 65 / 70 / 75 / 80 / 85 / 90 / 95 / 100 / 105 / 110 mm		tk38418-45 → -10	2 x each (total 28 pcs.)	→ 0 70
[pos 15]	<i>Screw forceps</i>	80 mm	tk38399-08	1 x	→ 0 63
[pos 16]	<i>Washer for cancellous bone screws, 6.5 mm Ø</i>	13 mm Ø	tk38415-13	6 x	→ 0 74

Große Knochenschrauben
Large bone screws

Grandes vis osseuses
Tornillos grandes para huesos
Viti grandi per ossa

STAINLESS STEEL

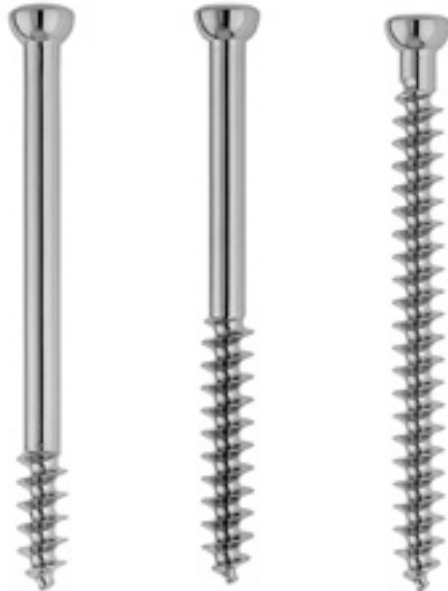

TITAN TK



Bei Bestellung von Titan Schrauben, bitte der Artikelnummer ein „T“ hinzufügen.

For titanium screws, please add a "T" to the reference number.

Pour des vis en titane, veuillez ajouter un «T» à la référence.

Para tornillos de titanio, por favor añadir un "T" a la referencia.

Per viti in titanio, per favore aggiungete al numero d'articolo un "T".

	a = 6.5 mm Ø	a = 6.5 mm Ø	a = 6.5 mm Ø
	b = 3.0 mm Ø	b = 3.0 mm Ø	b = 3.0 mm Ø
	c = 8.0 mm Ø	c = 8.0 mm Ø	c = 8.0 mm Ø
	e = 4.5 mm Ø	e = 4.5 mm Ø	
25 mm - 1 "	tk 384 14-25		tk 384 18-25
30 mm - 1¼ "	tk 384 14-30	tk 384 16-30	tk 384 18-30
35 mm - 1½ "	tk 384 14-35	tk 384 16-35	tk 384 18-35
40 mm - 1½ "	tk 384 14-40	tk 384 16-40	tk 384 18-40
45 mm - 1¾ "	tk 384 14-45	tk 384 16-45	tk 384 18-45
50 mm - 2 "	tk 384 14-50	tk 384 16-50	tk 384 18-50
55 mm - 2¼ "	tk 384 14-55	tk 384 16-55	tk 384 18-55
60 mm - 2½ "	tk 384 14-60	tk 384 16-60	tk 384 18-60
65 mm - 2½ "	tk 384 14-65	tk 384 16-65	tk 384 18-65
70 mm - 2¾ "	tk 384 14-70	tk 384 16-70	tk 384 18-70
75 mm - 3 "	tk 384 14-75	tk 384 16-75	tk 384 18-75
80 mm - 3¼ "	tk 384 14-80	tk 384 16-80	tk 384 18-80
85 mm - 3¼ "	tk 384 14-85	tk 384 16-85	tk 384 18-85
90 mm - 3½ "	tk 384 14-90	tk 384 16-90	tk 384 18-90
95 mm - 3¾ "	tk 384 14-95	tk 384 16-95	tk 384 18-95
100 mm - 4 "	tk 384 14-00	tk 384 16-00	tk 384 18-00
105 mm - 4¼ "	tk 384 14-05	tk 384 16-05	tk 384 18-05
110 mm - 4¼ "	tk 384 14-10	tk 384 16-10	tk 384 18-10
115 mm - 4½ "	tk 384 14-15	tk 384 16-15	tk 384 18-15
120 mm - 4¾ "	tk 384 14-20	tk 384 16-20	tk 384 18-20

Spongiosa <i>Cancellous</i>	Gewinde 16 mm <i>Thread 16 mm</i>	Gewinde 32 mm <i>Thread 32 mm</i>	Vollgewinde <i>Full thread</i>
Spongiosa <i>Spongiosa</i>	Filetage 16 mm <i>Rosca 16 mm</i>	Filetage 32 mm <i>Rosca 32 mm</i>	Filetage complet <i>Rosca completo</i>
Spongiosa	Filetto 16 mm	Filetto 32 mm	Filetto completo

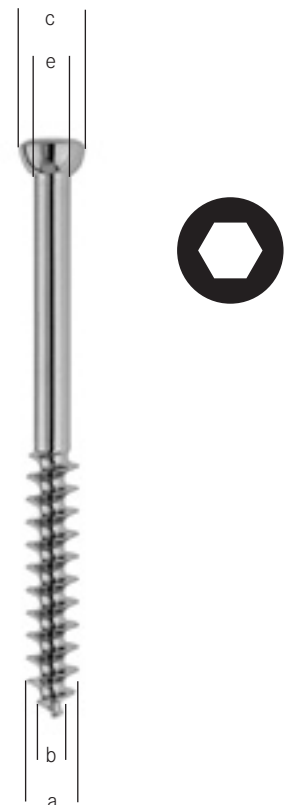

Große Knochenschrauben
Large bone screws

Grandes vis osseuses
Tornillos grandes para huesos
Viti grandi per ossa

STAINLESS STEEL

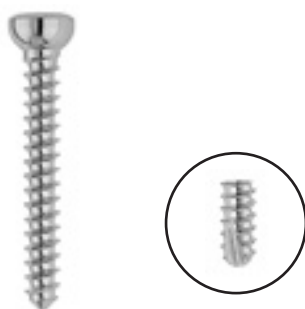

	a = 4.5 mm Ø	a = 4.5 mm Ø
	b = 3.0 mm Ø	b = 3.0 mm Ø
	c = 8.0 mm Ø	c = 8.0 mm Ø
14 mm - 1/2 "	tk 384 10-14	tk 38430-14
16 mm - 3/4 "	tk 384 10-16	tk 38430-16
18 mm - 3/4 "	tk 384 10-18	tk 38430-18
20 mm - 3/4 "	tk 384 10-20	tk 38430-20
22 mm - 3/4 "	tk 384 10-22	tk 38430-22
24 mm - 1 "	tk 384 10-24	tk 38430-24
26 mm - 1 "	tk 384 10-26	tk 38430-26
28 mm - 1 "	tk 384 10-28	tk 38430-28
30 mm - 1 1/4 "	tk 384 10-30	tk 38430-30
32 mm - 1 1/4 "	tk 384 10-32	tk 38430-32
34 mm - 1 1/4 "	tk 384 10-34	tk 38430-34
36 mm - 1 1/2 "	tk 384 10-36	tk 38430-36
38 mm - 1 1/2 "	tk 384 10-38	tk 38430-38
40 mm - 1 1/2 "	tk 384 10-40	tk 38430-40
42 mm - 1 3/4 "	tk 384 10-42	tk 38430-42
44 mm - 1 3/4 "	tk 384 10-44	tk 38430-44
46 mm - 1 3/4 "	tk 384 10-46	tk 38430-46
48 mm - 2 "	tk 384 10-48	tk 38430-48
50 mm - 2 "	tk 384 10-50	tk 38430-50
52 mm - 2 "	tk 384 10-52	tk 38430-52
54 mm - 2 1/4 "	tk 384 10-54	tk 38430-54
56 mm - 2 1/4 "	tk 384 10-56	tk 38430-56
58 mm - 2 1/4 "	tk 384 10-58	tk 38430-58
60 mm - 2 1/4 "	tk 384 10-60	tk 38430-60
65 mm - 2 1/2 "	tk 384 10-65	tk 38430-65
70 mm - 2 3/4 "	tk 384 10-70	tk 38430-70
75 mm - 3 "	tk 384 10-75	tk 38430-75
80 mm - 3 1/4 "	tk 384 10-80	tk 38430-80
85 mm - 3 1/4 "	tk 384 10-85	tk 38430-85
90 mm - 3 1/2 "	tk 384 10-90	tk 38430-90
95 mm - 3 3/4 "	tk 384 10-95	tk 38430-95
100 mm - 4 "	tk 384 10-00	tk 38430-00
105 mm - 4 1/4 "	tk 384 10-01	tk 38430-01
110 mm - 4 1/4 "	tk 384 10-02	tk 38430-02
115 mm - 4 1/2 "	tk 384 10-03	tk 38430-03
120 mm - 4 3/4 "	tk 384 10-04	tk 38430-04

Kortikalis	Standard	Selbstschneidend
<i>Cortical</i>	<i>Standard</i>	<i>Self-cutting</i>
Corticalis	Standard	Auto coupante
<i>Corticalis</i>	<i>Estandar</i>	<i>Auto cortante</i>
Corticali	Standard	Autofilettante

TITANK



Bei Bestellung von Titan Schrauben, bitte der Artikelnummer ein „T“ hinzufügen.

For titanium screws, please add a "T" to the reference number.

Pour des vis en titane, veuillez ajouter un «T» à la référence.

Para tornillos de titanio, por favor añadir und "T" a la referencia.

Per viti in titanio, per favore aggiungete al numero d'articolo un "T".



Große Knochenschrauben
Large bone screws

Grandes vis osseuses
Tornillos grandes para huesos
Viti grandi per ossa

STAINLESS STEEL

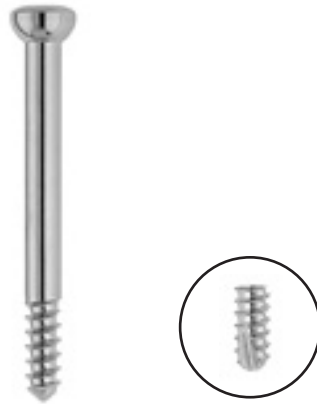

	a = 4.5 mm Ø	a = 4.5 mm Ø
	b = 3.1 mm Ø	b = 3.1 mm Ø
	c = 8.0 mm Ø	c = 8.0 mm Ø
	e = 4.5 mm Ø	e = 4.5 mm Ø
22 mm - ¾"	tk 38428-22	tk 38429-22
24 mm - 1"	tk 38428-24	tk 38429-24
26 mm - 1"	tk 38428-26	tk 38429-26
28 mm - 1"	tk 38428-28	tk 38429-28
30 mm - 1¼"	tk 38428-30	tk 38429-30
32 mm - 1¼"	tk 38428-32	tk 38429-32
34 mm - 1¼"	tk 38428-34	tk 38429-34
36 mm - 1½"	tk 38428-36	tk 38429-36
38 mm - 1½"	tk 38428-38	tk 38429-38
40 mm - 1½"	tk 38428-40	tk 38429-40
42 mm - 1¾"	tk 38428-42	tk 38429-42
44 mm - 1¾"	tk 38428-44	tk 38429-44
46 mm - 1¾"	tk 38428-46	tk 38429-46
48 mm - 2"	tk 38428-48	tk 38429-48
50 mm - 2"	tk 38428-50	tk 38429-50
52 mm - 2"	tk 38428-52	tk 38429-52
54 mm - 2¼"	tk 38428-54	tk 38429-54
56 mm - 2¼"	tk 38428-56	tk 38429-56
58 mm - 2¼"	tk 38428-58	tk 38429-58
60 mm - 2¼"	tk 38428-60	tk 38429-60
65 mm - 2½"	tk 38428-65	tk 38429-65
70 mm - 2¾"	tk 38428-70	tk 38429-70
75 mm - 3"	tk 38428-75	tk 38429-75
80 mm - 3¼"	tk 38428-80	tk 38429-80
85 mm - 3¼"	tk 38428-85	tk 38429-85
90 mm - 3½"	tk 38428-90	tk 38429-90
95 mm - 3¾"	tk 38428-95	tk 38429-95
100 mm - 4"	tk 38428-00	tk 38429-00
105 mm - 4¼"	tk 38428-05	tk 38429-05
110 mm - 4¼"	tk 38428-10	tk 38429-10

Schaft <i>Shank</i>	Standard <i>Standard</i>	Selbstschneidend <i>Self-cutting</i>
Tige <i>Tija</i>	Standard <i>Estandar</i>	Auto coupante <i>Auto cortante</i>
Asta	Standard	Autofiletante

TITAN TK



Bei Bestellung von Titan Schrauben, bitte der Artikelnummer ein „T“ hinzufügen.

For titanium screws, please add a "T" to the reference number.

Pour des vis en titane, veuillez ajouter un «T» à la référence.

Para tornillos de titanio, por favor añadir un "T" a la referencia.

Per viti in titanio, per favore aggiungete al numero d'articolo un "T".

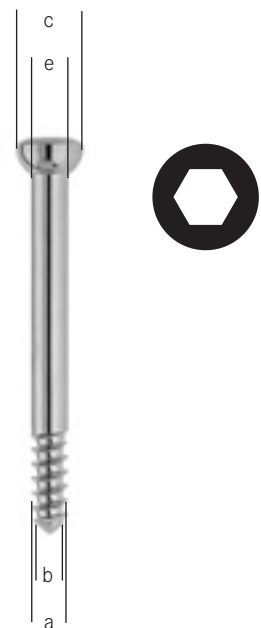

Große Knochenschrauben
Large bone screws

Grandes vis osseuses
Tornillos grandes para huesos
Viti grandi per ossa

STAINLESS STEEL



a = 4.5 mm Ø
b = 3.0 mm Ø
c = 8.0 mm Ø
e = 3.0 mm Ø

20 mm - ¾"	tk 384 12-20
25 mm - 1"	tk 384 12-25
30 mm - 1¼"	tk 384 12-30
35 mm - 1¼"	tk 384 12-35
40 mm - 1½"	tk 384 12-40
45 mm - 1¾"	tk 384 12-45
50 mm - 2"	tk 384 12-50
55 mm - 2¼"	tk 384 12-55
60 mm - 2¼"	tk 384 12-60
65 mm - 2½"	tk 384 12-65
70 mm - 2¾"	tk 384 12-70
75 mm - 3"	tk 384 12-75
80 mm - 3¼"	tk 384 12-80

Malleolar	Standard
<i>Malleolar</i>	<i>Standard</i>
Maléolar	Standard
<i>Maleolar</i>	<i>Estandar</i>
Maleolari	Standard



Unterlegscheiben
Washers

Rondelles
Arandelas
Rondelle



11.0 mm Ø	13.0 mm Ø	13.0 mm Ø	13.0 mm Ø
tk 38415-11	tk 38415-13	tk 38415-14	tk 38415-15
für 4,5 mm und 6,5 mm Schrauben <i>for 4.5 mm and 6.5 mm screws</i>	mit 4 Spitzen <i>with 4 spikes</i>	mit 10 Spitzen <i>with 10 spikes</i>	
pour vis 4.5 mm et 6.5 mm <i>para tornillos 4.5 mm y 6.5 mm</i>	avec 4 crochets <i>con 4 ganchos</i>	avec 10 crochets <i>con 10 ganchos</i>	
per viti 4.5 mm e 6.5 mm	con 4 punte	con 10 punte	



Bei Bestellung von Titan Unterlagsscheiben, bitte der Artikelnummer ein „T“ hinzufügen.

For titanium washers, please add a "T" to the reference number.

Pour des rondelles en titane, veuillez ajouter un «T» à la référence.

Para arandelas de titanio, por favor añadir und "T" a la referencia.

Per rondelle in titanio, per favore aggiuntete al numero d'articolo un "T".



SW 8 mm

tk 38417-08

Mutter für 4,5 mm Kortikalis Schrauben
Nut for 4.5 mm cortical screws

Écroux pour vis corticalis de 4.5 mm

Tuerca para tornillos corticalis de 4.5 mm

Dado per viti corticali di 4.5 mm

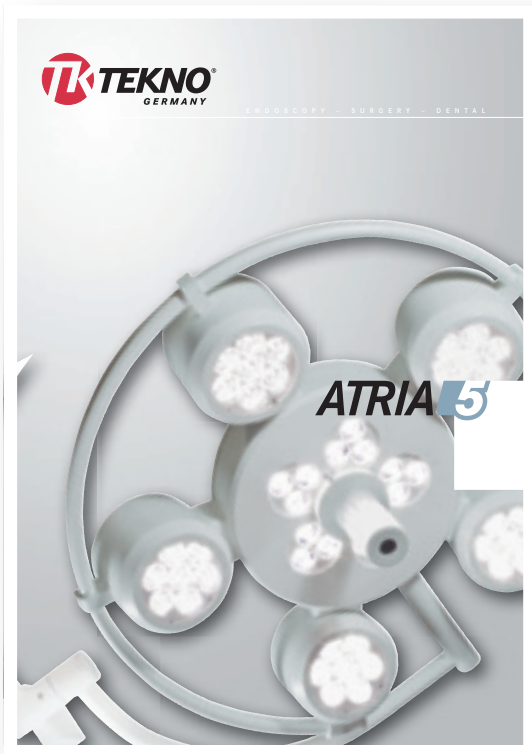

Bitte fordern Sie unseren Spezialkatalog an.
Please ask for our special catalogue.

Veuillez demander pour notre catalogue spécial.
Por favor preguntan para el catálogo especial.

Per favore domandate per il nostro catalogo speciale.

Platten-Set
Plates set

Jeu des plaques
Juego de placas
Set di placche

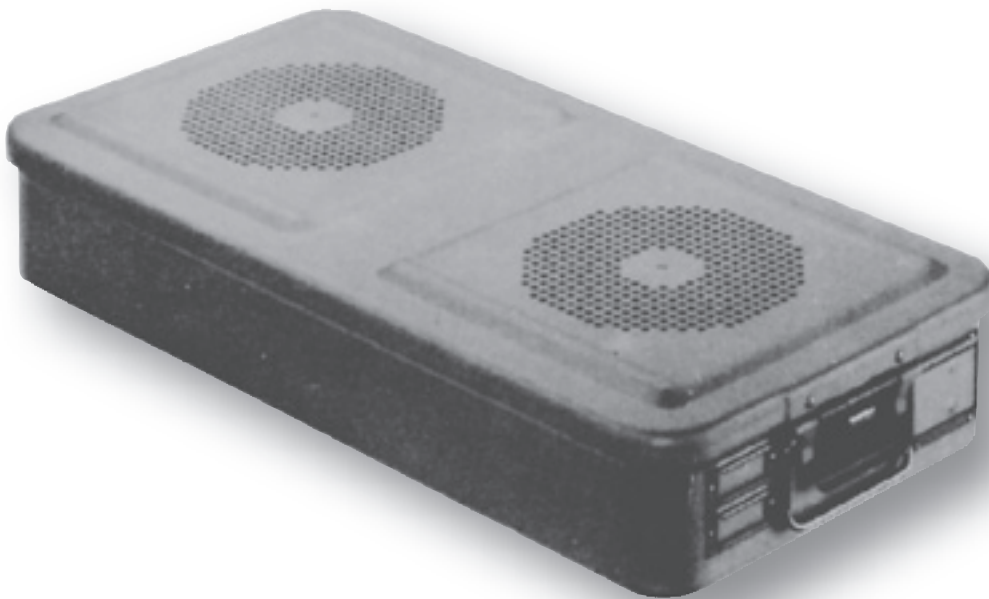
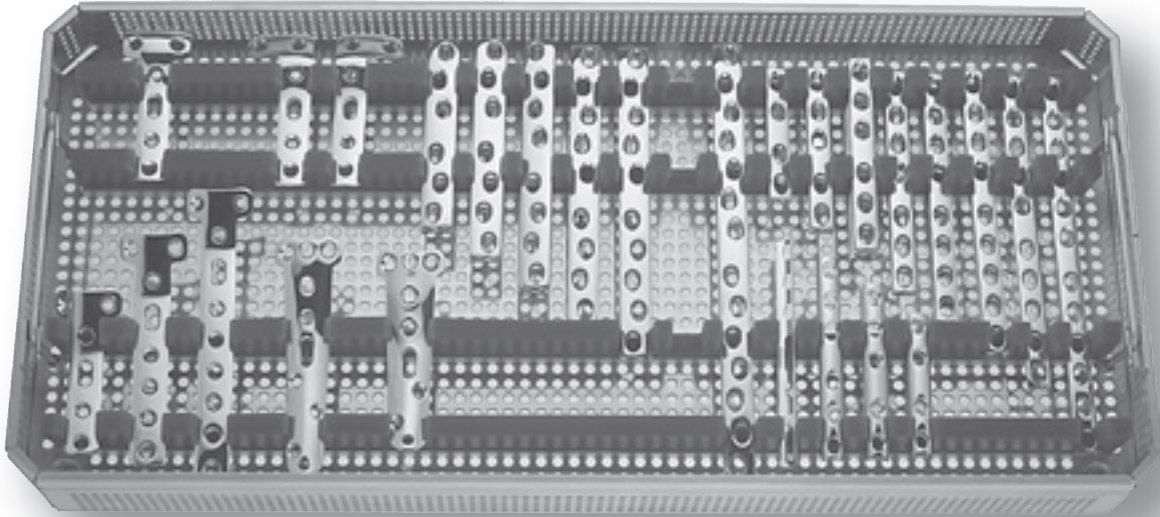

tk 38443-30

Dieser Satz beinhaltet Instrumente der Pos. 01-30, siehe Seite 77
This set contents the instruments acc. to pos. 01-30, see page 77

Ce jeu contient instruments des positions 01-30, voir page 77

Este juego contiene los instrumentos de las posiciones 01-30, veasé pagina 77

Questo set contiene gli strumenti delle pos. 01-30, vedi pagina 77

Platten-Set
Plates set

Jeu des plaques
Juego de placas
Set di placche

[pos 01]	<i>Container</i>	580 x 280 x 100 mm	tk 87170-1F-SI	1 x	→ 0 173
[pos 02]	<i>Tray</i>		tk 87050-56	1 x	
[pos 03]	<i>Semi-Tubular plate, 4 holes</i>	71 mm - 2 ¾ "	tk 38359-04	2x	→ 0 80
[pos 04]	<i>Semi-Tubular plate, 5 holes</i>	87 mm - 3 ½ "	tk 38359-05	2x	→ 0 80
[pos 05]	<i>Semi-Tubular plate, 6 holes</i>	103 mm - 4 "	tk 38359-06	2x	→ 0 80
[pos 06]	<i>Semi-Tubular plate, 7 holes</i>	119 mm - 4 ¾ "	tk 38359-07	1 x	→ 0 80
[pos 07]	<i>Compression plates, 4 holes, narrow</i>	71 mm - 2 ¾ "	tk 38336-04	2 x	→ 0 79
[pos 09]	<i>Compression plates, 5 holes, narrow</i>	87 mm - 3 ½ "	tk 38336-05	2 x	→ 0 79
[pos 10]	<i>Compression plates, 6 holes, narrow</i>	103 mm - 4 "	tk 38336-06	4 x	→ 0 79
[pos 11]	<i>Compression plates, 7 holes, narrow</i>	119 mm - 4 ¾ "	tk 38336-07	2 x	→ 0 79
[pos 12]	<i>Compression plates, 8 holes, narrow</i>	135 mm - 5 ¼ "	tk 38336-08	2 x	→ 0 79
[pos 13]	<i>Compression plates, 9 holes, narrow</i>	151 mm - 6 "	tk 38336-09	2 x	→ 0 79
[pos 14]	<i>Compression plates, 10 holes, narrow</i>	167 mm - 6 ½ "	tk 38336-10	1 x	→ 0 79
[pos 15]	<i>Compression plates, 12 holes, narrow</i>	199 mm - 7 ¾ "	tk 38336-12	1 x	→ 0 79
[pos 16]	<i>Compression plates, 6 holes, broad</i>	103 mm - 4 "	tk 38335-06	2 x	→ 0 79
[pos 17]	<i>Compression plates, 7 holes, broad</i>	119 mm - 4 ¾ "	tk 38335-07	2 x	→ 0 79
[pos 18]	<i>Compression plates, 8 holes, broad</i>	135 mm - 5 ¼ "	tk 38335-08	2 x	→ 0 79
[pos 19]	<i>Compression plates, 9 holes, broad</i>	151 mm - 6 "	tk 38335-09	1 x	→ 0 79
[pos 20]	<i>Compression plates, 10 holes, broad</i>	167 mm - 6 ½ "	tk 38335-10	1 x	→ 0 79
[pos 21]	<i>Compression plates, 12 holes, broad</i>	199 mm - 7 ¾ "	tk 38335-12	1 x	→ 0 79
[pos 22]	<i>Compression plates, 14 holes, broad</i>	231 mm - 9 "	tk 38335-14	1 x	→ 0 79
[pos 23]	<i>Spoon plates, 5 holes</i>	100 mm - 4 "	tk 38380-15	1 x	→ 0 83
[pos 24]	<i>Spoon plates, 6 holes</i>	120 mm - 4 ¾ "	tk 38380-16	1 x	→ 0 83
[pos 25]	<i>T-Plate, 4 holes</i>	84 mm - 3 ¼ "	tk 38361-04	1 x	→ 0 81
[pos 26]	<i>T-Plate, 6 holes</i>	116 mm - 4 ½ "	tk 38361-06	1 x	→ 0 81
[pos 27]	<i>T-Plate, 8 holes</i>	148 mm - 5 ¾ "	tk 38361-08	1 x	→ 0 81
[pos 28]	<i>T-Bone plate, 4 holes</i>	81 mm - 3 ¼ "	tk 38362-04	1 x	→ 0 81
[pos 29]	<i>L-Plate, 4 holes, left</i>	85 mm - 3 ¼ "	tk 38363-04	1 x	→ 0 82
[pos 30]	<i>L-Plate, 4 holes, right</i>	85 mm - 3 ¼ "	tk 38364-04	1 x	→ 0 82

MTCP-Platten
MTCP-Plates
Plaques MTCP
Placas MTCP
Placche MTCP
STAINLESS STEEL

Für Schrauben mit Ø 4,5 mm und 6,5 mm
For screws with Ø 4.5 mm and 6.5 mm
Pour vis avec Ø 4.5 mm et 6.5 mm
Para tornillos con Ø 4.5 mm y 6.5 mm
Per viti Ø 4.5 mm e 6.5 mm

**Bei Bestellung von Titan
Knochenplatten, bitte der
Artikelnummer ein „T“
hinzufügen.**
**For titanium bone plate, please
add a "T" to the reference
number.**
**Pour des plaques osseuses en
titane, veuillez ajouter un «T» à
la référence.**
**Para placas de titanio, por favor
añadir und "T" a la referencia.**
**Per placche in titanio, per favore
aggiuntete al numero d'articolo
un "T".**

T
a
L

		a = 13.5 mm	a = 17.5 mm
		b = 4.4 mm	b = 5.2 mm
34 mm - 1½"	2	tk 38343-02	-
52 mm - 2"	3	tk 38343-03	-
70 mm - 2¾"	4	tk 38343-04	-
88 mm - 3½"	5	tk 38343-05	-
106 mm - 4¼"	6	tk 38343-06	tk 38344-06
124 mm - 5"	7	tk 38343-07	tk 38344-07
142 mm - 5½"	8	tk 38343-08	tk 38344-08
160 mm - 6½"	9	tk 38343-09	tk 38344-09
178 mm - 7"	10	tk 38343-10	tk 38344-10
196 mm - 7¾"	11	tk 38343-11	tk 38344-11
214 mm - 8½"	12	tk 38343-12	tk 38344-12
232 mm - 9"	13	-	tk 38344-13
250 mm - 9¾"	14	tk 38343-14	tk 38344-14
268 mm - 10½"	15	-	tk 38344-15
286 mm - 11¼"	16	tk 38343-16	tk 38344-16
304 mm - 12"	17	-	tk 38344-17
322 mm - 12¾"	18	-	tk 38344-18

Löcher	Schmal	Breit
Holes	Narrow	Broad
Trous	Étroit	Largeur
Orificios	Estrecho	Anchura
Fori	Stretto	Largo

Kompressionslatten
Compression plates

Plaques de compression
Placas de compresión
Placche per ossa a compressione

STAINLESS STEEL



Für Schrauben:

Ø 4,5 mm - Kortikalis , Malleolar

Ø 6,5 mm - Spongiosa

For screws:

Ø 4.5 mm - Cortical, Malleolar

Ø 6.5 mm - Cancellous

Pour vis:

Ø 4.5 mm - Corticalis, Maléolar,

Ø 6.5 mm - Spongiosa

Para tornillos:

Ø 4.5 mm - Corticalis, Maleolar

Ø 6.5 mm - Spongiosa

Per viti:

Ø 4.5 mm - Corticali, Maleolari

Ø 6.5 mm - Spongiosa



		a = 12.0 mm
		b = 3.8 mm
39 mm - 1 1/2 "	2	tk 38336-02
55 mm - 2 1/4 "	3	tk 38336-03
71 mm - 2 3/4 "	4	tk 38336-04
87 mm - 3 1/2 "	5	tk 38336-05
103 mm - 4 "	6	tk 38336-06
119 mm - 4 3/4 "	7	tk 38336-07
135 mm - 5 1/4 "	8	tk 38336-08
151 mm - 6 "	9	tk 38336-09
167 mm - 6 1/2 "	10	tk 38336-10
183 mm - 7 1/4 "	11	tk 38336-11
199 mm - 7 3/4 "	12	tk 38336-12
215 mm - 8 1/2 "	13	tk 38336-13
231 mm - 9 "	14	tk 38336-14
247 mm - 9 3/4 "	15	tk 38336-15
263 mm - 10 1/4 "	16	tk 38336-16

schmal Löcher
narrow *Holes*
étroit Trous
estrecho *Orificios*
stretto Fori



		a = 16.0 mm
		b = 4.8 mm
103 mm - 4 "	6	tk 38335-02
119 mm - 4 3/4 "	7	tk 38335-03
135 mm - 5 1/4 "	8	tk 38335-04
151 mm - 6 "	9	tk 38335-05
167 mm - 6 1/2 "	10	tk 38335-06
183 mm - 7 1/4 "	11	tk 38335-07
199 mm - 7 3/4 "	12	tk 38335-08
215 mm - 8 1/2 "	13	tk 38335-09
231 mm - 9 "	14	tk 38335-10
247 mm - 9 3/4 "	15	tk 38335-11
263 mm - 10 1/4 "	16	tk 38335-12
279 mm - 11 "	17	tk 38335-13
295 mm - 11 1/2 "	18	tk 38335-14

breit Löcher
large *Holes*
largeur Trous
anchura *Orificios*
largo Fori

Knochenplatten
Bone plates

Plaques osseuses
Placas para huesos
Placche per ossa

STAINLESS STEEL



Für Schrauben mit Ø 4,5 mm
For screws with Ø 4.5 mm
Pour vis avec Ø 4.5 mm
Para tornillos con Ø 4.5 mm
Per viti Ø 4.5 mm

Halbrohrplatten
Semi-tubular plates

Plaques tubulaire de demi tubulaire
Placas semi tubulares
Semi tubular placche



Bei Bestellung von Titan Knochenplatten, bitte der Artikelnummer ein „T“ hinzufügen.

For titanium bone plate, please add a "T" to the reference number.

Pour des plaques osseuses en titane, veuillez ajouter un «T» à la référence.

Para placas de titanio, por favor añadir un "T" a la referencia.

Per placche in titanio, per favore aggiuntete al numero d'articolo un "T".

a = 12.0 mm
b = 1.0 mm
c = 5.8 mm Ø

39 mm - 1 ½ "	2	tk 38359-02
55 mm - 2 ¼ "	3	tk 38359-03
71 mm - 2¾ "	4	tk 38359-04
87 mm - 3½ "	5	tk 38359-05
103 mm - 4 "	6	tk 38359-06
119 mm - 4¾ "	7	tk 38359-07
135 mm - 5¼ "	8	tk 38359-08
151 mm - 6 "	9	tk 38359-09
167 mm - 6½ "	10	tk 38359-10
183 mm - 7¼ "	11	tk 38359-11
199 mm - 7¾ "	12	tk 38359-12

Löcher
Holes
Trous
Orificios
Fori

Tibia Knochenplatten
Tibia bone plates

Plaques pour jambes
Placas para planos
Placche per ossa tibiali

STAINLESS STEEL



Für Schrauben mit Ø 4,5 mm
For screws with Ø 4.5 mm
Pour vis avec Ø 4.5 mm
Para tornillos con Ø 4.5 mm
Per viti Ø 4.5 mm



Bei Bestellung von Titan Knochenplatten, bitte der Artikelnummer ein „T“ hinzufügen.

For titanium bone plate, please add a "T" to the reference number.

Pour des plaques osseuses en titane, veuillez ajouter un «T» à la référence.

Para placas de titanio, por favor añadir un "T" a la referencia.

Per placche in titanio, per favore aggiuntete al numero d'articolo un "T".



68 mm - 2¾"	3	tk 38361-03
84 mm - 3¼"	4	tk 38361-04
100 mm - 4"	5	tk 38361-05
116 mm - 4½"	6	tk 38361-06
148 mm - 5¾"	8	tk 38361-08

T-Platten **Löcher**
T-plates *Holes*
Plaques en T Trous
Placas en T *Orificios*
Placche forma T Fori

80 mm - 3¼"	4	tk 38362-04
103 mm - 4"	5	tk 38362-05
116 mm - 4½"	6	tk 38362-06

T-Platten **Löcher**
T-plates *Holes*
Plaques en T Trous
Placas en T *Orificios*
Placche forma T Fori

Tibia Knochenplatten
Tibia bone plates

Plaques pour jambes
Placas para planos
Placche per ossa tibiali

STAINLESS STEEL



Für Kortikalis Schrauben mit Ø 4,5 mm
For cortical screws with Ø 4.5 mm
Pour vis corticales avec Ø 4.5 mm
Para tornillos corticalis con Ø 4.5 mm
Per viti corticali con 4.5 mm

TITANTK



Bei Bestellung von Titan Knochenplatten, bitte der Artikelnummer ein „T“ hinzufügen.

For titanium bone plate, please add a "T" to the reference number.

Pour des plaques osseuses en titane, veuillez ajouter un «T» à la référence.

Para placas de titanio, por favor añadir un "T" a la referencia.

Per placche in titanio, per favore aggiuntete al numero d'articolo un "T".



84 mm - 3¼"	4	tk 38363-04	tk 38364-04
166 mm - 6½"	6	tk 38363-06	tk 38364-06
148 mm - 5¾"	8	tk 38363-08	tk 38364-08

L-Abstützplatten Löcher
L-Buttress plates Holes
Plaques en L Trous
Placas en L Orificios
Placche forma L Fori

Links
Left
Gauche
Izquierda
Sinistra

Rechts
Right
Droit
Derecha
Destra

Tibia Knochenplatten
Tibia bone plates

Plaques pour jambes
Placas para planos
Placche per ossa tibiali

STAINLESS STEEL

> Für Schrauben mit Ø 4,5 mm
For screws with Ø 4.5 mm
Pour vis avec Ø 4.5 mm
Para tornillos con Ø 4.5 mm
Per viti Ø 4.5 mm

TITAN^{TK}

> Bei Bestellung von Titan Knochenplatten, bitte der Artikelnummer ein „T“ hinzufügen.

For titanium bone plate, please add a "T" to the reference number.

Pour des plaques osseuses en titane, veuillez ajouter un «T» à la référence.

Para placas de titanio, por favor añadir un "T" a la referencia.

Per placche in titanio, per favore aggiungete al numero d'articolo un "T".



100 mm - 4 "	5	tk 38380-15
120 mm - 4¾ "	6	tk 38380-16

Löffelplatten	Löcher
<i>Spoon-plates</i>	<i>Holes</i>
Plaques cuillères	Trous
<i>Placas cucharas</i>	<i>Orificios</i>
Placche a cucchiaio	Fori

Verlängerte Kompressionslatten
Extended compression plates

 Plagues de compression allongées
 Placas de compresión alargadas
 Placche a compresione prolungate

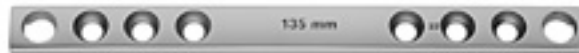
STAINLESS STEEL

135 mm - 5¼"	30 mm	8	tk 38336-30
145 mm - 5¾"	40 mm		tk 38336-40
155 mm - 6"	50 mm		tk 38336-50
165 mm - 6½"	60 mm		tk 38336-60
175 mm - 7"	70 mm		tk 38336-70
185 mm - 7"	80 mm		tk 38336-80

schmal	Verlängerung	Löcher
<i>narrow</i>	<i>Extension</i>	<i>Holes</i>
étroit	Prolongation	Trous
<i>estrecho</i>	<i>Alargamiento</i>	<i>Orificios</i>
stretto	Prolungamento	Fori



135 mm - 5¼"	30 mm	8	tk 38335-30
145 mm - 5¾"	40 mm		tk 38335-40
155 mm - 6"	50 mm		tk 38335-50
165 mm - 6½"	60 mm		tk 38335-60

breit	Verlängerung	Löcher
<i>broad</i>	<i>Extension</i>	<i>Holes</i>
large	Prolongation	Trous
<i>anchura</i>	<i>Alargamiento</i>	<i>Orificios</i>
largo	Prolungamento	Fori



179 mm - 7"	50 mm	10	tk 38335-72
189 mm - 7½"	60 mm		tk 38335-74
199 mm - 7¾"	70 mm		tk 38335-76
209 mm - 8¼"	80 mm		tk 38335-78
219 mm - 8½"	90 mm		tk 38335-79
229 mm - 9"	100 mm		tk 38335-80
239 mm - 9½"	110 mm		tk 38335-82
249 mm - 9¾"	120 mm		tk 38335-84

breit	Verlängerung	Löcher
<i>broad</i>	<i>Extension</i>	<i>Holes</i>
large	Prolongation	Trous
<i>anchura</i>	<i>Alargamiento</i>	<i>Orificios</i>
largo	Prolungamento	Fori

Anatomische Knochenplatten
Anatomical bone plates

Plaques osseuses anatomiques
Placas anatomicas para huesos
Placche anatomiche per ossa

STAINLESS STEEL

- >** Für Schrauben:
 Ø 4,5 mm - Kortikalis,
 Ø 6,5 mm - Spongiosa
For screws:
 Ø 4.5 mm - Cortical,
 Ø 6.5 mm - Cancellous
Pour vis:
 Ø 4.5 mm - Corticalis,
 Ø 6.5 mm - Spongiosa
Para tornillos:
 Ø 4.5 mm - Corticalis,
 Ø 6.5 mm - Spongiosa
Per viti:
 Ø 4.5 mm - Corticali
 Ø 6.5 mm - Spongiosa



x = 16 mm y = 22 mm	122 mm - 4¾"	7	tk 38365-07	tk 38366-07
	158 mm - 6¼"	9	tk 38365-09	tk 38366-09
	194 mm - 7¾"	11	tk 38365-11	tk 38366-11
	230 mm - 9"	13	tk 38365-13	tk 38366-13

Distale Tibia Platten <i>Distal tibia plates</i>	Löcher <i>Holes</i>	Links <i>Left</i>	Rechts <i>Right</i>
<i>Plaques tibia distales</i>	<i>Trous</i>	<i>Gauche</i>	<i>Droit</i>
<i>Placas distales para tibia</i>	<i>Orificios</i>	<i>Izquierda</i>	<i>Derecha</i>
<i>Placche distali per tibia</i>	<i>Fori</i>	<i>Sinistra</i>	<i>Destra</i>



> Bei Bestellung von Titan Knochenplatten, bitte der Artikelnummer ein „T“ hinzufügen.

For titanium bone plate, please add a "T" to the reference number.

Pour des plaques osseuses en titane, veuillez ajouter un «T» à la référence.

Para placas de titanio, por favor añadir un "T" a la referencia.

Per placche in titanio, per favore aggiuntete al numero d'articolo un "T".



x = 16 mm y = 22 mm	122 mm - 4¾"	7	tk 38367-07	tk 38368-07
	158 mm - 6¼"	9	tk 38367-09	tk 38368-09
	194 mm - 7¾"	11	tk 38367-11	tk 38368-11
	230 mm - 9"	13	tk 38367-13	tk 38368-13

Proximal Tibia Platten <i>Proximal tibia plates</i>	Löcher <i>Holes</i>	Links <i>Left</i>	Rechts <i>Right</i>
<i>Plaques tibia proximales</i>	<i>Trous</i>	<i>Gauche</i>	<i>Droit</i>
<i>Placas proximales para tibia</i>	<i>Orificios</i>	<i>Izquierda</i>	<i>Derecha</i>
<i>Placche prossimali per tibia</i>	<i>Fori</i>	<i>Sinistra</i>	<i>Destra</i>

Anatomische Knochenplatten
Anatomical bone plates

Plaques osseuses anatomiques
Placas anatomicas para huesos
Placche anatomiche per ossa

STAINLESS STEEL



Für Schrauben:
Ø 4,5 mm - Kortikalis,
Ø 6,5 mm - Spongiosa
For screws:
Ø 4.5 mm - Cortical,
Ø 6.5 mm - Cancellous
Pour vis:
Ø 4.5 mm - Corticalis,
Ø 6.5 mm - Spongiosa
Para tornillos:
Ø 4.5 mm - Corticalis,
Ø 6.5 mm - Spongiosa
Per viti:
Ø 4.5 mm - Corticali
Ø 6.5 mm - Spongiosa



Bei Bestellung von Titan Knochenplatten, bitte der Artikelnummer ein „T“ hinzufügen.

For titanium bone plate, please add a "T" to the reference number.

Pour des plaques osseuses en titane, veuillez ajouter un «T» à la référence.

Para placas de titanio, por favor añadir un "T" a la referencia.

Per placche in titanio, per favore aggiungete al numero d'articolo un "T".

x = 16 mm y = 22 mm	122 mm - 4¾"	7	tk 38370-07	tk 38371-07
	158 mm - 6¼"	9	tk 38370-09	tk 38371-09
	194 mm - 7¾"	11	tk 38370-11	tk 38371-11
	230 mm - 9"	13	tk 38370-13	tk 38371-13

Distale Femur Platten <i>Distal femur plates</i>	Löcher <i>Holes</i>	Links <i>Left</i>	Rechts <i>Right</i>
Plaques distales femur <i>Placas distales para femur</i> Placche distali per femore	Trous <i>Orificios</i> Fori	Gauche <i>Izquierda</i> Sinistra	Droit <i>Derecha</i> Destra



x = 16 mm y = 22 mm	122 mm - 4¾"	7	tk 38372-07	tk 38373-07
	158 mm - 6¼"	9	tk 38372-09	tk 38373-09
	194 mm - 7¾"	11	tk 38372-11	tk 38373-11
	230 mm - 9"	13	tk 38372-13	tk 38373-13

Distale Tibia Platten Fibula <i>Distal tibia plates fibula</i>	Löcher <i>Holes</i>	Links <i>Left</i>	Rechts <i>Right</i>
Plaques distales fibulae tibia <i>Placas distales para fibula tibia</i> Placche distali febulare per tibia	Trous <i>Orificios</i> Fori	Gauche <i>Izquierda</i> Sinistra	Droit <i>Derecha</i> Destra

Spezial Knochenplatten
Special bone plates

Plaques osseuses spéciales
Placas especiales para huesos
Placche speciali per ossa

STAINLESS STEEL

> Für Kortikalis Schrauben mit Ø 4,5 mm
For cortical screws with Ø 4.5 mm
Pour vis corticales avec Ø 4.5 mm
Para tornillos corticales con Ø 4.5 mm
Per viti corticali con Ø 4.5 mm



158 mm - 6¼"	7	tk 38381-07	tk 38382-07
190 mm - 7½"	9	tk 38381-09	tk 38382-09
221 mm - 8¾"	11	tk 38381-11	tk 38382-11
253 mm - 10"	13	tk 38381-13	tk 38382-13
285 mm - 11¼"	15	tk 38381-15	tk 38382-15

Distal Femur Lateral <i>Distal femur lateral</i>	Löcher <i>Holes</i>	Links <i>Left</i>	Rechts <i>Right</i>
Distal femur lateral <i>Distal femur lateral</i>	Trous <i>Orificios</i>	Gauche <i>Izquierda</i>	Droit <i>Derecha</i>
Femore distale laterale	Fori	Sinistra	Destra



> Bei Bestellung von Titan Knochenplatten, bitte der Artikelnummer ein „T“ hinzufügen.

For titanium bone plate, please add a "T" to the reference number.

Pour des plaques osseuses en titane, veuillez ajouter un «T» à la référence.

Para placas de titanio, por favor añadir un "T" a la referencia.

Per placche in titanio, per favore aggiuntete al numero d'articolo un "T".



	5	tk 38383-05	tk 38384-05
	7	tk 38383-07	tk 38384-07
	9	tk 38383-09	tk 38384-09
	11	tk 38383-11	tk 38384-11
	13	tk 38383-13	tk 38384-13

Tibia Proximal-Lateral (MTCP) <i>Tibia proximal-lateral (MTCP)</i>	Löcher <i>Holes</i>	Links <i>Left</i>	Rechts <i>Right</i>
Tibia proximal-lateral (MTCP) <i>Tibia proximal-lateral (MTCP)</i>	Trous <i>Orificios</i>	Gauche <i>Izquierda</i>	Droit <i>Derecha</i>
Tibia prossimale-laterale (MTCP)	Fori	Sinistra	Destra

Spezial Knochenplatten
Special bone plates

Plaques osseuses spéciales
Placas especiales para huesos
Placche speciali per ossa

STAINLESS STEEL



170 mm - 6¾"	8	tk 38379-08
186 mm - 7¼"	9	tk 38379-09
202 mm - 8"	10	tk 38379-10
218 mm - 8½"	11	tk 38379-11

Cobra Femoral	Löcher	Links und Rechts
<i>Cobra femoral</i>	<i>Holes</i>	<i>Left and right</i>
Cobra femural	Trous	Gauche et droite
<i>Cobra femural</i>	<i>Orificios</i>	<i>Izquierda y derecha</i>
Cobra femurale	Fori	Sinistra e Destra



ENDOSCOPY - SURGERY - DENTAL



Operationstische

Operating tables



Bitte fordern Sie unseren Spezialkatalog an.
Please ask for our special catalogue.

Veillez demander pour notre catalogue spécial.
Por favor preguntan para el catálogo especial.

Per favore domandate per il nostro catalogo speciale.

Kleinfragment / Implantat Set
Small fragment / implant set

Petits fragments - Jeu d'implants
Pequeños fragmentos - Juego de implantes
Piccoli frammenti-Set

TITANK



Bei Bestellung des Sets mit Schrauben und Platten in Titan, bitte der Artikelnummer ein „T“ hinzufügen

For the set with plates and screws in titanium, please add a "T" to the reference number

Pour le jeu avec des plaques et vis en titane, veuillez ajouter un «T» à la référence

Para el juego con placas y tornillos en titano, por favor añadiz un "T" a la referencia

Per il set con viti e placche in titanio, per favore aggiuntete al numero d'articolo un "T"

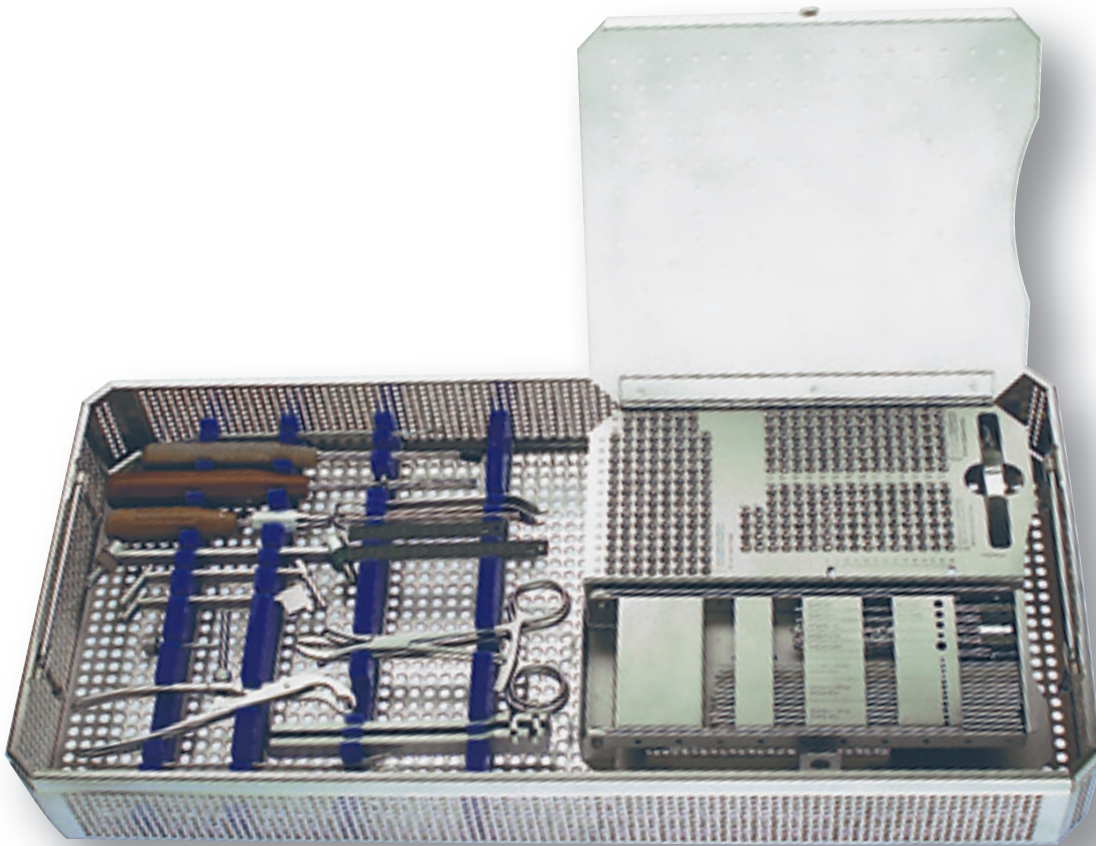

tk 38445-20

Dieser Satz beinhaltet Instrumente der Pos. 01-55, siehe Seite 91-92

This set contents the instruments acc. to pos. 01-55, see page 91-92

Ce jeu contient instruments des positions 01-55, voir page 91-92

Este juego contiene los instrumentos de las posiciones 01-55, veasé pagina 91-92

Questo set contiene gli strumenti delle pos. 01-55, vedi pagina 91-92

Kleinfragment / Implantat Set
Small fragment / implant set

Petits fragments - Jeu d'implants
Pequeños fragmentos - Juego de implantes
Piccoli frammenti-Set

[pos 01]	<i>Container</i>	580x280x135 mm	tk 87180-1F-SI	1 x	→ 0 173
[pos 02]	<i>Tray</i>	540x255x75 mm	tk 87050-58	1 x	
[pos 03]	<i>Drill bit, AO-shaft, 2.5 mm Ø</i>	100/55 mm	tk 38488-04	2 x	→ 0 104
[pos 04]	<i>Drill bit, AO-shaft, 3.5 mm Ø</i>	120/90 mm	tk 38488-08	2 x	→ 0 104
[pos 05]	<i>Countersink with AO-shaft for small screws, 2.0 mm Ø</i>		tk 38389-07	1 x	→ 0 104
[pos 06]	<i>Tap with AO-shaft for 3.5 mm cortex screws</i>	130 mm	tk 38489-34	2 x	→ 0 102
[pos 07]	<i>Tap with AO-Shaft for 4.0 mm cancellous screws</i>		tk 38489-36	2 x	→ 0 102
[pos 09]	<i>Handle for taps with AO-shaft</i>		tk 38388-10	1 x	→ 0 102
[pos 10]	<i>Drill guide and sleeve for drill bit 2.0 mm Ø</i>	20/20 mm	tk 38391-02	1 x	→ 0 103
[pos 11]	<i>Tap sleeve 3.5 mm Ø, sleeve for drill bit 2.5 mm Ø</i>	30/35 mm	tk 38391-03	1 x	→ 0 103
[pos 12]	<i>Insert drill sleeve 3.5 mm Ø / 2.5 mm Ø</i>		tk 38392-35	1 x	→ 0 105
[pos 13]	<i>Screw driver with holding sleeve for hexagonal screws 2.5 mm Ø</i>		tk 38542-10	1 x	→ 0 105
[pos 14]	<i>Screw driver with AO-shaft for hexagonal screws 2.5 mm Ø</i>		tk 38542-11	1 x	→ 0 105
[pos 15]	<i>Depth gauge for small screws</i>	170 mm	tk 38397-02	1 x	→ 0 109
[pos 16]	<i>Neutral and load drill guide 3.5 mm Ø</i>		tk 38392-02	1 x	→ 0 103
[pos 17]	<i>Sharp hook</i>	150 mm	tk 38398-15	1 x	→ 0 109
[pos 18]	<i>Bending iron for plates 3.5 mm Ø</i>		tk 38394-35	1 x	→ 0 110
[pos 19]	<i>Bending iron for plates 2.7 mm Ø</i>		tk 38394-27	1 x	→ 0 110
[pos 20]	<i>Bending iron for 7 hole plates</i>		tk 38541-07	1 x	→ 0 63
[pos 21]	<i>Bending iron for 9 hole plates</i>		tk 38541-09	1 x	→ 0 63
[pos 22]	<i>Bone holding forceps, self-centering</i>	150 mm	tk 24733-15	1 x	→ 0 108
[pos 23]	<i>Reposition forceps</i>	135 mm	tk 24734-14	1 x	→ 0 109
[pos 24]	<i>Bone holding forceps for small fragments</i>	135 mm	tk 24740-14	1 x	→ 0 108
[pos 25] Hohmann	<i>Mini bone lever, 6 mm</i>	160 mm	tk 24551-06	1 x	→ 0 107
[pos 26] Hohmann	<i>Mini bone lever, 8 mm</i>	160 mm	tk 24551-08	1 x	→ 0 107

Kleinfragment / Implantat Set
Small fragment / implant set
Petits fragments - Jeu d'implants
Pequeños fragmentos - Juego de implantes
Piccoli frammenti-Set

[pos 27] Hohmann	<i>Retractor for small fragments</i>		tk 24551-20	2x	→ 0 107
[pos 28]	<i>Periosteal elevator, 6 mm</i>	180 mm	tk 24549-02	1x	→ 0 107
[pos 29]	<i>Screw forceps</i>	80 mm	tk 38399-08	1x	→ 0 109
[pos 30]	<i>Cortical screw, Ø 3.5 mm</i> 10 / 12 / 14 / 16 / 18 / 20 / 22 / 24 / 26 / 28 / 32 / 36 / 40		tk 38407-10 → -40	8x each (total 104 pcs.)	→ 0 100
[pos 31]	<i>Cortical screw, Ø 3.5 mm</i> 45 / 50		tk 38407-45 → -50	6x each (total 12 pcs.)	→ 0 100
[pos 32]	<i>Cancellous screw, Ø 4.0 mm, full thread</i> 14 / 16 / 18 / 20 / 22 / 24 / 26 / 28 / 30 / 32 / 35 / 40 / 45 / 50		tk 38411-14 → -50	6x each (total 84 pcs.)	→ 0 100
[pos 33]	<i>Cancellous screw, Ø 4.0 mm, full thread</i> 55 / 60		tk 38411-55 → -60	4x each (total 8 pcs.)	→ 0 100
[pos 34]	<i>Cancellous screw, Ø 4.0 mm, short thread</i> 12 / 14 / 16 / 18 / 20 / 22 / 24 / 26 / 28 / 30 / 35 / 40 / 45 / 50		tk 38409-12 → -50	6x each (total 84 pcs.)	→ 0 100
[pos 35]	<i>Washer for small cancellous screws, Ø 3.5 / 4.5 mm</i>		tk 38400-00	6x	→ 0 101
[pos 36]	<i>Small T-Plate, right angle, 3 x 3 holes</i>	45 mm	tk 38376-03	1x	→ 0 96
[pos 37]	<i>Small T-Plate, right angle, 4 x 4 holes</i>	56 mm	tk 38378-04	1x	→ 0 96
[pos 38]	<i>Small T-Plate, oblique angle, 3 x 3 holes</i>	52 mm	tk 38378-33	1x	→ 0 97
[pos 39]	<i>Small T-Plate, oblique angle, 5 x 3 holes</i>	74 mm	tk 38378-53	1x	→ 0 97
[pos 40]	<i>One third tubular plates, 2 holes</i>	25 mm	tk 38357-02	1x	→ 0 95
[pos 41]	<i>One third tubular plates, 3 holes</i>	37 mm	tk 38357-03	1x	→ 0 95
[pos 42]	<i>One third tubular plates, 4 holes</i>	49 mm	tk 38357-04	1x	→ 0 95
[pos 43]	<i>One third tubular plates, 5 holes</i>	61 mm	tk 38357-05	2x	→ 0 95
[pos 44]	<i>One third tubular plates, 6 holes</i>	73 mm	tk 38357-06	2x	→ 0 95
[pos 45]	<i>One third tubular plates, 7 holes</i>	85 mm	tk 38357-07	1x	→ 0 95
[pos 46]	<i>One third tubular plates, 8 holes</i>	97 mm	tk 38357-08	1x	→ 0 95
[pos 47]	<i>Cloverleaf plate, shaft 3 holes</i>	88 mm	tk 38380-03	1x	→ 0 97
[pos 48]	<i>Cloverleaf plate, shaft 4 holes</i>	104 mm	tk 38380-04	1x	→ 0 97
[pos 49]	<i>Small fragment plates, 6 holes</i>	74 mm	tk 38375-06	2x	→ 0 94
[pos 50]	<i>Small fragment plates, 7 holes</i>	86 mm	tk 38375-07	2x	→ 0 94
[pos 51]	<i>Small fragment plates, 8 holes</i>	98 mm	tk 38375-08	2x	→ 0 94
[pos 52]	<i>Small fragment plates, 10 holes</i>	122 mm	tk 38375-10	2x	→ 0 94
[pos 53] Kirschner	<i>Wire Ø 1.2 mm</i>	150 mm	tk 38448-12	12x	→ 0 139
[pos 54] Kirschner	<i>Wire Ø 1.6 mm</i>	150 mm	tk 38448-16	12x	→ 0 139
[pos 55] Kirschner	<i>Wire Ø 2.0 mm</i>	150 mm	tk 38448-20	12x	→ 0 139

**MTCP-Platten
MTCP-Plates**

Plaques MTCP
Placas MTCP
Placche MTCP

STAINLESS STEEL



Für Schrauben mit Ø 3,5 mm
For screws with Ø 3.5 mm
Pour vis avec Ø 3.5 mm
Para tornillos con Ø 3.5 mm
Per viti Ø 3.5 mm



Bei Bestellung von Titan
Knochenplatten, bitte der
Artikelnummer ein „T“
hinzufügen.

*For titanium bone plate, please
add a "T" to the reference
number.*

Pour des plaques osseuses en
titane, veuillez ajouter un «T» à
la référence.

*Para placas de titanio, por favor
añadir un "T" a la referencia.*

Per placche in titanio, per favore
aggiuntete al numero d'articolo
un "T".



51 mm - 1½"	4	tk 38348-04
64 mm - 2"	5	tk 38348-05
77 mm - 2¾"	6	tk 38348-06
90 mm - 3½"	7	tk 38348-07
103 mm - 4¼"	8	tk 38348-08
116 mm - 5"	9	tk 38348-09
129 mm - 5½"	10	tk 38348-10
142 mm - 6½"	11	tk 38348-11
155 mm - 7"	12	tk 38348-12

Löcher
Holes
Trous
Orificios
Fori

Kleinfragmentplatten
Small fragment plates

Plaques pour petits fragments
Placas para fracturas pequeñas
Placche per piccoli frammenti

STAINLESS STEEL



Für Schrauben mit Ø 3,5 mm

For screws with Ø 3.5 mm

Pour vis avec Ø 3.5 mm

Para tornillos con Ø 3.5 mm

Per viti con Ø 3.5 mm



T
a
b



		a = 10.0 mm
		b = 3.0 mm
26 mm - 1 "	2	tk 38375-02
38 mm - 1½ "	3	tk 38375-03
50 mm - 2 "	4	tk 38375-04
62 mm - 2½ "	5	tk 38375-05
74 mm - 3 "	6	tk 38375-06
86 mm - 3¼ "	7	tk 38375-07
98 mm - 3¾ "	8	tk 38375-08
110 mm - 4¼ "	9	tk 38375-09
122 mm - 4¾ "	10	tk 38375-10
146 mm - 5¾ "	12	tk 38375-12

Löcher
Holes
Trous
Orificios
Fori

Kleinfragmentplatten
Small fragment plates

Plaques pour petits fragments
Placas para fracturas pequeñas
Placche per frammenti piccoli

STAINLESS STEEL

> Für Schrauben mit Ø 3,5 mm
For screws with Ø 3.5 mm
Pour vis avec Ø 3.5 mm
Para tornillos con Ø 3.5 mm
Per viti con Ø 3.5 mm

Drittelrohrplatten
One-third tubular plates
Plaques de troisième tubulaire
Placas de tercio tubular
Placche di un terzo tubo



> Bei Bestellung von Titan Knochenplatten, bitte der Artikelnummer ein „T“ hinzufügen.

For titanium bone plate, please add a "T" to the reference number.

Pour des plaques osseuses en titane, veuillez ajouter un «T» à la référence.

Para placas de titanio, por favor añadir un "T" a la referencia.

Per placche in titanio, per favore aggiuntete al numero d'articolo un "T".



		a = 12.0 mm
		b = 1.0 mm
		c = 4.1 mm
25 mm - 1 "	2	tk 38357-02
37 mm - 1 ½ "	3	tk 38357-03
49 mm - 2 "	4	tk 38357-04
61 mm - 2 ½ "	5	tk 38357-05
73 mm - 2 ¾ "	6	tk 38357-06
85 mm - 3 ¼ "	7	tk 38357-07
97 mm - 3 ¾ "	8	tk 38357-08
109 mm - 4 ¼ "	9	tk 38357-09
121 mm - 4 ¾ "	10	tk 38357-10
145 mm - 5 ¾ "	12	tk 38357-12

Löcher
Holes
Trous
Orificios
Fori

Kleinfragmentplatten
Small fragment plates

 Plaques pour petits fragments
Placas para fracturas pequeñas
 Placche per frammenti piccoli

STAINLESS STEEL

 Bei Bestellung von Titan
 Knochenplatten, bitte der
 Artikelnummer ein „T“
 hinzufügen.

*For titanium bone plate, please
 add a "T" to the reference
 number.*

 Pour des plaques osseuses en
 titane, veuillez ajouter un «T» à
 la référence.

*Para placas de titanio, por favor
 añadir un "T" a la referencia.*

 Per placche in titanio, per favore
 aggiungete al numero d'articolo
 un "T".

45 mm - 1¾"	3 x 3	3.5 mm Ø	tk 38376-03
67 mm - 2¾"	3 x 5	3.5 mm Ø	tk 38376-05

Löcher <i>Holes</i>	für Kortikalis Schrauben <i>for cortical screws</i>	T-Platten <i>T-plates</i>
Trous <i>Orificios</i>	pour vis corticales <i>para tornillos corticales</i>	Plaques en T <i>Placas en T</i>
Fori	per viti corticali	Placche forma T



56 mm - 2¼"	4 x 4	3.5 mm Ø	tk 38378-04
78 mm - 3"	4 x 6	3.5 mm Ø	tk 38378-06

Löcher <i>Holes</i>	für Kortikalis Schrauben <i>for cortical screws</i>	T-Platten <i>T-plates</i>
Trous <i>Orificios</i>	pour vis corticales <i>para tornillos corticales</i>	Plaques en T <i>Placas en T</i>
Fori	per viti corticali	Placche forma T

Kleinfragmentplatten
Small fragment plates

Plaques pour petits fragments
Placas para fracturas pequeñas
Placche per frammenti piccoli

STAINLESS STEEL



Bei Bestellung von Titan Knochenplatten, bitte der Artikelnummer ein „T“ hinzufügen.

For titanium bone plate, please add a "T" to the reference number.

Pour des plaques osseuses en titane, veuillez ajouter un «T» à la référence.

Para placas de titanio, por favor añadir un "T" a la referencia.

Per placche in titanio, per favore aggiuntete al numero d'articolo un "T".

52 mm - 2"	3 x 3	3.5 mm Ø	tk 38378-33
63 mm - 2½"	4 x 3	3.5 mm Ø	tk 38378-43
74 mm - 3"	5 x 3	3.5 mm Ø	tk 38378-53

Löcher <i>Holes</i>	für Kortikalis Schrauben <i>for cortical screws</i>	T-Platten, schrägwinklig <i>T-plates, oblique</i>
Trous <i>Orificios</i>	pour vis corticales <i>para tornillos corticales</i>	Plaques en T, oblique <i>Placas en T, oblicuas</i>
Fori	per viti corticali	Placche forma T, oblique



88 mm - 3½"	3	3.5 mm Ø	tk 38380-03
104 mm - 4"	4	3.5 mm Ø	tk 38380-04

Schaftlöcher <i>Shaft holes</i>	für Kortikalis Schrauben <i>for cortical screws</i>	Kleeblatt Platten <i>Cloverleaf plates</i>
Tige <i>Tija</i>	pour vis corticales <i>para tornillos corticales</i>	Plaques en forme de trefle <i>Placas een forma de trébol</i>
Fori	per viti corticali	Placche a forma trifoglio

Kleinfragmentplatten
Small fragment plates

Plaques pour petits fragments
Placas para fracturas pequeñas
Placche per frammenti piccoli

STAINLESS STEEL



Für Schrauben:

- Ø 3,5 mm - Kortikalis
- Ø 4,0 mm - Spongiosa

For screws:

- Ø 3.5 mm - Cortical
- Ø 4.0 mm - Cancellous

Pour vis:

- Ø 3.5 mm - Corticalis
- Ø 4.0 mm - Spongiosa

Para tornillos:

- Ø 3.5 mm - Corticalis
- Ø 4.0 mm - Spongiosa

Per viti:

- Ø 3.5 mm - Corticali
- Ø 4.0 mm - Spongiosa



Bei Bestellung von Titan Knochenplatten, bitte der Artikelnummer ein „T“ hinzufügen.

For titanium bone plate, please add a "T" to the reference number.

Pour des plaques osseuses en titane, veuillez ajouter un «T» à la référence.

Para placas de titanio, por favor añadir un "T" a la referencia.

Per placche in titanio, per favore aggiuntete al numero d'articolo un "T".

		a = 10.0 mm	a = 10.0 mm
		b = 2.8 mm	b = 3.6 mm
		c = 12.0 mm	c = 12.0 mm
34 mm - 1¼ "	3	tk 38386-03	
46 mm - 1¾ "	4	tk 38386-04	
58 mm - 2¼ "	5	tk 38386-05	
70 mm - 2¾ "	6	tk 38386-06	tk 38387-06
82 mm - 3¼ "	7	tk 38386-07	
94 mm - 3¾ "	8	tk 38386-08	tk 38387-08
106 mm - 4¼ "	9	tk 38386-09	
118 mm - 4½ "	10	tk 38386-10	tk 38387-10
130 mm - 5 "	11	tk 38386-11	
142 mm - 5½ "	12	tk 38386-12	tk 38387-12
154 mm - 6 "	13	tk 38386-13	
166 mm - 6½ "	14	tk 38386-14	tk 38387-14
178 mm - 7 "	15	tk 38386-15	
190 mm - 7½ "	16	tk 38386-16	tk 38387-16
214 mm - 8½ "	18	tk 38386-18	tk 38387-18
238 mm - 9¼ "	20	tk 38386-20	
262 mm - 10¼ "	22	tk 38386-22	

Rekonstruktionsplatten	Löcher	gerade	gebogen
<i>Reconstruction plates</i>	<i>Holes</i>	<i>straight</i>	<i>curved</i>
Plaques à reconstruction	Trous	droits	courbe
<i>Placas para reconstrucción</i>	<i>Orificios</i>	<i>recta</i>	<i>curva</i>
Placche per ricostruzione	Fori	retta	curva

Kleinfragmentplatten
Small fragment plates

Plaques pour petits fragments
Placas para fracturas pequeñas
Placche per frammenti piccoli

STAINLESS STEEL



Für Schrauben:
Ø 3,5 mm - Kortikalis
Ø 4,0 mm - Spongiosa
For screws:
Ø 3.5 mm - Cortical
Ø 4.0 mm - Cancellous
Pour vis:
Ø 3.5 mm - Corticalis
Ø 4.0 mm - Spongiosa
Para tornillos:
Ø 3.5 mm - Corticalis
Ø 4.0 mm - Spongiosa
Per viti:
Ø 3.5 mm - Corticali
Ø 4.0 mm - Spongiosa



Bei Bestellung von Titan
Knochenplatten, bitte der
Artikelnummer ein „T“
hinzufügen.

*For titanium bone plate, please
add a "T" to the reference
number.*

Pour des plaques osseuses en
titane, veuillez ajouter un «T» à
la référence.

*Para placas de titanio, por favor
añadir un "T" a la referencia.*

Per placche in titanio, per favore
aggiuntete al numero d'articolo
un "T".

a = 8.0 mm
b = 2.7 mm
c = 8.0 mm

48 mm - 2"	6	tk 38390-66
64 mm - 2½"	8	tk 38390-68
80 mm - 3¼"	10	tk 38390-70
96 mm - 3¾"	12	tk 38390-72
112 mm - 4½"	14	tk 38390-74
128 mm - 5"	16	tk 38390-76
144 mm - 5½"	18	tk 38390-78
160 mm - 6¼"	20	tk 38390-80
176 mm - 7"	22	tk 38390-82
192 mm - 7½"	24	tk 38390-84

Rekonstruktionsplatten <i>Reconstruction plates</i>	Löcher <i>Holes</i>	gerade <i>straight</i>
Plaques à reconstruction <i>Placas para reconstrucción</i>	Trous <i>Orificios</i>	droits <i>recta</i>
Placche per riconstruzione	Fori	retta

Kleinfragment Knochenschrauben
Small fragment bone screws

Petites vis osseuses
Tornillos pequeños para huesos
Viti piccoli per ossa

STAINLESS STEEL



	a = 3.5 mm Ø	a = 3.5 mm Ø	a = 4.0 mm Ø	a = 4.0 mm Ø
	b = 2.4 mm Ø	b = 1.9 mm Ø	b = 1.9 mm Ø	b = 1.9 mm Ø
	c = 6.0 mm Ø	c = 6.0 mm Ø	c = 6.0 mm Ø	c = 6.0 mm Ø
	d = 1.25 mm	d = 1.75 mm	d = 1.75 mm	d = 1.75 mm
				e = 2.3 mm Ø
10 mm - 1/2"	tk 38407-10	tk 38408-10	tk 38411-10	tk 38409-10
12 mm - 1/2"	tk 38407-12	tk 38408-12	tk 38411-12	tk 38409-12
14 mm - 1/2"	tk 38407-14	tk 38408-14	tk 38411-14	tk 38409-14
16 mm - 3/4"	tk 38407-16	tk 38408-16	tk 38411-16	tk 38409-16
18 mm - 3/4"	tk 38407-18	tk 38408-18	tk 38411-18	tk 38409-18
20 mm - 3/4"	tk 38407-20	tk 38408-20	tk 38411-20	tk 38409-20
22 mm - 3/4"	tk 38407-22	tk 38408-22	tk 38411-22	tk 38409-22
24 mm - 1"	tk 38407-24	tk 38408-24	tk 38411-24	tk 38409-24
26 mm - 1"	tk 38407-26	tk 38408-26	tk 38411-26	tk 38409-26
28 mm - 1"	tk 38407-28	tk 38408-28	tk 38411-28	tk 38409-28
30 mm - 1 1/4"	tk 38407-30	tk 38408-30	tk 38411-30	tk 38409-30
32 mm - 1 1/4"	tk 38407-32	tk 38408-32	tk 38411-32	
34 mm - 1 1/4"	tk 38407-34	tk 38408-34		
35 mm - 1 1/4"			tk 38411-35	tk 38409-35
36 mm - 1 1/2"	tk 38407-36	tk 38408-36		
38 mm - 1 1/2"	tk 38407-38	tk 38408-38		
40 mm - 1 1/2"	tk 38407-40	tk 38408-40	tk 38411-40	tk 38409-40
45 mm - 1 3/4"	tk 38407-45	tk 38408-45	tk 38411-45	tk 38409-45
50 mm - 2"	tk 38407-50	tk 38408-50	tk 38411-50	tk 38409-50
55 mm - 2 1/4"	tk 38407-55	tk 38408-55	tk 38411-55	
60 mm - 2 1/4"	tk 38407-60	tk 38408-60	tk 38411-60	
65 mm - 2 1/2"	tk 38407-65			
70 mm - 2 3/4"	tk 38407-70			
75 mm - 3"	tk 38407-75			
80 mm - 3 1/4"	tk 38407-80			

Standard	Kortikalis	Spongiosa	Spongiosa	Spongiosa
Standard	Cortical	Cancellous	Cancellous	Cancellous
Standard	Corticalis	Spongiosa	Spongiosa	Spongiosa
Estandar	Corticalis	Spongiosa	Spongiosa	Spongiosa
Standard	Corticale	Spongiosa	Spongiosa	Spongiosa



Bei Bestellung von Titan Schrauben, bitte der Artikelnummer ein „T“ hinzufügen.

For titanium screws, please add a "T" to the reference number.

Pour des vis en titane, veuillez ajouter un «T» à la référence.

Para tornillos de titanio, por favor añadir und "T" a la referencia.

Per viti in titanio, per favore aggiuntete al numero d'articolo un "T".

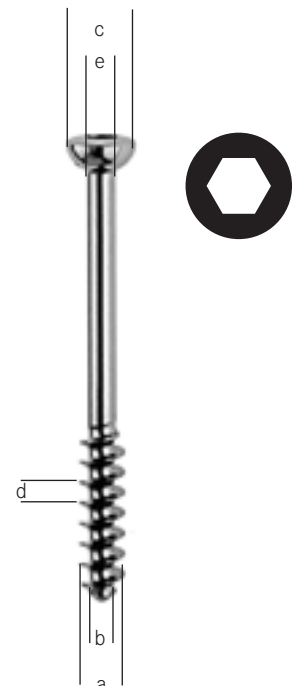

Kleinfragment Knochenschrauben
Small fragment bone screws

Petites vis osseuses
Tornillos pequeños para huesos
Viti per ossa piccoli

STAINLESS STEEL



Bei Bestellung von Titan Schrauben, bitte der Artikelnummer ein „T“ hinzufügen.

For titanium screws, please add a "T" to the reference number.

Pour des vis en titane, veuillez ajouter un «T» à la référence.

Para tornillos de titanio, por favor añadir un "T" a la referencia.

Per viti in titanio, per favore aggiungete al numero d'articolo un "T".



a = 3.5 mm Ø
b = 2.4 mm Ø
c = 6.0 mm Ø
d = 1.25 mm

10 mm - 1/2"	tk 38425-10
12 mm - 1/2"	tk 38425-12
14 mm - 1/2"	tk 38425-14
16 mm - 3/4"	tk 38425-16
18 mm - 3/4"	tk 38425-18
20 mm - 3/4"	tk 38425-20
22 mm - 3/4"	tk 38425-22
24 mm - 1"	tk 38425-24
26 mm - 1"	tk 38425-26
28 mm - 1"	tk 38425-28
30 mm - 1 1/4"	tk 38425-30
32 mm - 1 1/4"	tk 38425-32
34 mm - 1 1/4"	tk 38425-34
36 mm - 1 1/2"	tk 38425-36
38 mm - 1 1/2"	tk 38425-38
40 mm - 1 1/2"	tk 38425-40
45 mm - 1 3/4"	tk 38425-45
50 mm - 2"	tk 38425-50
55 mm - 2 1/4"	tk 38425-55
60 mm - 2 1/4"	tk 38425-60
65 mm - 2 1/2"	tk 38425-65
70 mm - 2 3/4"	tk 38425-70
75 mm - 3"	tk 38425-75
80 mm - 3 1/4"	tk 38425-80



tk 38400-00

Unterlegscheibe
Washer
Rondelle
Arandela
Rondelle

Selbstschneidend Kortikalis
Self cutting *Cortical*
Auto coupante Corticalis
Auto cortante *Corticalisa*
Autofilettante Corticali

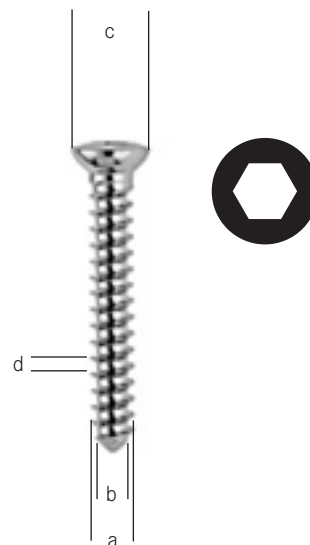

Kleinfragment Instrumentarium
Small fragment instruments

 Instruments pour petits fragments
Instrumentos para fragmentos pequeños
 Strumenti per frammenti piccoli

	3.5 mm Ø	1.25 mm pitch	tk 38489-34
	3.5 mm Ø	1.75 mm pitch	tk 38489-35
	4.0 mm Ø	1.75 mm pitch	tk 38489-36
Gewindeschneider <i>Taps</i>	für Schrauben <i>for screws</i>	Gewindesteigung <i>Pitch</i>	AO Anschluß <i>AO connector</i>
Tarands <i>Terraja</i>	pour vis <i>para tornillos</i>	Pas de filetage <i>Paso de rosca</i>	Raccord AO <i>Connector AO</i>
Taglia filetto/maschiatore	per viti	passo di filetto	Attacco AO

tk 38388-10

 Griff für AO-Schaft 38489-34/35/40
Handles for AO shaft 38489-34/35/40
 Poignée pour tiges AO 38489-34/35/40
Mango para tija AO 38489-34/35/40
 Manico per 38489-34/35/40

Kleinfragment Instrumentarium
Small fragment instruments

Instruments pour petits fragments
Instrumentos para fragmentos pequeños
Strumenti per frammenti piccoli



x = 20 mm / y = 20 mm

tk 38391-02

Ziel- und Plattenbohrbüchse für 2 mm Ø Bohrer
Drill guide and sleeve for 2 mm Ø drill

Guide de perçage pour mèches de 2 mm Ø
Guía de perforación para brocas de 2 mm Ø
Guida perforatore per perf. di Ø 2mm



x = 35 mm / y = 30 mm

3.5 mm / 2.5 mm Ø

2.0 mm / 2.7 mm Ø

tk 38391-03

tk 38391-11

Gewebeschutzhülse / Bohrbüchse
Drill guide

Guide de perçage
Guía de perforación
Protettore di tessuti / Guida perforatore



2.5 mm Ø

3.5 mm Ø

tk 38392-02

Neutral- und Spannbohrbüchse
Neutral and load drill guide

für Bohrer
for drill bits
pour mèches
para brocas
per punte

für Kortikalis Schrauben
for cortical screws
pour vis corticales
para tornillos corticales
per viti corticale

Guide de perçage
Guía de perforación
Guida perforatore

Kleinfragment Instrumentarium
Small fragment instruments

Instruments pour petits fragments
Instrumentos para fragmentos pequeños
 Strumenti per frammenti piccoli



2.5 mm Ø	100 / 55 mm	tk 38488-04
3.5 mm Ø	120 / 90 mm	tk 38488-08

Länge	AO Anschluß
<i>Length</i>	<i>AO connector</i>
Longueur	Raccord AO
<i>Longitud</i>	<i>Connector AO</i>
Lunghezza	Attacco AO



2.0 mm Ø	70 mm - 2¾"	2.7 / 3.5 / 4.0 mm Ø	tk 38389-07
----------	-------------	----------------------	--------------------

Länge	für Schrauben	Kopfraumfräser
<i>Length</i>	<i>for screws</i>	<i>Countersink</i>
Longueur	pour vis	Mèche
<i>Longitud</i>	<i>para tornillos</i>	<i>Broca</i>
Lunghezza	per viti	Fresa per testa vite

Kleinfragment Instrumentarium
Small fragment instruments

Instruments pour petits fragments
Instrumentos para fragmentos pequeños
Strumenti per frammenti piccoli



tk 38542-10

Schraubendreher für 2,5 mm Ø Hexagonalschrauben mit Haltehülse
Screw driver hexagonal screws for 2.5 mm Ø, with holding sleeve

Tournevis pour vis hexagondes de 2.5 mm Ø, avec porte-vis
Destornillador para tornillos hexagonales de 2.5 mm Ø, con porta-tornillos
Giravite per viti esagonali di Ø 2.5 mm con portaviti



tk 38542-11

Schraubendreher mit AO-Schaft 2,5 mm Ø für Handgriff tk 38388-10
Hexagonal screw driver with AO-shaft 2.5 mm Ø for handle tk 38388-10

Tournevis pour vis hexagonales de 2.5 mm Ø, raccord AO pour poignée tk 38388-10
Destornillador para tornillos hexagonales de 2.5 mm Ø, connector AO para mango tk 38388-10
Giravite con attacco AO per manico tk 38388-10 per viti di Ø 2.5 mm



tk 38392-35

	2.5 mm Ø	3.5 mm Ø
Steckbohrbüchse <i>Drill guide</i>	für Bohrer <i>for drills</i>	für Kortikalis Schrauben <i>for cortical screws</i>
Guide de perçage <i>Guía de perforación</i>	pour mèches <i>para brocas</i>	pour vis corticales <i>para tornillos corticales</i>
Guida per perforazione	per punte di trapano	per viti corticali

Schraubendreher
Screw driver

Tourne-vis
Destornilladores
Giraviti



	1.5 mm Ø	2.5 mm Ø	3.5 mm Ø
120 mm - 4¾"	tk 38542-15	-	-
200 mm - 8"	-	tk 38542-25	-
250 mm - 9¾"	-	-	tk 38542-35

für Sechskantschrauben
for hexagonal screws

pour vis hexagonal
para tornillos hexagonales
Per viti esagonali



WILLIAMS

	3.5 mm Ø
240 mm - 9½"	tk 38548-04

für Sechskantschrauben
for hexagonal head

pour vis hexagonal
para tornillos hexagonales
per viti esagonali

Kleinfragment Instrumentarium
Small fragment instruments

Instruments pour petits fragments
Instrumentos para fragmentos pequeños
Strumenti per frammenti piccoli



**MINI-
HOHMANN**

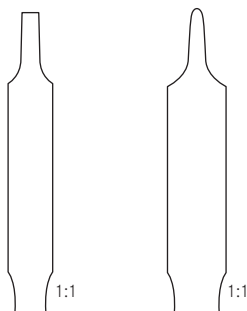

	6 mm	8 mm
160 mm - 6 1/4"	tk 24551-06	tk 24551-08



HOHMANN

tk 24551-20

Knochenhebel
Bone lever
Levier à os
Elevador para huesos
Leva ossa



x = 6 mm

tk 24549-02

Knochenhebel
Bone lever
Levier à os
Elevador para huesos
Leva ossa

Kleinfragment Instrumentarium
Small fragment instruments

Instruments pour petits fragments
Instrumentos para fragmentos pequeños
Strumenti per frammenti piccoli



150 mm - 6"	x = 12.5 mm	tk 24733-15
-------------	-------------	--------------------

selbstzentrierend
self-centering
auto-centreur
autocentrante
autocentrante



135 mm - 5 1/4"

tk 24740-14



tk 38572-20	2.7 mm / 3.5 mm
--------------------	-----------------

Biegezange <i>Bending plier</i>	für Platten <i>for plates</i>
Pince pliante	pour plaques
<i>Pinza para torcer</i>	<i>para placas</i>
Pinza per piegare	per placche

Kleinfragment Instrumentarium
Small fragment instruments

Instruments pour petits fragments
Instrumentos para fragmentos pequeños
Strumenti per frammenti piccoli



150 mm - 6"

tk 38398-15

Haken, scharf
Hook, sharp

Crochet tranchant
Gancho cortante
Gancio acuto



tk 38397-02

2.7 - 4.0 mm Ø

Messinstrument
Depth gauge

Calibre de profondeur
Calibrador de profundidad
Calibro di profondita

für Schrauben
for screws

pour vis
para tornillos
per viti



135 mm - 5¼"

tk 24734-14

1:2



80 mm - 3¼"

tk 38399-08

Schraubenpinzette
Forceps for screws

Pince pour vis
Pinza para tornillos
Pinza porta viti

Kleinfragment Instrumentarium
Small fragment instruments

Instruments pour petits fragments
Instrumentos para fragmentos pequeños
Strumenti per frammenti piccoli



tk 38394-15	Mini
tk 38394-27	2.7 mm Ø
tk 38394-35	3.5 mm Ø
Biegehebel <i>Bending iron</i>	für Platten <i>for plates</i>
Outil pour plier des plaques <i>Instrumento para doblar placas</i>	pour plaques <i>para placas</i>
Leva per piegare placche	per placche



ELECTRO SURGERY

Elektro Chirurgie
Electro surgery

Eléctrochirurgie
Electro-Cirugía
Elettrobisturi



Bitte fordern Sie unseren Spezialkatalog an.
Please ask for our special catalogue.

Veuillez demander pour notre catalogue spécial.
Por favor preguntan para el catálogo especial.

Per favore domandate per il nostro catalogo speciale.

Mini Implantate und Instrumentarium
Mini implants and instruments

Mini implants et instruments
Mini implantes y instrumentos
Set Mini impianti e strumentario

TITANK



Bei Bestellung des Sets mit Schrauben und Platten in Titan, bitte der Artikelnummer ein „T“ hinzufügen

For the set with plates and screws in titanium, please add a "T" to the reference number

Pour le jeu avec des plaques et vis en titane, veuillez ajouter un «T» à la référence

Para el juego con placas y tornillos en titanio, por favor añadiz un "T" a la referencia

Per il set con viti e placche in titanio, per favore aggiuntete al numero d'articolo un "T"

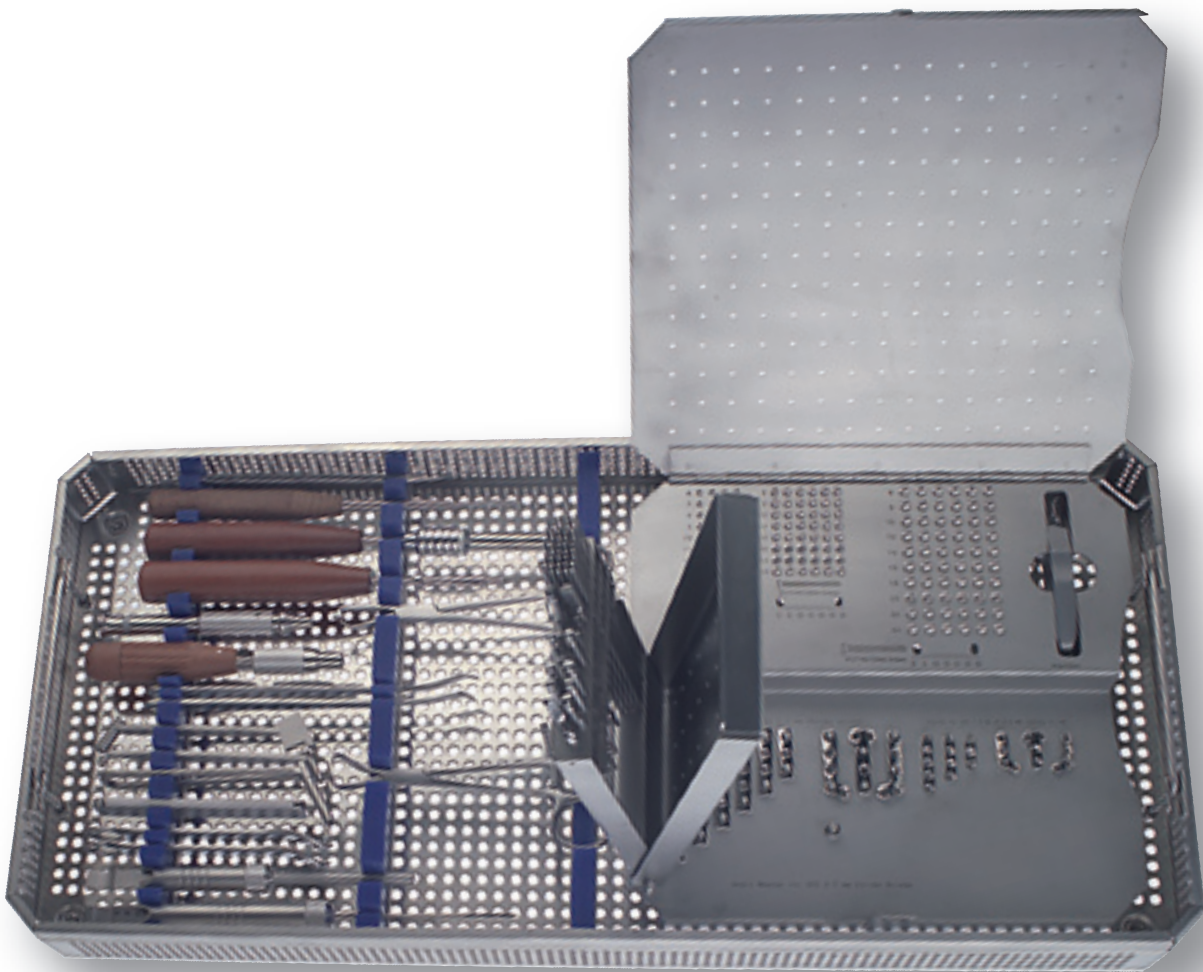

tk 38445-30

Dieser Satz beinhaltet Instrumente der Pos. 01-52, siehe Seite 113-115

This set contents the instruments acc. to pos. 01-52, see page 113-115

Ce jeu contient instruments des positions 01-52, voir page 113-115

Este juego contiene los instrumentos de las posiciones 01-52, veasé pagina 113-115

Questo set contiene gli strumenti delle pos. 01-52, vedi pagina 113-115

Mini Implantate und Instrumentarium
Mini implants and instruments

 Mini implants et instruments
Mini implantes y instrumentos
 Set Mini impianti e strumentario

[pos 01]	<i>Container</i>	580 x 280 x 100 mm	tk87170-1F-SI	1 x	→ O 173
[pos 02]	<i>Tray</i>	540 x 255 x 65 mm	tk87070-04	1 x	
[pos 03]	<i>Drill Bit, 2.0 mm Ø, with quick coupling</i>		tk38488-03	2 x	→ O 121
[pos 04]	<i>Drill Bit, 2.7 mm Ø, with quick coupling</i>		tk38488-05	2 x	→ O 121
[pos 05]	<i>Small countersink with end to fit quick coupling handle</i>		tk38389-07	1 x	→ O 123
[pos 06]	<i>Tap 2.7 mm Ø with end to fit quick coupling handle</i>		tk38489-27	2 x	→ O 121
[pos 07]	<i>Handle with quick coupling</i>		tk38388-10	1 x	→ O 122
[pos 08]	<i>Drill Guide and Drill Sleeve for 2.0 mm Ø Drill Bit</i>		tk38391-02	1 x	→ O 103
[pos 09]	<i>Tap Sleeve 3.5 mm Ø</i>		tk38391-04	1 x	→ O 124
[pos 10]	<i>Small hexagonal screwdriver 2.5 mm with holding sleeve</i>		tk38542-10	1 x	→ O 122
[pos 11]	<i>Depth Gauge (only for 2.7 mm screws)</i>		tk38397-02	1 x	→ O 123
[pos 12]	<i>Drill Bit, 1.1 mm Ø, with quick coupling</i>		tk38488-01	2 x	→ O 121
[pos 13]	<i>Drill Bit, 1.5 mm Ø, with quick coupling</i>		tk38488-02	2 x	→ O 121
[pos 14]	<i>Mini countersink to fit handle with quick coupling</i>		tk38389-05	1 x	→ O 123
[pos 15]	<i>Tap 1.5 mm Ø to fit handle with mini quick coupling</i>		tk38489-15	2 x	→ O 121
[pos 16]	<i>Tap 2.0 mm Ø to fit handle with mini quick coupling</i>		tk38489-20	2 x	→ O 121
[pos 17]	<i>Handle with mini quick coupling</i>		tk38388-09	1 x	→ O 122
[pos 17]	<i>Mini Drill Sleeve for 1.1 mm Ø and 1.5 mm Ø Drill Bits</i>		tk38391-01	1 x	→ O 123
[pos 18]	<i>Mini Depth Gauge (only for 2.0 mm screws)</i>		tk38397-01	1 x	→ O 123
[pos 19]	<i>Sharp hook</i>		tk38398-15	1 x	→ O 124
[pos 20]	<i>Hexagonal screw driver 1.5 mm with holding sleeve</i>		tk38542-08	1 x	→ O 122
[pos 21]	<i>Bending iron for mini and finger plates</i>		tk38394-15	1 x	→ O 110
[pos 22]	<i>Holding forceps for small plates</i>	135 mm	tk24725-12	2 x	→ O 168
[pos 23]	<i>Reduction forceps with points</i>	135 mm	tk24734-14	1 x	→ O 109

Mini Implantate und Instrumentarium
Mini implants and instruments
Mini implants et instruments
Mini implantes y instrumentos
Set Mini impianti e strumentario

MINI-HOHMANN [pos 24]	<i>Small retractor, 6 mm</i>		tk 24551-06	1 x	→ 0 107
MINI-HOHMANN [pos 25]	<i>Small retractor, 8 mm</i>		tk 24551-08	1 x	→ 0 107
HOHMANN [pos 26]	<i>Retractor for small fragments with broad shank, short</i>		tk 24551-20	2 x	→ 0 107
[pos 27]	<i>Periosteal Elevator, small, with straight edge 3 mm</i>		tk 24549-03	1 x	→ 0 122
[pos 28]	<i>Screw forceps self holding</i>		tk 38399-08	1 x	→ 0 109
[pos 29]	<i>Cortex screws, 2.7 mm Ø 6 / 8 / 10 / 12 / 14 / 16 / 18 / 20 / 22 / 24 mm</i>		tk 38405-06 → -24	6 x each (total 60 pcs.)	→ 0 119
[pos 30]	<i>Small washer for 2.7 mm Ø screws</i>		tk 38400-00	6 x	→ 0 101
[pos 31]	<i>Quarter Tubular Plate for 2.7 mm Ø Cortex Screws Length 25 mm / 3 Hole</i>		tk 38355-03	2 x	→ 0 117
[pos 32]	<i>Quarter Tubular Plate for 2.7 mm Ø Cortex Screws Length 33 mm / 4 Hole</i>		tk 38355-04	2 x	→ 0 117
[pos 33]	<i>Quarter Tubular Plate for 2.7 mm Ø Cortex Screws Length 41 mm / 5 Hole</i>		tk 38355-05	2 x	→ 0 117
[pos 34]	<i>Quarter Tubular Plate for 2.7 mm Ø Cortex Screws Length 49 mm / 6 Hole</i>		tk 38355-06	2 x	→ 0 117
[pos 35]	<i>Quarter Tubular Plate for 2.7 mm Ø Cortex Screws Length 57 mm / 7 Hole</i>		tk 38355-07	2 x	→ 0 117
[pos 36]	<i>Quarter Tubular Plate for 2.7 mm Ø Cortex Screws Length 65 mm / 8 Hole</i>		tk 38355-08	2 x	→ 0 117
[pos 37]	<i>L-Plate, oblique left 3/2 holes</i>		tk 38360-13	2 x	→ 0 118
[pos 38]	<i>L-Plate, oblique right 3/2 holes</i>		tk 38360-33	2 x	→ 0 118
[pos 39]	<i>T-Plate, shaft 3/2 holes</i>		tk 38360-03	4 x	→ 0 118
[pos 40]	<i>Kirschner wires with Trocar, 0.8 mm Ø Length 70 mm</i>		tk 38479-08	10 x each	→ 0 139
[pos 41]	<i>Kirschner wires with Trocar, 1.0 mm Ø Length 70 mm</i>		tk 38479-10	10 x each	→ 0 139
[pos 42]	<i>Kirschner wires with Trocar, 1.0 mm Ø Length 150 mm</i>		tk 38448-10	10 x each	→ 0 139
[pos 43]	<i>Kirschner wires with Trocar, 1.2 mm Ø Length 150 mm</i>		tk 38448-12	10 x each	→ 0 139
[pos 44]	<i>Kirschner wires with Trocar, 1.6 mm Ø Length 150 mm</i>		tk 38448-16	10 x each	→ 0 139
[pos 45]	<i>Cortex screws, 1.5 mm Ø 6 / 7 / 8 / 9 / 10 / 11 / 12 / 14 / 16 mm</i>		tk 38401-06 → -16	4 x each (total 36 pcs.)	→ 0 119
[pos 46]	<i>Cortex screws, 2.0 mm Ø 6 / 8 / 10 / 12 / 14 / 16 / 18 / 20 mm</i>		tk 38403-06 → -20	6 x each (total 48 pcs.)	→ 0 119

Mini Implantate und Instrumentarium
Mini implants and instruments

Mini implants et instruments
Mini implantes y instrumentos
 Set Mini impianti e strumentario

[pos 47]	<i>Mini plate, 2.0 mm Ø straight, 3 hole Length 17 mm</i>		tk 38360-53	2x	→ O 118
[pos 48]	<i>Mini plate, 2.0 mm Ø straight, 4 hole Length 23 mm</i>		tk 38360-54	2x	→ O 118
[pos 49]	<i>Mini plate, 2.0 mm Ø straight, 5 hole Length 29 mm</i>		tk 38360-55	2x	→ O 118
[pos 50]	<i>Mini L-plate, 2.0 mm Ø oblique left, 2/2 hole</i>		tk 38360-12	2x	→ O 118
[pos 51]	<i>Mini L-plate, 2.0 mm Ø oblique right, 2/2 hole</i>		tk 38360-22	2x	→ O 118
[pos 52]	<i>Mini T-plate, 2.0 mm Ø, 2/2 hole</i>		tk 38360-02	4x	→ O 118

Mini-Fragment Platten
Mini-fragment plates

 Plaques pour mini-fragments
Placas para mini-fragmentos
 Placche per frammenti mini

STAINLESS STEEL

Für Ø 2,0 mm Kortikalis Schrauben
For Ø 2.0 mm cortical screws
 Pour vis corticales Ø 2.0 mm
Para tornillos corticales de Ø 2.0 mm
 Per viti corticali di Ø 2.0 mm



		a = 1.0 mm
		b = 5.0 mm
		c = 5.0 mm
22 mm - ¾"	4	tk 38339-04
27 mm - 1"	5	tk 38339-05
32 mm - 1 ¼"	6	tk 38339-06
37 mm - 1 ½"	7	tk 38339-07
42 mm - 1 ¾"	8	tk 38339-08

Löcher	Kompressionsplatten
Holes	<i>Compression plates</i>
Trous	Plaques de compression
Orificios	<i>Placas de compresión</i>
Fori	Placche a compressione

Für Ø 2,7 mm Kortikalis Schrauben
For Ø 2.7 mm cortical screws
 Pour vis corticales Ø 2.7 mm
Para tornillos corticales de Ø 2.7 mm
 Per viti corticali a Ø 2.7 mm



		a = 2.0 mm	a = 2.5 mm
		b = 8.0 mm	b = 8.0 mm
		c = 8.0 mm	c = 8.0 mm
20 mm - ¾"	2	tk 38337-02	
36 mm - 1 ½"	4	tk 38337-04	
44 mm - 1 ¾"	5	tk 38337-05	
52 mm - 2"	6	tk 38337-06	
60 mm - 2 ¼"	7		tk 38337-07
68 mm - 2 ¾"	8		tk 38337-08
76 mm - 3"	9		tk 38337-09
84 mm - 3 ¼"	10		tk 38337-10
100 mm - 4"	12		tk 38337-12

Löcher	Kompressionsplatten
Holes	<i>Compression plates</i>
Trous	Plaques de compression
Orificios	<i>Placas de compresión</i>
Fori	Placche a compressione



Bei Bestellung von Titan Knochenplatten, bitte der Artikelnummer ein „T“ hinzufügen.

For titanium bone plate, please add a "T" to the reference number.

Pour des plaques osseuses en titane, veuillez ajouter un «T» à la référence.

Para placas de titanio, por favor añadir un "T" a la referencia.

Per placche in titanio, per favore aggiuntete al numero d'articolo un "T".



T
α
= b L

Knochenplatten
Bone plates

Plaques osseuses
Placas para huesos
Placche per ossa

STAINLESS STEEL



Für Schrauben mit Ø 2,7 mm
For screws with Ø 2.7 mm
Pour vis avec Ø 2.7 mm
Para tornillos con Ø 2.7 mm
Per viti Ø 2.7 mm

Viertelrohrplatten

Quarter-tubular plates

Plaques tubulaire de quart tubulaire
Placas cuarto tubulares
Placche quarto tubulare

TITANK



Bei Bestellung von Titan Knochenplatten, bitte der Artikelnummer ein „T“ hinzufügen.

For titanium bone plate, please add a "T" to the reference number.

Pour des plaques osseuses en titane, veuillez ajouter un «T» à la référence.

Para placas de titanio, por favor añadir un "T" a la referencia.

Per placche in titanio, per favore aggiuntete al numero d'articolo un "T".



		a = 7.0 mm
		b = 1.0 mm
		c = 3.3 mm Ø
25 mm - 1 "	3	tk 38355-03
33 mm - 1¼ "	4	tk 38355-04
41 mm - 1½ "	5	tk 38355-05
49 mm - 2 "	6	tk 38355-06
57 mm - 2¼ "	7	tk 38355-07
65 mm - 2½ "	8	tk 38355-08

Löcher
Holes
Trous
Orificios
Fori

Mini-Fragment Platten
Mini-fragment plates

Plaques pour mini-fragments
Placas para mini-fragmentos
Placche per frammenti mini

STAINLESS STEEL

Für Ø 2,0 mm Kortikalis Schrauben
For Ø 2.0 mm cortical screws
Pour vis corticales Ø 2.0 mm
Para tornillos corticales de Ø 2.0 mm
Per viti corticali di Ø 2.0 mm



	a = 1.0 mm	a = 1.0 mm	a = 1.0 mm
	b = 5.0 mm	b = 5.0 mm	b = 5.0 mm
2	tk 38360-02	tk 38360-12	tk 38360-22

Löcher Holes	T-Platten T-plates	schräg, links oblique left	schräg, rechts oblique right
Trous	Plaques en T	oblique gauche	oblique droite
Orificios	Placas en T	oblicuo izquierda	oblicuo derecha
Fori	Placche forma T	oblique sinistra	oblique destra



Bei Bestellung von Titan Knochenplatten, bitte der Artikelnummer ein „T“ hinzufügen.

For titanium bone plate, please add a "T" to the reference number.

Pour des plaques osseuses en titane, veuillez ajouter un «T» à la référence.

Para placas de titanio, por favor añadir un "T" a la referencia.

Per placche in titanio, per favore aggiungete al numero d'articolo un "T".



Für Ø 2,7 mm Kortikalis Schrauben
For Ø 2.7 mm cortical screws
Pour vis corticales Ø 2.7 mm
Para tornillos corticales Ø 2.7 mm
Per viti corticali a Ø 2.7 mm



		a = 1.2 mm
		b = 7.0 mm
17 mm - ¾"	3	tk 38360-53
25 mm - 1"	4	tk 38360-54
29 mm - 1¼"	5	tk 38360-55
35 mm - 1½"	6	tk 38360-56

Löcher Holes	T-Platten T-plates
Trous	Plaques en T
Orificios	Placas en T
Fori	Placche forma T

	a = 1.2 mm	a = 1.2 mm	a = 1.2 mm
	b = 7.0 mm	b = 7.0 mm	b = 7.0 mm
3	tk 38360-03	tk 38360-13	tk 38360-33

Löcher Holes	T-Platten T-plates	schräg, links oblique left	schräg, rechts oblique right
Trous	Plaques en T	oblique gauche	oblique droite
Orificios	Placas en T	oblicuo izquierda	oblicuo derecha
Fori	Placche forma T	oblique sinistra	oblique destra

Mini Fragment Schrauben
Mini fragment screws

Vis pour mini fragments
Tornillos para mini fragmentos
Viti per frammenti mini

STAINLESS STEEL



Bei Bestellung von Titan Schrauben, bitte der Artikelnummer ein „T“ hinzufügen.

For titanium screws, please add a "T" to the reference number.

Pour des vis en titane, veuillez ajouter un «T» à la référence.

Para tornillos de titanio, por favor añadir und "T" a la referencia.

Per viti in titanio, per favore aggiuntete al numero d'articolo un "T".



	a = 1.5 mm Ø	a = 2.0 mm Ø	a = 2.7 mm Ø
	b = 1.0 mm Ø	b = 1.3 mm Ø	b = 1.9 mm Ø
	c = 3.0 mm Ø	c = 4.0 mm Ø	c = 5.0 mm Ø
6 mm - ¼ "	tk 38401-06	tk 38403-06	tk 38405-06
7 mm - ¼ "	tk 38401-07		
8 mm - ¼ "	tk 38401-08	tk 38403-08	tk 38405-08
9 mm - ¼ "	tk 38401-09		
10 mm - ½ "	tk 38401-10	tk 38403-10	tk 38405-10
11 mm - ½ "	tk 38401-11		
12 mm - ½ "	tk 38401-12	tk 38403-12	tk 38405-12
14 mm - ½ "	tk 38401-14	tk 38403-14	tk 38405-14
16 mm - ¾ "	tk 38401-16	tk 38403-16	tk 38405-16
18 mm - ¾ "	tk 38401-18	tk 38403-18	tk 38405-18
20 mm - ¾ "	tk 38401-20	tk 38403-20	tk 38405-20
22 mm - ¾ "		tk 38403-22	tk 38405-22
24 mm - 1 "		tk 38403-24	tk 38405-24
26 mm - 1 "			tk 38405-26
28 mm - 1 "			tk 38405-28
30 mm - 1 ¼ "			tk 38405-30
32 mm - 1 ¼ "			tk 38405-32
34 mm - 1 ¼ "			tk 38405-34
36 mm - 1 ½ "			tk 38405-36
38 mm - 1 ½ "			tk 38405-38
40 mm - 1 ½ "			tk 38405-40



Standard
Standard
Standard
Estandar
Standard

Mini Fragment Schrauben
Mini fragment screws

Vis pour mini fragments
Tornillos para mini fragmentos
Viti per frammenti mini

STAINLESS STEEL

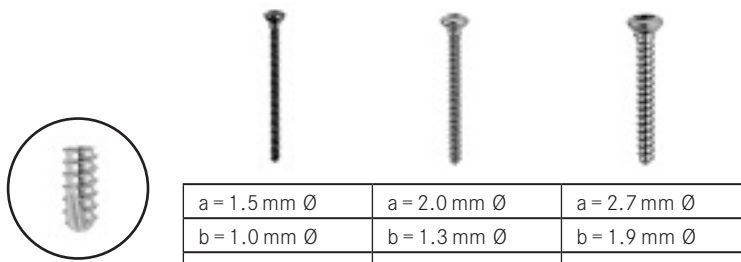

	a = 1.5 mm Ø	a = 2.0 mm Ø	a = 2.7 mm Ø
6 mm - 1/4"	tk 38427-06	tk 384 13-06	tk 38402-06
7 mm - 1/4"	tk 38427-07		
8 mm - 1/4"	tk 38427-08	tk 384 13-08	tk 38402-08
9 mm - 1/4"	tk 38427-09		
10 mm - 1/2"	tk 38427-10	tk 384 13-10	tk 38402-10
11 mm - 1/2"	tk 38427-11		
12 mm - 1/2"	tk 38427-12	tk 384 13-12	tk 38402-12
14 mm - 1/2"	tk 38427-14	tk 384 13-14	tk 38402-14
16 mm - 3/4"	tk 38427-16	tk 384 13-16	tk 38402-16
18 mm - 3/4"	tk 38427-18	tk 384 13-18	tk 38402-18
20 mm - 3/4"	tk 38427-20	tk 384 13-20	tk 38402-20
22 mm - 3/4"		tk 384 13-22	tk 38402-22
24 mm - 1"		tk 384 13-24	tk 38402-24
26 mm - 1"		tk 384 13-26	tk 38402-26
28 mm - 1"		tk 384 13-28	tk 38402-28
30 mm - 1 1/4"		tk 384 13-30	tk 38402-30
32 mm - 1 1/4"		tk 384 13-32	tk 38402-32
34 mm - 1 1/4"		tk 384 13-34	tk 38402-34
36 mm - 1 1/2"		tk 384 13-36	tk 38402-36
38 mm - 1 1/2"		tk 384 13-38	tk 38402-38
40 mm - 1 1/2"		tk 384 13-40	tk 38402-40

Selbstschneidend
Self tapping

Auto coupante
Auto cortante
Autofilettante

TITANTK



Bei Bestellung von Titan Schrauben, bitte der Artikelnummer ein „T“ hinzufügen.

For titanium screws, please add a "T" to the reference number.

Pour des vis en titane, veuillez ajouter un «T» à la référence.

Para tornillos de titanio, por favor añadir una "T" a la referencia.

Per viti in titanio, per favore aggiungete al numero d'articolo un "T".



Instrumentarium für Mini-Fragment Platten
Instruments for mini-fragment plates

Instruments pour plaques pour mini-fragments
Instrumentos para placas para mini-fragmentos
 Strumenti per frammenti mini



1.5 mm Ø	tk 38489-15
2.0 mm Ø	tk 38489-20
2.7 mm Ø	tk 38489-27

Gewindeschneider mit AO Anschluß
Tap with AO connector

Taraud avec raccord AO
Roscador con connector AO
 Maschiatore con attacco AO

1.1 mm Ø	65 / 35 mm	tk 38488-01
1.5 mm Ø	85 / 60 mm	tk 38488-02
2.0 mm Ø	100 / 75 mm	tk 38488-03
2.5 mm Ø	110 / 85 mm	tk 38488-04
2.7 mm Ø	100 / 75 mm	tk 38488-05

Bohrer <i>Drill</i>	Länge <i>Length</i>	AO Anschluß <i>AO connector</i>
Mèche <i>Broca</i>	Longueur <i>Longitud</i>	Raccord AO <i>Connector AO</i>
Trapano	Lunghezza	Attacco AO

Instrumentarium für Mini-Fragment Platten
Instruments for mini-fragment plates

Instruments pour plaques pour mini-fragments
Instrumentos para placas para mini-fragmentos
Strumenti per frammenti mini



tk 38388-09

Griff für AO-Schaft
Tap handles for AO shaft
Poignée pour tiges AO
Mango para tija AO
Manico per attacco AO



tk 38388-10

Griff für AO-Schaft
Tap handles for AO shaft
Poignée pour tiges AO
Mango para tija AO
Manico per attacco AO



x = 3 mm

tk 24549-03

Elevator
Periosteal elevator
Elevateur
Elevador
Elevatore



1.5 mm Ø

tk 38542-08

2.7 mm Ø

tk 38542-10

Schraubendreher für Hexagonalschrauben, mit Haltehülse
Screw driver for hexagonal screws with holding sleeve
Tournevis pour vis hexagonales de, avec porte-vis
Destornillador para tornillos hexagonales, con porta-tornillos
Giravite per viti esagonali con portaviti

Instrumentarium für Mini-Fragment Platten
Instruments for mini-fragment plates

Instruments pour plaques pour mini-fragments
Instrumentos para placas para mini-fragmentos
 Strumenti per frammenti mini



1.1 mm Ø	tk 38389-05	55 mm - 2¼"	1.5 - 2.0 mm Ø
2.0 mm Ø	tk 38389-07	70 mm - 2¾"	2.7 - 4.0 mm Ø

Kopfraumfräser <i>Countersink</i>	Länge <i>Length</i>	für Schrauben <i>for screws</i>
Mèche <i>Brocas</i>	Longueur <i>Longitud</i>	pour vis <i>para tornillos</i>
Frese per testa vite	Lunghezza	per viti



tk 38397-01	1.5-2.0 mm Ø
tk 38397-02	2.7-4.0 mm Ø

Messinstrument <i>Depth gauge</i>	für Schrauben <i>for screws</i>
Calibre de profondeur <i>Calibrador de profundidad</i>	pour vis <i>para tornillos</i>
Calibro di profondita	per viti



tk 38391-01	1.1 mm / 1.5 mm Ø
tk 38391-08	1.5 mm / 2.0 mm Ø

Mini-Bohrbüchse <i>Mini drill sleeve</i>	für Bohrer <i>for drill</i>
Mini guide de perçage <i>Mini guía de perforación</i>	pour mèche <i>para broca</i>
Mini guida perforatore	per punte

Instrumentarium für Mini-Fragment Platten
Instruments for mini-fragment plates

Instruments pour plaques pour mini-fragments
Instrumentos para placas para mini-fragmentos
Strumenti per frammenti mini



2.7 mm / 3.5 mm Ø

tk 38391-04

für Gewindeschneider
for taps

pour tarauds
para roscadores
per maschiatori

Gewebeschutzhülse
Drill guide

Guide de perçage
Guía de perforación
Protettore tessuti / Guida perforatore



150 mm - 6"

tk 38398-15

Haken, scharf
Hook, sharp

Crochet tranchant
Gancho cortante
Uncino acuto

Hohlschrauben für Osteosynthese
Cannulated screws for osteosynthesis

Vis canulées pour ostéo-syntese
Tornillos huecos para osteosintesis
Viti cannulati per ossa

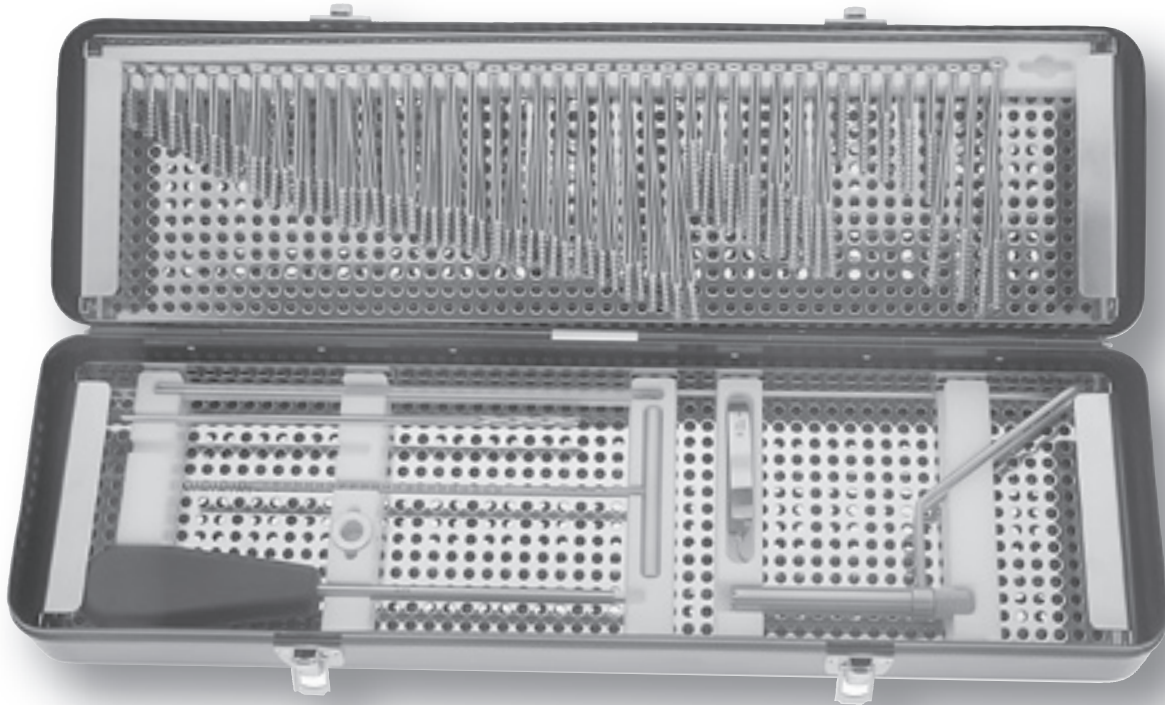

tk38444-50

Dieser Satz beinhaltet Instrumente der Pos. 01-19, siehe Seite 127

This set contents the instruments acc. to pos. 01-19, see page 127

Ce jeu contient instruments des positions 01-19, voir page 127

Este juego contiene los instrumentos de las posiciones 01-19, veasé pagina 127

Questo set contiene gli strumenti delle pos. 01-19, vedi pagina 127

Hohlschrauben für Osteosynthese
Cannulated screws for osteosynthesis

Vis canulées pour ostéo-synthese
Tornillos huecos para osteosintesis
Viti cannulati per ossa

[pos 01]	Container	495 x 140 x 80 mm	tk87235-1F-RE	1 x	
[pos 02]	Upper Tray	470 x 130 x 30 mm	tk87070-10	1 x	
[pos 03]	Lower Tray	470 x 130 x 30 mm	tk87070-11	1 x	
[pos 04]	Cannulated screws 7.0 mm Ø, 16.0 mm thread 30 / 35 / 40 / 45 / 50 / 55 / 60 / 65 / 70 / 75 mm		tk 38420-30 → -75	2 x each (total 20 pcs.)	→ O 128
[pos 05]	Cannulated screws 7.0 mm Ø, 16.0 mm thread 80 / 85 / 90 mm		tk 38420-70 → -90	4 x each (total 12 pcs.)	→ O 128
[pos 06]	Cannulated screws 7.0 mm Ø, 16.0 mm thread 95 / 100 / 105 / 110 mm		tk 38420-95 → -10	2 x each (total 8 pcs.)	→ O 128
[pos 07]	Cannulated screws 7.0 mm Ø, 16.0 mm thread 115 / 120 / 125 / 130 mm		tk 38421-15 → -30	1 x each (total 4 pcs.)	→ O 128
[pos 08]	Cannulated screws 7.0 mm Ø, 32.0 mm thread 45 / 50 / 55 / 60 / 65 / 70 / 75 / 80 / 85 / 90 mm		tk 38421-45 → -90	2 x each (total 20 pcs.)	→ O 128
[pos 09]	Cannulated screws 7.0 mm Ø, 32.0 mm thread 95 / 100 / 105 / 110 / 115 / 120 / 125 / 130 mm		tk 38421-95 → -30	1 x each (total 8 pcs.)	→ O 128
[pos 10]	Washers, 19.0 mm Ø, for cannulated screws		tk 38438-19	6 x	→ O 130
[pos 11]	Drill bit, 5.0 mm Ø	180 mm - 7 "	tk 38433-01	1 x.	→ O 129
[pos 12]	Tap, 7.0 mm Ø	210 mm - 8 ¼ "	tk 38436-07	1 x	→ O 129
[pos 13]	Screw driver for screws with a Ø of 7.0 mm	240 mm - 9 ½ "	tk 38435-24	1 x	→ O 129
[pos 14]	Tissue protection sleeve	200 mm - 7 ¾ "	tk 38441-00	1 x	→ O 130
[pos 15]	Guide wire, 2.0 mm Ø, for cannulated screws	230 mm - 9 "	tk 38440-20	10 x	→ O 128
[pos 16]	Screw forceps	80 mm - 3 ¼ "	tk 38399-08	1 x	→ O 136
[pos 17]	Measure gange for screws 7.0 mm Ø		tk 38397-12	1 x	→ O 130
[pos 18]	Cannulated counter sink	230 mm - 9 "	tk 38389-20	1 x	→ O 129
[pos 19]	Canal cleaner 2.0 mm Ø		tk 38399-20	1 x	→ O 130

Hohlschrauben für Osteosynthese
Cannulated screws for osteosynthesis
Vis canulées pour ostéo-syntese
Tornillos huecos para osteosintesis
Viti cannulati per ossa
STAINLESS STEEL

Für 2.0 mm Ø Führungsspieße und 5,0 mm Ø Bohrer
For 2.0 mm Ø guide wires and 5.0 mm Ø drills
Pour broches de guide 2.0 mm Ø et mèche 5.0 mm Ø
Para guías de 2.0 mm Ø y broca de 5.0 mm Ø
Per filo guida Ø 2.0 mm e punta da trapano Ø 5.0 mm

	7.0 mm Ø	7.0 mm Ø	7.0 mm Ø
	16.0 mm thread	32.0 mm thread	full thread
30 mm - 1 1/4"	tk 38420-30		
35 mm - 1 1/4"	tk 38420-35		
40 mm - 1 1/2"	tk 38420-40		
45 mm - 1 3/4"	tk 38420-45	tk 38421-45	tk 38423-45
50 mm - 2"	tk 38420-50	tk 38421-50	tk 38423-50
55 mm - 2 1/4"	tk 38420-55	tk 38421-55	tk 38423-55
60 mm - 2 1/4"	tk 38420-60	tk 38421-60	tk 38423-60
65 mm - 2 1/2"	tk 38420-65	tk 38421-65	tk 38423-65
70 mm - 2 3/4"	tk 38420-70	tk 38421-70	tk 38423-70
75 mm - 3"	tk 38420-75	tk 38421-75	tk 38423-75
80 mm - 3 1/4"	tk 38420-80	tk 38421-80	tk 38423-80
85 mm - 3 1/4"	tk 38420-85	tk 38421-85	tk 38423-85
90 mm - 3 1/2"	tk 38420-90	tk 38421-90	tk 38423-90
95 mm - 3 3/4"	tk 38420-95	tk 38421-95	tk 38423-95
100 mm - 4"	tk 38420-00	tk 38421-00	tk 38423-00
105 mm - 4 1/4"	tk 38420-05	tk 38421-05	tk 38423-05
110 mm - 4 1/4"	tk 38420-10	tk 38421-10	tk 38423-10
115 mm - 4 1/2"	tk 38420-15	tk 38421-15	tk 38423-15
120 mm - 4 3/4"	tk 38420-20	tk 38421-20	tk 38423-20
125 mm - 5"	tk 38420-22	tk 38421-25	tk 38423-25
130 mm - 5"	tk 38420-24	tk 38421-30	tk 38423-30

	230 mm - 9"
2.0 mm Ø	tk 38440-20

Standard	Kannulierte Schrauben, Kurzgewinde	Vollgewinde
Standard	<i>Cannulated screws, short thread</i>	<i>Full thread</i>
Standard	Vis canulées, filet court	Filet longue
<i>Estandar</i>	<i>Tornillos huecos, rosca corta</i>	<i>Rosca larga</i>
Standard	Viti cannulati, filetto corte	Filetto pieno

Führungsspieß für kannulierte Schrauben, Ø 7 mm
Guide wire for cannulated screws, Ø 7 mm

Broche de guide pour vis canulées, Ø 7 mm
Hilo de guía para tornillos acanalados, Ø 7 mm

Filo guida per viti cannulati di Ø 7 mm

Instrumentarium für Hohlschrauben
Instruments for cannulated screws

Instruments pour vis canulée
Instrumentos para tornillos huecos
Strumenti per viti cannulati



	180 mm - 7"
5.0 mm Ø	tk 38433-01

Bohrer
Drill bit
Mèche
Broca
Punta da trapano



	240 mm - 9½"
	tk 38435-24

Schraubenzieher für Schrauben mit 7,0 mm Ø
Screw driver for screws with a Ø of 7.0 mm
Tournevis pour vis de 7.0 mm Ø
Destornillador para tornillos de 7.0 mm Ø
Giraviti per viti di 7.0 mm Ø

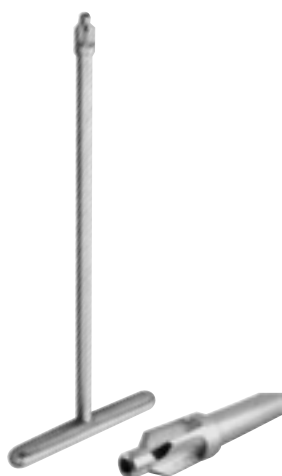

	230 mm - 9"
	tk 38389-20

Kopfraumfräser, kannuliert
Counter sink, cannulated
Mèche, canulée
Broca, acanalada
Fresa spazio festa di vite, cannulata



	210 mm - 8¼"
4.5 mm Ø	tk 38436-04
7.0 mm Ø	tk 38436-07

Gewindeschneider
Tap
Taraud
Roscador
Taglia filetto

Instrumentarium für Hohlschrauben
Instruments for cannulated screws

Instruments pour vis canulée
Instrumentos para tornillos huecos
Strumenti per viti cannulati

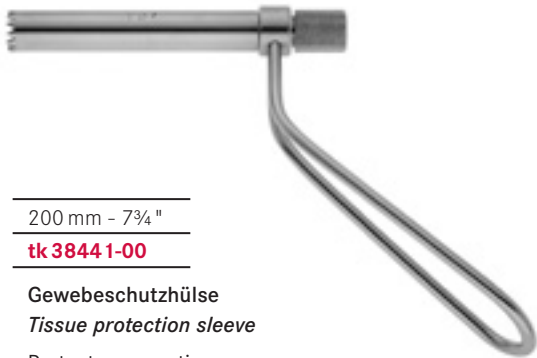

200 mm - 7¾"

tk 38441-00

Gewebeschutzhülse
Tissue protection sleeve
Protecteur pour tissu
Guía de protección
Protettore di tessuti



7.0 mm Ø

tk 38397-12

für Schrauben <i>for screws</i>	Messstab <i>Measuring gauge</i>
pour vis <i>para tornillos</i>	Règle <i>Regla</i>
per viti	Misuratore



tk 38399-10

Halteklammer
Holding clamp
Epingle
Grapa
Graffa



2.0 mm Ø

tk 38399-20

Reinigungsdraht
Canal cleaner

Fil de nettoyage
Hilo de limpieza
Filo di pulitura

2.1 mm Ø

tk 38399-21

Reinigungsbürste
Canal brush

Brosse
Cepillo
spazzola di pulitura



13.0 mm Ø

tk 38438-13

16.0 mm Ø

tk 38438-16

19.0 mm Ø

tk 38438-19

Unterlegscheiben für kannulierte Schrauben
Washers for cannulated screws
Rondelles pour vis canulées
Arandelas para tornillos huecos
Rondella per viti cannulati

Instrumentarium für Hohlschrauben
Instruments for cannulated screws

Instruments pour vis canulée
Instrumentos para tornillos huecos
Strumenti per viti cannulati



170 mm - 6 $\frac{3}{4}$ "

tk 38439-17

Zielgerät für Führungsspieße Ø 2.0 mm
Parallel target device for guide wires Ø 2.0 mm

Viseur pour broches de guide Ø 2.0 mm
Centrador para hilos de guía Ø 2.0 mm
Centratore per filo guida Ø 2.0 mm

Hohlschrauben für Osteosynthese
Cannulated screws for osteosynthesis

Vis canulées pour ostéo-syntese
Tornillos huecos para osteosintesis
Viti canulati per osteosintesi

STAINLESS STEEL

➤ Für 1.2 mm Ø und 1.6 mm Ø Führungsspieße
For 1.2 mm Ø and 1.6 mm Ø guide wires
Pour broches de guide 1.2 mm Ø et 1.6 mm Ø
Para guías de 1.2 mm Ø y 1.6 mm Ø
Per filo guida Ø 1.2 mm e Ø 1.6 mm



➤ Bei Bestellung von Titan Schrauben, bitte der Artikelnummer ein „T“ hinzufügen.

For titanium screws, please add a "T" to the reference number.

Pour des vis en titane, veuillez ajouter un «T» à la référence.

Para tornillos de titanio, por favor añadir un "T" a la referencia.

Per viti in titanio, per favore aggiungete al numero d'articolo un "T".



	a = 3.5 mm Ø	a = 4.5 mm Ø	a = 3.5 mm Ø	a = 4.5 mm Ø
	b = 2.5 mm Ø	b = 3.0 mm Ø	b = 2.5 mm Ø	b = 3.0 mm Ø
	c = 5.0 mm Ø	c = 6.5 mm Ø	c = 5.0 mm Ø	c = 6.5 mm Ø
	d = 1.25 mm		d = 1.25 mm	
			e = 2.5 mm Ø	
	f = 1.3 mm Ø	f = 1.75 mm Ø	f = 1.3 mm Ø	f = 1.75 mm Ø
10 mm - 1/2"	tk 38240-10		tk 38244-10	
12 mm - 1/2"	tk 38240-12		tk 38244-12	
14 mm - 1/2"	tk 38240-14		tk 38244-14	
16 mm - 1/2"	tk 38240-16		tk 38244-16	
18 mm - 3/4"	tk 38240-18		tk 38244-18	
20 mm - 3/4"	tk 38240-20	tk 38242-20	tk 38244-20	tk 38246-20
22 mm - 3/4"	tk 38240-22	tk 38242-22	tk 38244-22	tk 38246-22
24 mm - 1"	tk 38240-24	tk 38242-24	tk 38244-24	tk 38246-24
26 mm - 1"	tk 38240-26	tk 38242-26	tk 38244-26	tk 38246-26
28 mm - 1"	tk 38240-28	tk 38242-28	tk 38244-28	tk 38246-28
30 mm - 1 1/4"	tk 38240-30	tk 38242-30	tk 38244-30	tk 38246-30
32 mm - 1 1/4"	tk 38240-32	tk 38242-32	tk 38244-32	tk 38246-32
34 mm - 1 1/4"	tk 38240-34	tk 38242-34	tk 38244-34	tk 38246-34
36 mm - 1 1/2"	tk 38240-36	tk 38242-36	tk 38244-36	tk 38246-36
38 mm - 1 1/2"	tk 38240-38	tk 38242-38	tk 38244-38	tk 38246-38
40 mm - 1 1/2"	tk 38240-40	tk 38242-40	tk 38244-40	tk 38246-40
42 mm - 1 3/4"	tk 38240-42	tk 38242-42	tk 38244-42	tk 38246-42
44 mm - 1 3/4"	tk 38240-44	tk 38242-44	tk 38244-44	tk 38246-44
46 mm - 1 3/4"	tk 38240-46	tk 38242-46	tk 38244-46	tk 38246-46
48 mm - 2"	tk 38240-48	tk 38242-48	tk 38244-48	tk 38246-48
50 mm - 2"	tk 38240-50	tk 38242-50	tk 38244-50	tk 38246-50
52 mm - 2"		tk 38242-52		tk 38246-52
54 mm - 2 1/4"		tk 38242-54		tk 38246-54
56 mm - 2 1/4"		tk 38242-56		tk 38246-56
58 mm - 2 1/4"		tk 38242-58		tk 38246-58
60 mm - 2 1/4"		tk 38242-60		tk 38246-60

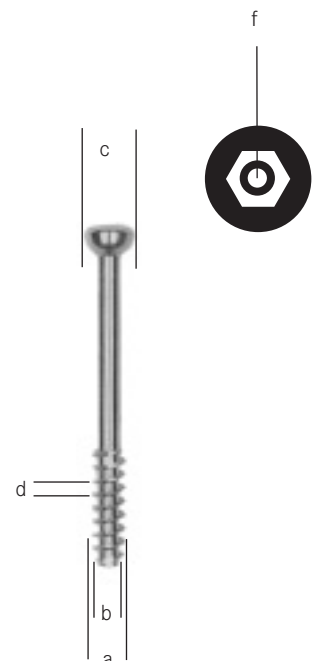

Kannulierte Schrauben, Vollgewinde
Cannulated screws, full thread
Vis canulées
Tornillos huecos
Viti cannulati filetto pieno

Kannulierte Schrauben, Kurzgewinde
Cannulated screws, short thread
Vis canulées, filet court
Tornillos huecos, rosca corta
Viti cannulati, filetto corte

Hohlschrauben für Osteosynthese
Cannulated screws for osteosynthesis

Vis canulées pour ostéo-synthese
Tornillos huecos para osteosintesis
 Viti canulati per osteosintesi



4.5 mm Ø	3.5 mm Ø
tk 38415-11	tk 38415-07

Unterlegscheibe

Washer

Rondelle

Arandela

Rondelle



	150 mm - 6 "
1.2 mm Ø	tk 38440-18

Führungsspieß für kannulierte Schrauben, Ø 3.5mm

Guide wire for cannulated screws, Ø 3.5 mm

Broche de guide pour vis canulées, Ø 3.5 mm

Hilo de guía para tornillos acanalados, Ø 3.5 mm

Filo guida per viti cannulati di 3.5 mm



	230 mm - 9 "
1.6 mm Ø	tk 38440-19

Führungsspieß für kannulierte Schrauben, Ø 4.5mm

Guide wire for cannulated screws, Ø 4.5 mm

Broche de guide pour vis canulées, Ø 4.5 mm

Hilo de guía para tornillos acanalados, Ø 4.5 mm

Filo guida per viti cannulati di 4.5 mm

Instrumentarium für Hohlschrauben
Instruments for cannulated screws

Instruments pour vis canulée
Instrumentos para tornillos huecos
Strumenti per viti cannulati



	195 mm - 7¾"	225 mm - 8¾"
3.5 mm Ø	tk 38437-01	-
4.5 mm Ø	-	tk 38437-02

für Schrauben
for screws
pour vis
para tornillos
per viti

Sechskantschraubenzieher
Screw driver for hexagonal screws
Tourne-vis pour vis hexagonal
Destornilladores para tornillos hexagonales
Giraviti per viti hexagonale



3.5 mm Ø	tk 38437-11
4.5 mm Ø	tk 38437-12

Hülse für Schraubenzieher (tk 38437-01 / -02)
Sleeve for screw driver (tk 38437-01 / -02)
Porte vis pour tourne-vis (tk 38437-01 / -02)
Porta tornillos para destornillador (tk 38437-01 / -02)
Porta vite per giraviti (tk 38437-01 / -02)

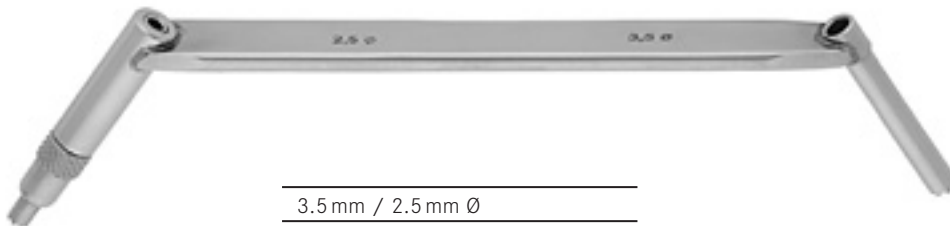

3.5 mm / 2.5 mm Ø

tk 38391-12

Gewebeschutzhülse / Bohrbüchse
Drill guide / protection sleeve

Guide de perçage et de protection
Guía de perforación y de protección
Protettore di tessuti / Guida perforatore

Instrumentarium für Hohlschrauben
Instruments for cannulated screws

Instruments pour vis canulée
Instrumentos para tornillos huecos
Strumenti per viti cannulati



3.5 mm Ø	tk 38489-34
4.5 mm Ø	tk 38489-37

Gewindeschneider mit AO Anschluß
Tap with AO connector
Taraud avec raccord AO
Rosgador con connector AO
Taglia filetto (maschiatore) con attacco AO

			x = 160 mm
2.7 mm Ø	1.35 mm	3.5 mm Ø	tk 38488-50
3.5 mm Ø	1.35 mm	3.5 mm Ø	tk 38488-52
3.2 mm Ø	1.80 mm	4.5 mm Ø	tk 38488-51
4.5 mm Ø	1.80 mm	4.5 mm Ø	tk 38488-53

Kanal	für Schrauben	AO Anschluß
<i>Channel</i>	<i>for screws</i>	<i>AO connector</i>
Canal	pour vis	Raccord AO
<i>Canal</i>	<i>para tornillos</i>	<i>Connector AO</i>
Canale	per viti	Attacco AO



tk 38388-01

Griff für AO-Schaft, kanulliert
Tap handle for AO shaft, cannulated
Poignée pour tige AO, canulée
Mango para tija AO, acnalado
Manico per maschiatore AO, cannulato



2.7 mm Ø / 1.0 mm Ø	3.5 mm Ø	tk 38317-27
4.5 mm Ø / 3.2 mm Ø	4.5 mm Ø	tk 38317-45

Gewebeschutzhülse/Bohrbüchse	für Schrauben
<i>Drill guide / protection sleeve</i>	<i>for screws</i>
Guide de perçage et de protection	pour vis
<i>Guía de perforación y de protección</i>	<i>para tornillos</i>
Protettore tessuti/Guida perforatore	per viti

Instrumentarium für Hohlschrauben
Instruments for cannulated screws

Instruments pour vis canulée
Instrumentos para tornillos huecos
Strumenti per viti cannulati



3.5 - 4.0 mm Ø	tk 38389-19
4.5 mm Ø	tk 38389-18

Kopfraumfräser, kannuliert, für Schrauben
Counter sink, cannulated, for screws

Mèche, canulée, pour vis

Broca, acanalada, para tornillos

Fresa spazio festa di vite, cannulata, per viti



80 mm - 3 1/4"

tk 38399-08

Schraubenpinzette
Forceps for screws

Pince pour vis

Pinza para tornillos

Pinza porta viti



150 mm - 6"

tk 38398-15

Haken, scharf
Hook, sharp

Crochet tranchant

Gancho cortante

Gancio, acuto



3.5 mm Ø

tk 38397-11

4.5 mm Ø

tk 38397-09

für Schrauben
for screws

Messstab
Measuring gauge

pour vis
para tornillos
per viti

Règle
Regla
Misuratore

Instrumentarium für Hohlschrauben
Instruments for cannulated screws

Instruments pour vis canulée
Instrumentos para tornillos huecos
 Strumenti per viti cannulati



1.2 mm Ø	tk 38399-18
1.6 mm Ø	tk 38399-16

Reinigungsdraht
Canal cleaner
 Fil de nettoyage
Hilo de limpieza
 Filo di pulitura



1.35 mm Ø	tk 38399-19
1.75 mm Ø	tk 38399-17

Reinigungsbürste
Canal brush
 Brosse
Cepillo
 spazzola di pulitura

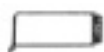

tk 38399-10

Halteklammer
Holding clamp
 Epingle
Grapa
 Graffa



1.5 mm Ø	tk 85201-01
2.0 mm Ø	tk 85201-02
2.7 mm Ø	tk 85201-03
3.5 mm Ø - 1.25 pitch	tk 85201-04
3.5 mm Ø - 1.75 pitch	tk 85201-05
4.0 mm Ø - half threaded	tk 85201-06
4.0 mm Ø - full threaded	tk 85201-07
4.5 mm Ø	tk 85201-08

Gestell für Schrauben (passend für tk 85200-01)
Rack for screws (suitable for tk 85200-01)
 Châssis pour vis (appropriée pour tk 85200-01)
Armazon para tornillos (adecuado para tk 85200-01)
 Cestello per viti (adegnato per tk 85200-01)

Zubehör
Accessories

Accessoires
Accesorios
Accessori



tk 85200-01

Container (ohne Gestelle)
Container (without racks)
Conteneur (sans châssis)
Contenedor (sin armazones)
Contentitore (senza cestelli)



1.5 mm Ø	tk 85201-01
2.0 mm Ø	tk 85201-02
2.7 mm Ø	tk 85201-03
3.5 mm Ø - 1.25 pitch	tk 85201-04
3.5 mm Ø - 1.75 pitch	tk 85201-05
4.0 mm Ø - half threaded	tk 85201-06
4.0 mm Ø - full threaded	tk 85201-07
4.5 mm Ø	tk 85201-08

Gestell für Schrauben (passend für tk 85200-01)
Rack for screws (suitable for tk 85200-01)
Châssis pour vis (appropriée pour tk 85200-01)
Armazon para tornillos (adecuado para tk 85200-01)
Cestello per viti (adegnato per tk 85200-01)



tk 38397-10

Messlehre für Schrauben
Measuring gauge for screws
Calibre pour vis
Calibrador para tornillos
Calibro per viti

Kirschner Bohrdrähte
Kirschner wire drills

Broches Kirschner
Clavos Kirschner
Chiodi Kirschner

STAINLESS STEEL



Weitere Längen auf Anfrage erhältlich
Other lengths are available on request

Autres longueurs disponibles sur demande
Otras longitudes disponibles según demanda
Altre Lunghezze disponibili a richiesta

x

KIRSCHNER				
		x = 70 mm - 2¾"		
0.8 mm Ø	-	tk 38473-08		
1.0 mm Ø	-	tk 38473-10		
1.5 mm Ø	-	tk 38473-15		
2.5 mm Ø	-	tk 38473-25		
	x = 150 mm - 6"	x = 150 mm - 6"	x = 150 mm - 6"	
0.8 mm Ø	tk 38447-08	tk 38448-08	tk 38449-08	
1.0 mm Ø	tk 38447-10	tk 38448-10	tk 38449-10	
1.2 mm Ø	tk 38447-12	tk 38448-12	tk 38449-12	
1.4 mm Ø	tk 38447-14	tk 38448-14	tk 38449-14	
1.5 mm Ø	tk 38447-15	tk 38448-15	tk 38449-15	
1.6 mm Ø	tk 38447-16	tk 38448-16	tk 38449-16	
1.7 mm Ø	tk 38447-17	-	-	
1.8 mm Ø	tk 38447-18	tk 38448-18	tk 38449-18	
2.0 mm Ø	tk 38447-20	tk 38448-20	tk 38449-20	
2.2 mm Ø	tk 38447-22	tk 38448-22	tk 38449-22	
2.5 mm Ø	tk 38447-25	tk 38448-25	tk 38449-25	
3.0 mm Ø	tk 38447-30	tk 38448-30	tk 38449-30	
	x = 310 mm - 12¼"	x = 310 mm - 12¼"	x = 310 mm - 12¼"	x = 310 mm - 12¼"
0.8 mm Ø	tk 38455-08	-	-	-
1.0 mm Ø	tk 38455-10	tk 38456-10	tk 38457-10	tk 38460-10
1.2 mm Ø	tk 38455-12	tk 38456-12	tk 38457-12	tk 38460-12
1.4 mm Ø	tk 38455-14	tk 38456-14	tk 38457-14	-
1.5 mm Ø	tk 38455-15	tk 38456-15	tk 38457-15	tk 38460-15
1.6 mm Ø	tk 38455-16	tk 38456-16	tk 38457-16	tk 38460-16
1.7 mm Ø	tk 38455-17	-	-	tk 38460-17
1.8 mm Ø	tk 38455-18	tk 38456-18	tk 38457-18	tk 38460-18
2.0 mm Ø	tk 38455-20	tk 38456-20	tk 38457-20	tk 38460-20
2.2 mm Ø	tk 38455-22	tk 38456-22	tk 38457-22	tk 38460-22
2.5 mm Ø	tk 38455-25	tk 38456-25	tk 38457-25	tk 38460-25
3.0 mm Ø	-	tk 38456-30	-	tk 38460-30
3.5 mm Ø	-	-	-	tk 38460-35
	Trokar / flach <i>Trocar / flat</i>	Trokar / rund <i>Trocar / round</i>	Trokar / Trokar <i>Trocar / Trocar</i>	Lanze / flach <i>Lancet / flat</i>
	Trocart / plat <i>Trócar / plano</i>	Trocart / rond <i>Trócar / redondo</i>	Trocart / Trocart <i>Trócar / Trócar</i>	Lancette / plat <i>Lanza / plano</i>
	Trequarto / piatto	Trequarto / rotondo	Trequarto / Trequarto	Lancia / piatto

Kirschner Bohrdrähte
Kirschner wire drills

Broches Kirschner
Clavos Kirschner
Fili Kirschner



	120 mm - 4¾"	185 mm - 7¼"	330 mm - 13"
0.8 mm Ø	tk 38477-08	tk 38478-08	tk 38479-08
1.0 mm Ø	tk 38477-10	tk 38478-10	tk 38479-10
1.2 mm Ø	tk 38477-12	tk 38478-12	tk 38479-12
1.4 mm Ø	tk 38477-14	tk 38478-14	tk 38479-14
1.5 mm Ø	tk 38477-15	tk 38478-15	tk 38479-15
1.8 mm Ø	tk 38477-18	tk 38478-18	tk 38479-18
2.0 mm Ø	tk 38477-20	tk 38478-20	tk 38479-20
2.2 mm Ø	tk 38477-22	tk 38478-22	tk 38479-22
2.5 mm Ø	tk 38477-25	tk 38478-25	tk 38479-25
3.0 mm Ø	tk 38477-30	tk 38478-30	tk 38479-30

Schutzhülse zur Sterilisation von Kirschnerdrähten
Protection tube for sterilization of Kirschner wires

Tube de protection et stérilisation des broches Kirschner

Tubo protector para la esterilización de clavos Kirschner

Comicia di protezione per sterilizzazione degli fili Kirschner

Steinmann Nägel - Schanz Schrauben
Steinmann pins - Schanz screws

Broches Steinmann - Vis de Schanz
Clavos Steinmann - Tornillos de Schanz
 Chiodi Steinmann - Viti Schanz

STAINLESS STEEL



STEINMANN

	3.5 mm Ø	4.0 mm Ø	4.5 mm Ø	5.0 mm Ø
120 mm - 4¾"	tk 38469-12	tk 38470-12	tk 38471-12	tk 38472-12
150 mm - 6"	tk 38469-15	tk 38470-15	tk 38471-15	tk 38472-15
180 mm - 7"	tk 38469-18	tk 38470-18	tk 38471-18	tk 38472-18
200 mm - 7¾"	tk 38469-20	tk 38470-20	tk 38471-20	tk 38472-20
250 mm - 9¾"	tk 38469-25	tk 38470-25	tk 38471-25	tk 38472-25
300 mm - 12"	tk 38469-30	tk 38470-30	tk 38471-30	tk 38472-30

mit Trokarspitze und Dreikant Schaftende
with trocar point and triangular shaft end

avec point trocar et fin de la tige triangulaire
con punta trocar y terminal de la tija triangular
 con punta a trequarto ed attacco triangolare



SCHANZ

	3.0 mm Ø	4.0 mm Ø	4.5 mm Ø	5.0 mm Ø
	x = 20 mm	x = 25 mm	x = 50 mm	x = 50 mm
60 mm - 2¼"	tk 38464-06	tk 38465-06		
80 mm - 3¼"	tk 38464-08			
100 mm - 4"		tk 38465-10	tk 38466-10	tk 38467-10
120 mm - 4¾"			tk 38466-12	
125 mm - 5"				tk 38467-12
130 mm - 5"		tk 38465-13		
150 mm - 6"			tk 38466-15	tk 38467-15
170 mm - 6¾"		tk 38465-17	tk 38466-17	tk 38467-17
200 mm - 7¾"			tk 38466-20	tk 38467-20
250 mm - 9¾"			tk 38466-25	tk 38467-25

mit Trokarspitze und Dreikant Schaftende
with trocar point and triangular shaft end

avec point trocar et fin de la tige triangulaire
con punta trocar y terminal de la tija triangular
 con punta a trequarto ed attacco triangolare

Knochenklammern mit Instrumentarium
Staples with instruments

Agrafes et instruments
Grapas y instrumentos
 Staples con strumenti

STAINLESS STEEL



1.5 mm Ø	1.5 mm Ø	2.5 mm Ø	2.5 mm Ø
x = 16 mm	x = 22 mm	x = 16 mm	x = 22 mm
y = 19 mm	y = 19 mm	y = 19 mm	y = 19 mm
tk 38484-16	tk 38484-22	tk 38483-16	tk 38483-22



210 mm - 8¼"

tk 38485-21

Ausschlaginstrument
Staple extractor

Extracteur
Extractor
 Estrattore



160 mm - 6¼"

tk 38486-16

Vorschläger
Staple drives

Impacteur
Impactador
 Impattore



200 mm - 7¾"

tk 38487-20

Instrument zum einsetzen von Knochenklammern
Staple inserter

Instruments pour poser les agrafes
Instrumentos para poner las grapas
 Strumento per inserire a li staples

Drahtinstrumentarium-Set
Wire instrument set

Jeu d'instruments pour cerclage
Juego de instrumentos para cerclaje
Set di strumenti per cerclage

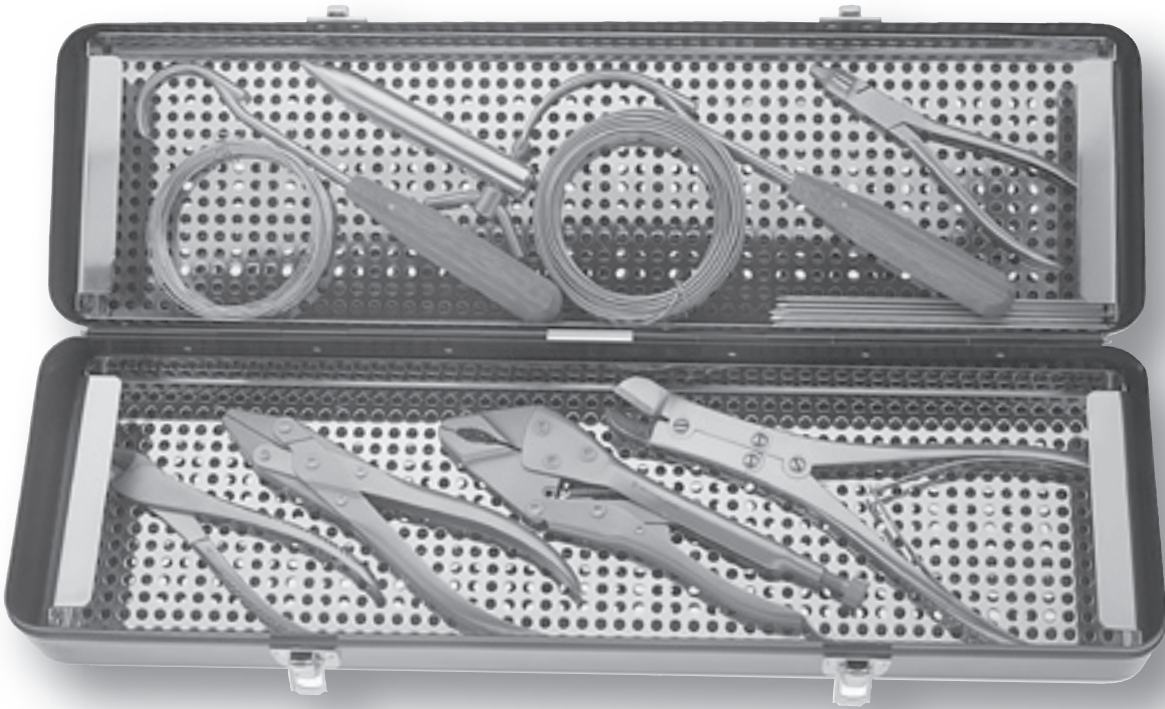

tk 38446-10

Dieser Satz beinhaltet Instrumente der Pos. 01-19, siehe Seite 145

This set contents the instruments acc. to pos. 01-19, see page 145

Ce jeu contient instruments des positions 01-19, voir page 145

Este juego contiene los instrumentos de las posiciones 01-19, vease página 145

Questo set contiene gli strumenti delle pos. 01-19, vedi pagina 145

Drahtinstrumentarium-Set
Wire instrument set

 Jeu d'instruments pour cerclage
 Juego de instrumentos para cerclaje
 Set di strumenti per cerclage

[pos 01]	<i>Container</i>	495 x 140 x 80 mm	tk 87235-1F-RE	1 x	
[pos 02]	<i>Upper tray</i>	470 x 130 x 30 mm	tk 87070-12	1 x	
[pos 03]	<i>Lower tray</i>	470 x 130 x 30 mm	tk 87070-12	1 x	
[pos 04]	<i>Forceps for holding cerclage wire</i>	140 mm - 5 ½ "	tk 20801-15	2 x	→ O 148
[pos 05]	<i>Wire-bending cutting pliers</i>	160 mm - 6 ¼ "	tk 38572-16	1 x	→ O 148
[pos 06]	<i>Wire-bending forceps</i>	170 mm - 6 ½ "	tk 38569-17	1 x	→ O 154
[pos 07]	<i>Grip forceps</i>	180 mm - 7 "	tk 38573-18	1 x	→ O 154
[pos 09]	<i>Wire cutter, small</i>	150 mm - 6 "	tk 38556-15	1 x	→ O 151
[pos 10]	<i>Wire cutter, large</i>	220 mm - 8 ¾ "	tk 38554-22	1 x	→ O 149
[pos 11]	<i>Wire guide 45 mm</i>	200 mm - 8 "	tk 38440-45	1 x	→ O 147
[pos 12]	<i>Wire guide 70 mm</i>	200 mm - 8 "	tk 38440-70	1 x	→ O 147
[pos 13]	<i>Wire tightener</i>	130 mm - 5 "	tk 38532-13	1 x	→ O 146
[pos 14]	<i>Cerclage wires with eye, 1.0 mm Ø, 280 mm long</i>		tk 38552-10	10 x	→ O 146
[pos 15]	<i>Cerclage wires with eye, 1.2 mm Ø, 280 mm long</i>		tk 38552-12	20 x	→ O 146
[pos 16]	<i>Wire coil, 1.0 mm Ø, length 10 meters</i>		tk 38550-10	1 x	→ O 146
[pos 17]	<i>Wire coil, 1.2 mm Ø, length 10 meters</i>		tk 38550-12	1 x	→ O 146
KIRSCHNER [pos 18]	<i>Wire 1.0 / 1.2 / 2.0 / 2.5 / 3.0 mm Ø</i>		tk 38448-10 -12/-20/25/-30	10 x each (total 50 pcs.)	→ O 139
KIRSCHNER [pos 19]	<i>Wire 1.6mm Ø</i>		tk 38448-16	20 x	→ O 139

Drahtinstrumentarium
Wire instruments

Instruments pour cerclage
Instrumentos para cerclaje
Strumenti per cerclage



LOUTE

210 mm - 8¼"

tk 38520-21

1:2



130 mm - 5"

tk 38532-13

1:2



0.2 mm Ø	tk 38550-02
0.3 mm Ø	tk 38550-03
0.4 mm Ø	tk 38550-04
0.5 mm Ø	tk 38550-05
0.6 mm Ø	tk 38550-06
0.7 mm Ø	tk 38550-07
0.8 mm Ø	tk 38550-08
0.9 mm Ø	tk 38550-09
1.0 mm Ø	tk 38550-10
1.2 mm Ø	tk 38550-12
1.5 mm Ø	tk 38550-15

Knochendraht, weich, in Ringen à 10 m
Bone wire, soft, in coils of 10 m

Fil de cerclage, souple, de 10 m

Alambre de cerclaje, blando, de 10 m

Filo per ossa, morbido, anelli da 10 m



0.8 mm Ø x 280 mm	tk 38552-08
1.0 mm Ø x 280 mm	tk 38552-10
1.2 mm Ø x 280 mm	tk 38552-12
1.0 mm Ø x 600 mm	tk 38553-10
1.2 mm Ø x 600 mm	tk 38553-12

Knochendraht mit Auge, weich, Packung à 10 Stück
Bone wire with eye, soft, package of 10 pieces

Fil de cerclage, souple, paquet de 10 pièces

Alambre de cerclaje, blando, paquete de 10 piezas

Filo per ossa con ansa, morbido, confezione di 10 pezzi

Drahtinstrumentarium
Wire instruments

Instruments pour cerclage
Instrumentos para cerclaje
Strumenti per cerclage



	200 mm - 8 "
x = 45 mm	tk 38440-45
x = 70 mm	tk 38440-70



DEMEL
280 mm - 11 "
tk 38518-28



DEMEL	
	280 mm - 11 "
x = 32 mm	tk 38517-01
x = 45 mm	tk 38517-02
x = 62 mm	tk 38517-03

Drahtinstrumentarium
Wire instruments

Instruments pour cerclage
Instrumentos para cerclaje
Strumenti per cerclage



1:2



TEKNO-TWIST

150 mm - 6"

tk 20801-15 tucar

Drahtzange

Wire forceps

Pince pour fils d'acier

Pinza para hilos

Pinze per fili d'acciaio



1:2

160 mm - 6¼"

tk 38572-16

Drahtbiegezange für Drähte, hart 1,0 mm Ø / weich 1,5 mm Ø
Wire bending plier for wires, hard 1.0 mm Ø / soft 1.5 mm Ø

Pince à fils, fils durs 1.0 mm Ø / doux 1.5 mm Ø

Pinza per alombres, duro 1,0 mm Ø / blando 1.5 mm Ø

Pinza piega filo, duroi 1.0 mm Ø / morbidi 1.5 mm Ø

Drahtschneidezangen
Wire cutting forceps

Pinces coupantes
Alicates para cortar alambre
Pinze taglia filo

TUCAR^{TK}



220 mm - 8 3/4 "

tk 3854-22 tucar

für harte Drähte bis 2.2 mm Ø, für weiche Drähte bis 2.8 mm Ø
for hard wires up to 2.2 mm Ø, for soft wires up to 2.8 mm Ø
pour fils durs à 2.2 mm Ø, pour fils souples à 2.8 mm Ø
para alambres duros hasta 2.2 mm Ø, y alambres blandos de 2.8 mm Ø
per fili duri fino 2.2 mm Ø, per fili morbidi fino a 2.8 mm Ø



220 mm - 8 3/4 "

tk 3856 1-22 tucar

für harte Drähte bis 2.2 mm Ø, für weiche Drähte bis 3 mm Ø
for hard wires up to 2.2 mm Ø, for soft wires up to 3 mm Ø
pour fils durs à diam. 2.2 mm Ø, pour fils souples à 3 mm Ø
para alambres duros hasta 2.2 mm Ø, y alambres blandos de 3 mm Ø
per fili duri fino 2.2 mm Ø, per fili morbidi fino a 3 mm Ø

Drahtschneidezangen
Wire cutting forceps

Pinces coupantes
Alicates para cortar alambre
Pinze taglia filo

TUCAR TK



230 mm - 9"

tk38554-23 tucar

für harte Drähte bis 2.2 mm Ø, für weiche Drähte bis 3 mm Ø
for hard wires up to 2.2 mm Ø, for soft wires up to 3 mm Ø
pour fils durs à 2.2 mm Ø, pour fils souples à 3 mm Ø
para alambres duros hasta 2.2 mm Ø, y alambres blandos de 3 mm Ø
per fili duri fino 2.2 mm Ø, per fili morbidi fino a 3 mm Ø



260 mm - 10¼"

tk38560-26 tucar

für harte Drähte bis 3 mm Ø
for hard wires up to 3 mm Ø
pour fils durs à 3 mm Ø
para alambres duros hasta 3 mm Ø
per fili duri fino a 3 mm Ø

Drahtschneidezangen
Wire cutting forceps

Pinces coupantes
Alicates para cortar alambre
Pinze taglia filo



1:2

180 mm – 7" | **tk38555-18 tucar**

für harte Drähte bis 1.5 mm Ø, für weiche Drähte bis 2 mm Ø
for hard wires up to 1.5 mm Ø, for soft wires up to 2 mm Ø
pour fils durs à 1.5 mm Ø, pour fils souples à 2 mm Ø
para alambres duros hasta 1.5 mm Ø, y alambres blandos de 2 mm Ø
per fili duri fino 1.5 mm Ø, per fili duri morbidi fino a 2 mm Ø



1:2

180 mm – 7" | **tk 38557-18 tucar**

für harte Drähte bis 1.7 mm Ø, für weiche Drähte bis 2 mm Ø
for hard wires up to 1.7 mm Ø, for soft wires up to 2 mm Ø
pour fils durs à 1.7 mm Ø, pour fils souples à 2 mm Ø
para alambres duros hasta 1.7 mm Ø, y alambres blandos de 2 mm Ø
per fili duri fino 1.7 mm Ø, per fili morbidi fino a 2 mm Ø



1:2

150 mm – 6" | **tk38556-15 tucar**

für harte Drähte bis 1 mm Ø, für weiche Drähte bis 1.5 mm Ø
for hard wires up to 1 mm Ø, for soft wires up to 1.5 mm Ø
pour fils durs à 1 mm Ø, pour fils souples à 1.5 mm Ø
para alambres duros hasta 1 mm Ø, y alambres blandos de 1.5 mm Ø
per fili duri fino 1 mm Ø, per fili morbidi fino a 1.5 mm Ø



1:2

145 mm – 5¾" | **tk38561-14 tucar**

für harte Drähte bis 1 mm Ø
for hard wires up to 1 mm Ø
pour fils durs à 1 mm Ø
para alambres duros hasta 1 mm Ø
per fili duri fino a 1 mm Ø

Drahtschneidezangen
Wire cutting forceps

Pinces coupantes
Alicates para cortar alambre
Pinze taglia filo



570 mm - 22½" **tk 38558-57**

für Kirschner Drähte und Steinmann Nägel bis 6 mm Ø
for Kirschner wires and Steinmann pins up to 6 mm Ø

pour des broches Kirschner et clous Steinmann à 6 mm Ø
para agujas de Kirschner y clavos de Steinmann hasta 6 mm Ø
per fili Kirschner e chiodi Steinmann fino a 6 mm Ø

1:3

Technische Zangen
Technical forceps

Pinces techniques
Pinzas tecnicas
Pinze tecniche



130 mm - 5"	tk 38562-13
180 mm - 7"	tk 38562-18



140 mm - 5½"	tk 38563-14
170 mm - 6¾"	tk 38563-17



	180 mm - 7"	180 mm - 7"
x = 5 mm	tk 38564-05	tk 38571-05 tucar
x = 7 mm	tk 38564-07	tk 38571-07 tucar

TUCAR

Technische Zangen
Technical forceps

Pinces techniques
Pinzas tecnicas
Pinze tecniche



185 mm - 7¼" **tk 38569-17**

Drahtbiegezange
Wire bending forceps

Pince à couder
Pinza para torcer
Pinza per piegare



185 mm - 7¼" **tk 38569-01**

Flachzange mit Seitenschneider, parallel-
fassend, für harte Drähte bis 1.6 mm Ø

Flat nose plier, parallel grip, incorporated
cutter, for hard wires up to 1.6 mm Ø

Pince à couder avec coupe latéral,
pour des fils durs à de 1.6 mm Ø
Pinza para torcer con corte lateral,
para alambres hasta 1.6 mm Ø

Pinza, morso piatto parallelo e taglia
fili laterale fino a 1.6 mm Ø



180 mm - 7" **tk 38573-18**

200 mm - 8" **tk 38573-20**

240 mm - 9½" **tk 38573-24**

Feststellzange
Locking plier

Pince à caler
Pinza de fijar
Pinza bloccante

Technische Zangen
Technical forceps

Pinces techniques
Pinzas tecnicas
Pinze tecniche



200 mm - 8" **tk38573-01**

Plattenbiegezange für Knochenplatten bis 2.7 mm Stärke
Plate bending plier for plates up to 2.7 mm

Pince à couder pour des plaques de 2.7 mm
Pinza para torcer, placas hasta 2.7 mm
Pinza piega placche fino a 2.7 mm

240 mm - 9½" **tk38573-02**

Plattenbiegezange für Knochenplatten bis 4 mm Stärke
Plate bending plier for plates up to 4 mm

Pince à cunder pour des plaques de 4 mm
Pinza para torcer, para placas hasta 4 mm
Pinza piega placche fino a 4 mm

Knochenhalteklammern – Knochenhaltezangen
Bone holding clamps – Bone holding forceps

Daviers à os – Daviers porte-os
Pinzas porta huesos – Pinzas para huesos
Tenaglie per ossa



1:2

GERSTER-LOWMANN

180 mm - 7"	x = 28 mm	tk 24696-18
200 mm - 8"	x = 35 mm	tk 24696-20
220 mm - 8 ³ / ₄ "	x = 40 mm	tk 24696-22

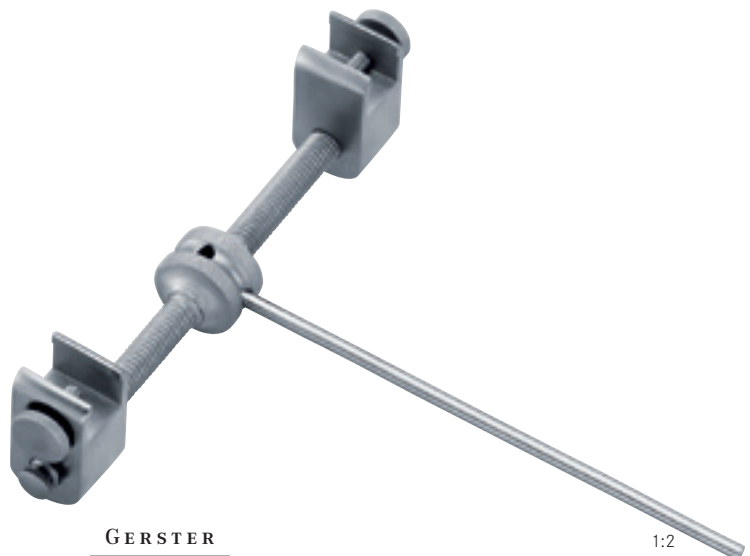

1:2

GERSTER

150 mm - 6"

tk 24698-00

Knochenhalteklammern – Knochenhaltezangen
Bone holding clamps – Bone holding forceps

Daviers à os – Daviers porte-os
Pinzas porta huesos – Pinzas para huesos
Tenaglie per ossa



FERGUSSON

210 mm - 8 1/4"

tk 24700-21

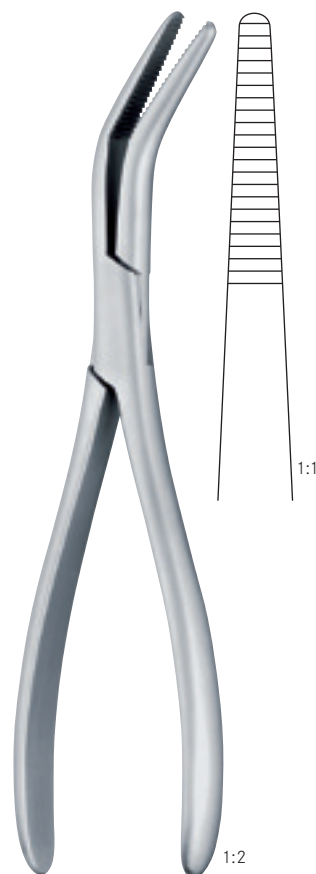

VAN BUREN

230 mm - 9"

tk 24701-23

Knochenhalte­zangen
Bone holding forceps

Daviers porte-os
Pinzas para huesos
Tenaglie per ossa



LANGENBECK

210 mm - 8 1/4"

tk 24702-21



SEMB

190 mm - 7 1/2"

tk 24704-19

Knochenhaltezangen
Bone holding forceps

Daviers porte-os
Pinzas para huesos
Tenaglie per ossa

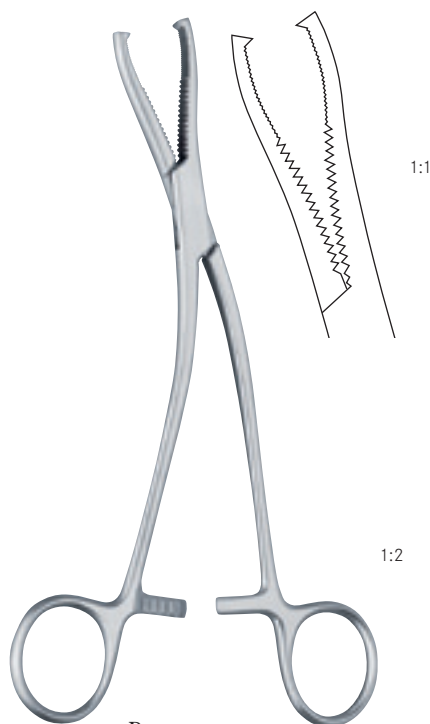

DINGMANN

190 mm - 7½"

tk 24705-19

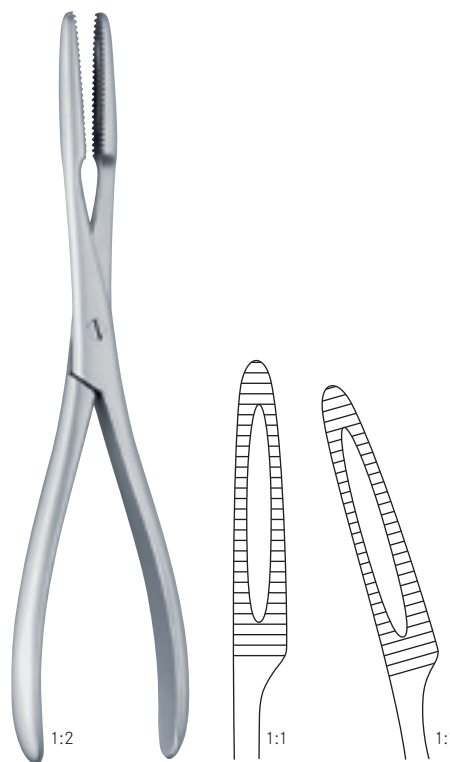

200 mm - 8"

tk 24706-20

tk 24707-20

Sequesterzange

Sequestrum forceps

Pince pour Sequestrum

Pinza para Sequestrum

Pinza per Sequestrum

Knochenhaltezangen
Bone holding forceps

Daviers porte-os
Pinzas para huesos
Tenaglie per ossa

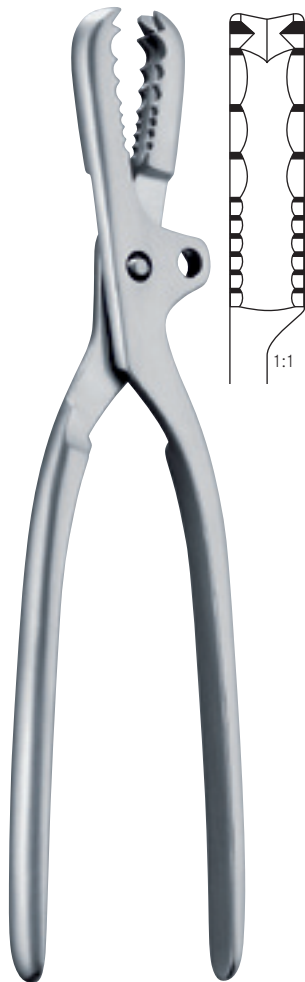

FARABEUF

230 mm - 9"	tk 24709-23
260 mm - 10 ¹ / ₄ "	tk 24709-26



FARABEUF-LAMBOTTE

260 mm - 10¹/₄"

tk 24710-26

Knochenhaltezangen
Bone holding forceps

Daviers porte-os
Pinzas para huesos
Tenaglie per ossa



MARTIN

190 mm - 7 1/2"

tk 24712-19



**BIRCHER-
GANSKE**

200 mm - 8"



1:1



1:1

tk 24713-20

tk 24714-20

Knochenhaltezangen
Bone holding forceps

Daviers porte-os
Pinzas para huesos
Tenaglie per ossa

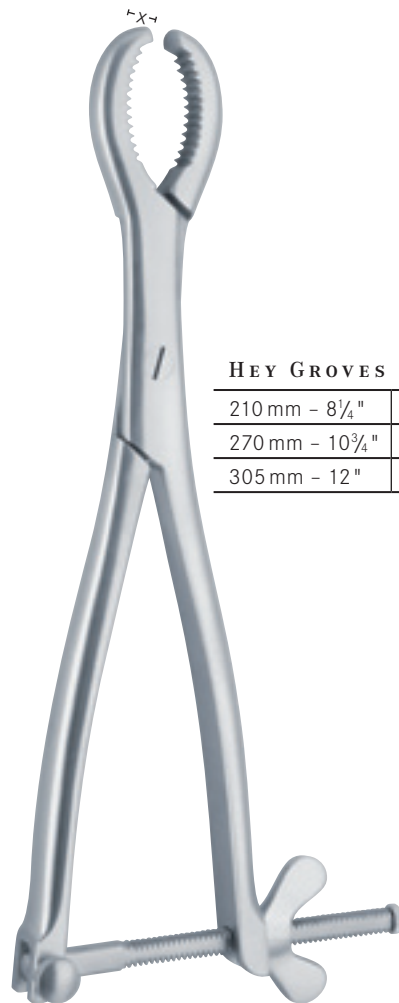

HEY GROVES

210 mm - 8 $\frac{1}{4}$ "	x = 6.5 mm	tk 24724-21
270 mm - 10 $\frac{3}{4}$ "	x = 7.5 mm	tk 24724-27
305 mm - 12"	x = 8.5 mm	tk 24724-30

Knochenhaltezangen
Bone holding forceps

Daviers porte-os
Pinzas para huesos
Tenaglie per ossa

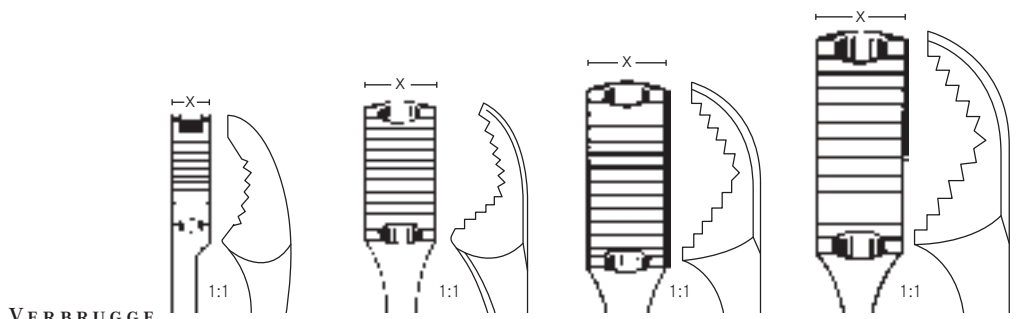

VERBRUGGE			
175 mm - 7"	250 mm - 10"	260 mm - 10¼"	270 mm - 10¾"
x = 5.0 mm	x = 9.5 mm	x = 10.5 mm	x = 12.0 mm
tk 24730-17	tk 24730-25	tk 24730-26	tk 24730-27

Knochenhalte­zangen
Bone holding forceps

Daviers porte-os
Pinzas para huesos
Tenaglie per ossa



KERN

170 mm - 6¾"	tk 24720-17	tk 24721-17
210 mm - 8¾"	tk 24720-21	tk 24721-21

Knochenhaltezangen
Bone holding forceps

Daviers porte-os
Pinzas para huesos
Tenaglie per ossa



LANE

330 mm - 13"	tk 24722-33	tk 24723-33
450 mm - 17 ³ / ₄ "	tk 24722-45	tk 24723-45

Knochenhaltezangen
Bone holding forceps

Daviers porte-os
Pinzas para huesos
Tenaglie per ossa



LAMBOTTE

220 mm - 8¾"	tk 24732-22
270 mm - 10¾"	tk 24732-27
300 mm - 12"	tk 24732-30

ein Maulteil beweglich
one jaw mobile

un mors mobile
una boca movable
una parte del morso mobile

150 mm - 6"	x = 2.5 mm	tk 24733-15
190 mm - 7½"	x = 6.5 mm	tk 24733-00
240 mm - 9½"	x = 9.5 mm	tk 24733-01
260 mm - 10¼"	x = 10.0 mm	tk 24733-02
280 mm - 11"	x = 11.0 mm	tk 24733-03

selbstzentrierend
self-centering

auto-centreur
autocentrante
autocentrante

Knochenhaltezangen
Bone holding forceps

Daviers porte-os
Pinzas para huesos
Tenaglie per ossa



ULRICH

230 mm - 9"	tk 24736-23	tk 24737-23
250 mm - 9¾"	tk 24736-25	tk 24737-25
280 mm - 11"	tk 24736-28	tk 24737-28

kniegebogen
angular
coudée
acodada
angolata



160 mm - 6¼"	tk 24738-16
240 mm - 9½"	tk 24738-24

Knochenhaltezangen – Repositionszangen
Bone holding forceps – Reposition forceps

Daviers porte-os – Pincas de reposition
Pinzas para huesos – Pinzas para reposición
Tenaglie per ossa – Pinze per riposizioni

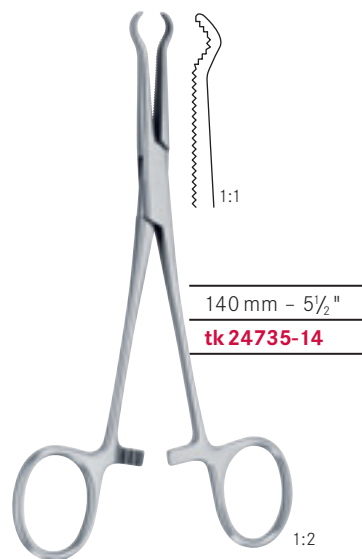
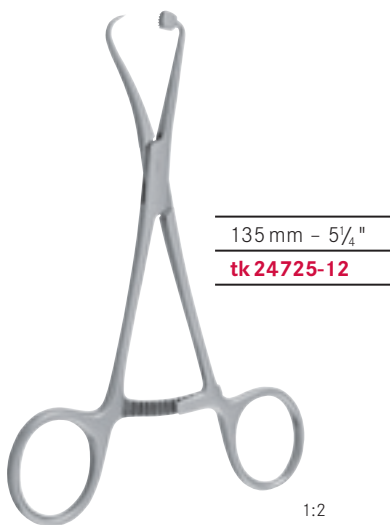

Knochenhaltezangen – Repositionszangen
Bone holding forceps – Reposition forceps

Daviers porte-os – Pincas de reposition
Pinzas para huesos – Pinzas para reposición
Tenaglie per ossa – Pinze per riposizione

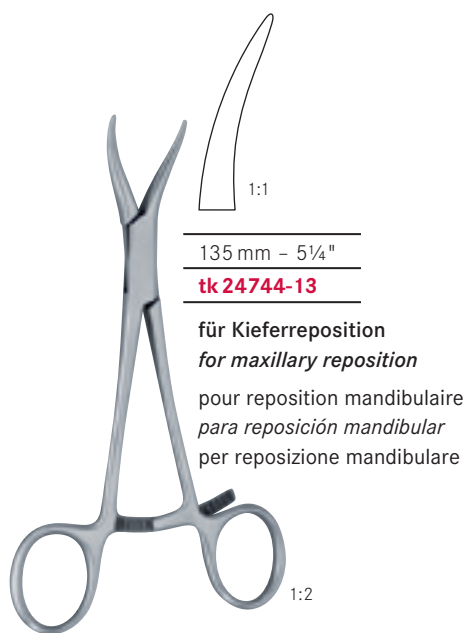
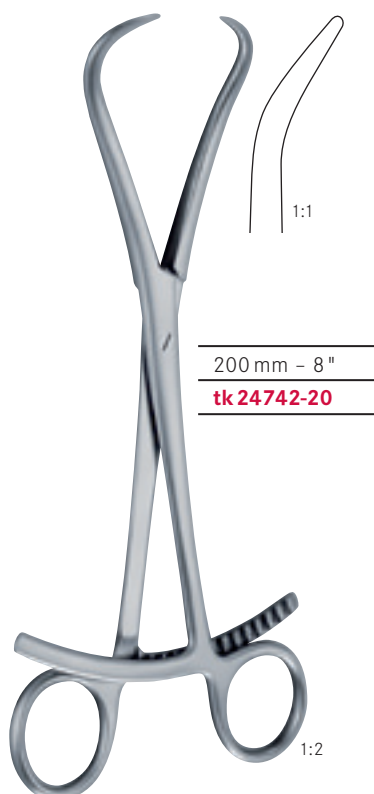

Repositionszangen
Reposition forceps

Pinces de reposition
Pinzas para reposición
Pinze per riposizione

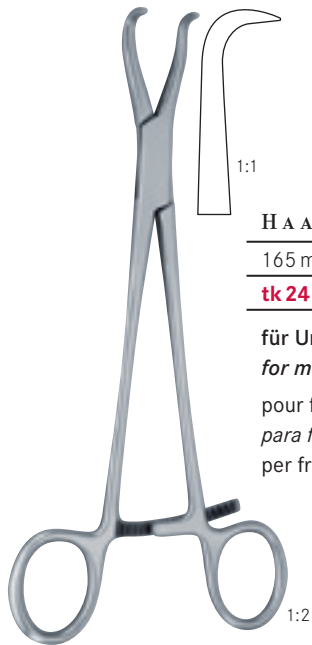

1:1

H A A S E

165 mm - 6½"

tk 24745-16

für Unterkieferfrakturen
for mandibular fractures
pour fractures mandibulaires
para fracturas del mandibulo
per fratture mandibulare

1:2

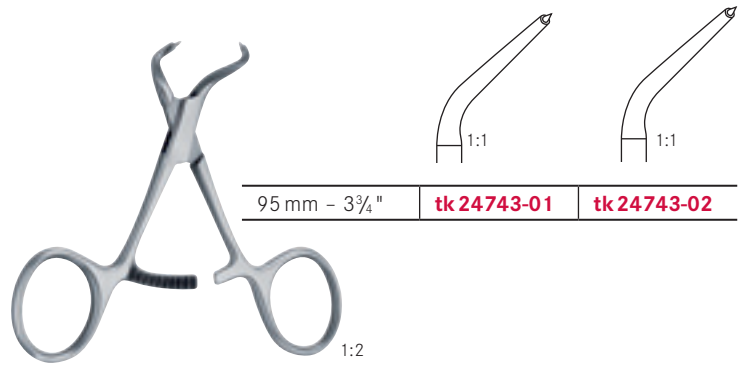

1:1

1:1

95 mm - 3¾"

tk 24743-01

tk 24743-02

1:2

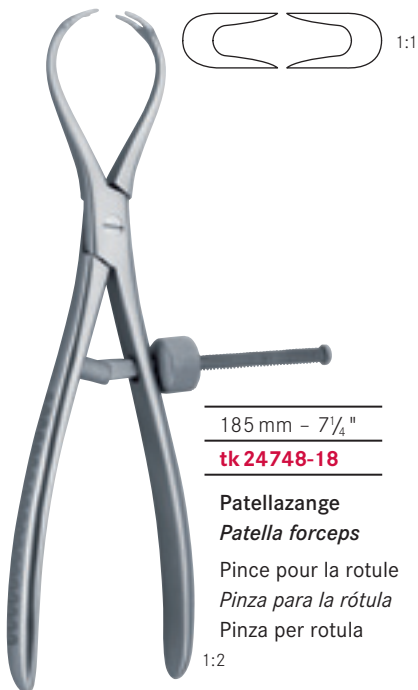

1:1

185 mm - 7¼"

tk 24748-18

Patellazange
Patella forceps
Pince pour la rotule
Pinza para la rótula
Pinza per rotula

1:2

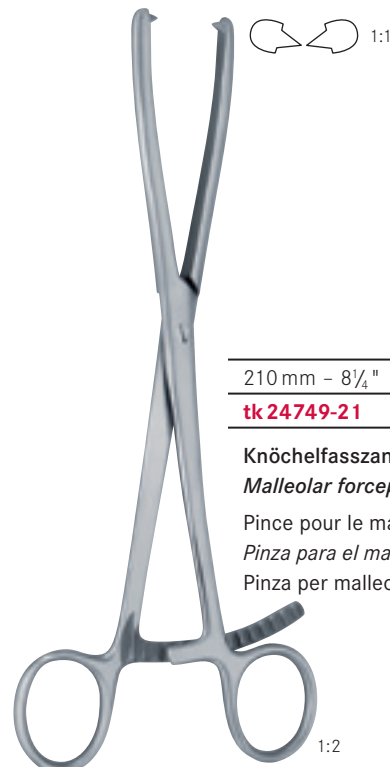

1:1

210 mm - 8¼"

tk 24749-21

Knöchelfasszange
Malleolar forceps
Pince pour le malléole
Pinza para el maleolo
Pinza per malleolo

1:2

Extensionsbügel
Extension bows

Etriers pour extension
Estribos para extensión
Archi per estensione



1:3

tk 38583-18 180 mm - 7"

Spannschlüssel für Kirschner Drähte
Wire strainer for Kirschner wires

Tendeur pour fils de Kirschner
Tensor para agujas de Kirschner
Chiave per estensione di fili Kirschner

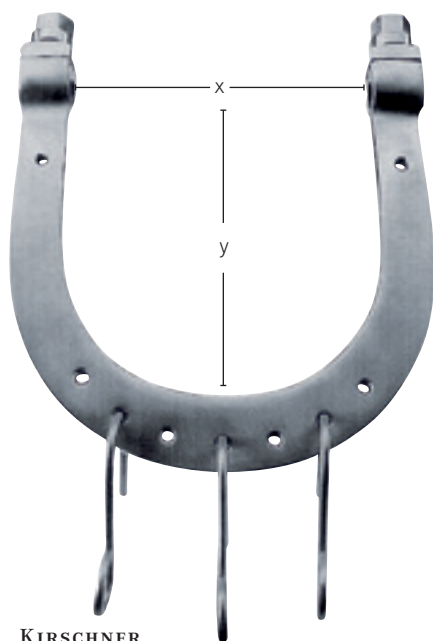

KIRSCHNER

x = 195 mm	y = 170 mm	tk 38580-01
x = 100 mm	y = 100 mm	tk 38580-02
x = 120 mm	y = 120 mm	tk 38580-03
x = 155 mm	y = 155 mm	tk 38580-04
x = 200 mm	y = 155 mm	tk 38580-05

mit 3 Zughaken

with 3 traction hooks

avec 3 crochets d'attelage
con 3 ganchos de tracción
con 3 ganci di trazione



KIRSCHNER

x = 130 mm	tk 38581-01
x = 185 mm	tk 38581-02
x = 220 mm	tk 38581-03

mit 3 Zughaken

with 3 traction hooks

avec 3 crochets d'attelage
con 3 ganchos de tracción
con 3 ganci di trazione

Extensionsbügel
Extension bows

Etriers pour extension
Estribos para extensión
Archi per estensione

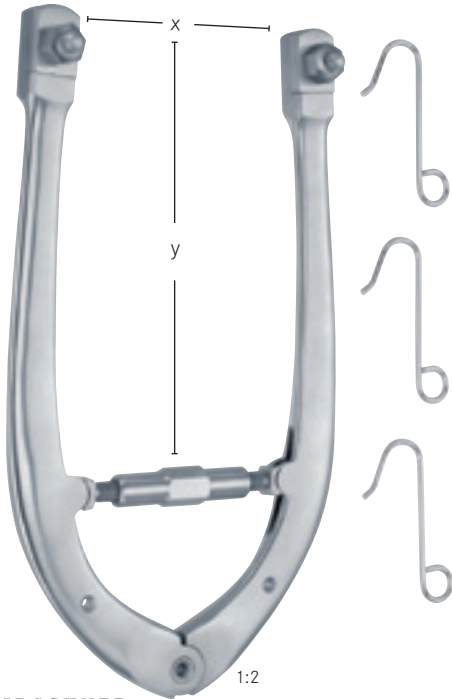

KIRSCHNER

x = 180 mm y = 100 mm

tk 38582-01

x = 270 mm y = 160 mm

tk 38582-02

mit 3 Zughaken

with 3 traction hooks

avec 3 crochets d'attelage

con 3 ganchos de tracción

con 3 ganci di trazione

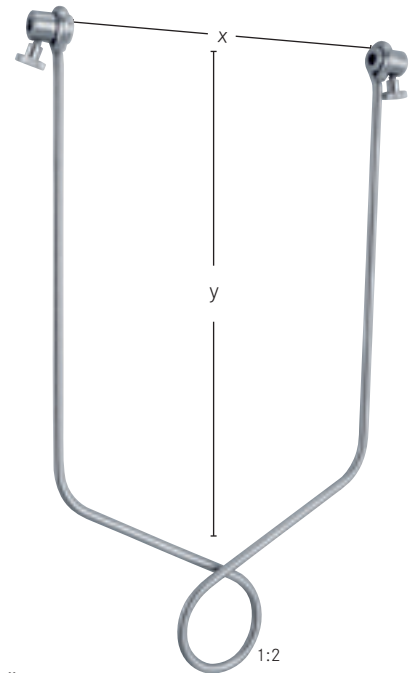

BÖHLER

x = 175 mm y = 190 mm

tk 38596-75

x = 190 mm y = 160 mm

tk 38597-90

x = 110 mm y = 210 mm

tk 38598-11

x = 150 mm y = 210 mm

tk 38598-21



	14 mm / 17 mm
190 mm - 7½"	tk 38584-19

Gabelschlüssel
Wrench

Clé de serrage

Llave de tuercas

Chiave per madreviti

Container und Zubehör
Containers and accessories

Contenaires et accessoires
Contenedores y accesorios
Container ed accessori

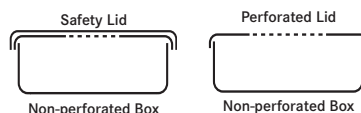

I / I		Safety Lid Non-perforated Box	Perforated Lid Non-perforated Box
580 x 280 x 100	■	tk 87170-1FS-SI	tk 87170-1F-SI
580 x 280 x 135	■	tk 87180-1FS-SI	tk 87180-1F-SI
580 x 280 x 150	■	tk 87190-1FS-SI	tk 87190-1F-SI
580 x 280 x 200	■	tk 87200-1FS-SI	tk 87200-1F-SI
580 x 280 x 260	■	tk 87210-1FS-SI	tk 87210-1F-SI
580 x 280 x 100	■	tk 87170-1FS-YE	tk 87170-1F-YE
580 x 280 x 135	■	tk 87180-1FS-YE	tk 87180-1F-YE
580 x 280 x 150	■	tk 87190-1FS-YE	tk 87190-1F-YE
580 x 280 x 200	■	tk 87200-1FS-YE	tk 87200-1F-YE
580 x 280 x 260	■	tk 87210-1FS-YE	tk 87210-1F-YE
580 x 280 x 100	■	tk 87170-1FS-GR	tk 87170-1F-GR
580 x 280 x 135	■	tk 87180-1FS-GR	tk 87180-1F-GR
580 x 280 x 150	■	tk 87190-1FS-GR	tk 87190-1F-GR
580 x 280 x 200	■	tk 87200-1FS-GR	tk 87200-1F-GR
580 x 280 x 260	■	tk 87210-1FS-GR	tk 87210-1F-GR
580 x 280 x 100	■	tk 87170-1FS-BL	tk 87170-1F-BL
580 x 280 x 135	■	tk 87180-1FS-BL	tk 87180-1F-BL
580 x 280 x 150	■	tk 87190-1FS-BL	tk 87190-1F-BL
580 x 280 x 200	■	tk 87200-1FS-BL	tk 87200-1F-BL
580 x 280 x 260	■	tk 87210-1FS-BL	tk 87210-1F-BL
580 x 280 x 100	■	tk 87170-1FS-RE	tk 87170-1F-RE
580 x 280 x 135	■	tk 87180-1FS-RE	tk 87180-1F-RE
580 x 280 x 150	■	tk 87190-1FS-RE	tk 87190-1F-RE
580 x 280 x 200	■	tk 87200-1FS-RE	tk 87200-1F-RE
580 x 280 x 260	■	tk 87210-1FS-RE	tk 87210-1F-RE
580 x 280 x 100	■	tk 87170-1FS-BK	tk 87170-1F-BK
580 x 280 x 135	■	tk 87180-1FS-BK	tk 87180-1F-BK
580 x 280 x 150	■	tk 87190-1FS-BK	tk 87190-1F-BK
580 x 280 x 200	■	tk 87200-1FS-BK	tk 87200-1F-BK
580 x 280 x 260	■	tk 87210-1FS-BK	tk 87210-1F-BK



480 x 250 x 30	tk 87014-01
480 x 250 x 50	tk 87014-02
480 x 250 x 70	tk 87014-03
480 x 250 x 100	tk 87014-04
540 x 250 x 30	tk 87015-01
540 x 250 x 50	tk 87015-02
540 x 250 x 70	tk 87015-03
540 x 250 x 100	tk 87015-04

Drahtkorb
Wire Basket

Paniers
Cestillos
Cestello

Container und Zubehör
Containers and accessories

Contenaires et accessoires
Contenedores y accesorios
Container ed accessori

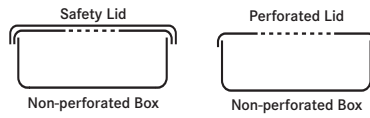

1 / 2

	Safety Lid	Perforated Lid
	Non-perforated Box	Non-perforated Box
285 x 280 x 100	tk 87100-1FS-SI	tk 87100-1F-SI
285 x 280 x 135	tk 87110-1FS-SI	tk 87110-1F-SI
285 x 280 x 150	tk 87120-1FS-SI	tk 87120-1F-SI
285 x 280 x 200	tk 87130-1FS-SI	tk 87130-1F-SI
285 x 280 x 260	tk 87136-1FS-SI	tk 87136-1F-SI
285 x 280 x 100	tk 87100-1FS-YE	tk 87100-1F-YE
285 x 280 x 135	tk 87110-1FS-YE	tk 87110-1F-YE
285 x 280 x 150	tk 87120-1FS-YE	tk 87120-1F-YE
285 x 280 x 200	tk 87130-1FS-YE	tk 87130-1F-YE
285 x 280 x 260	tk 87136-1FS-YE	tk 87136-1F-YE
285 x 280 x 100	tk 87100-1FS-GR	tk 87100-1F-GR
285 x 280 x 135	tk 87110-1FS-GR	tk 87110-1F-GR
285 x 280 x 150	tk 87120-1FS-GR	tk 87120-1F-GR
285 x 280 x 200	tk 87130-1FS-GR	tk 87130-1F-GR
285 x 280 x 260	tk 87136-1FS-GR	tk 87136-1F-GR
285 x 280 x 100	tk 87100-1FS-BL	tk 87100-1F-BL
285 x 280 x 135	tk 87110-1FS-BL	tk 87110-1F-BL
285 x 280 x 150	tk 87120-1FS-BL	tk 87120-1F-BL
285 x 280 x 200	tk 87130-1FS-BL	tk 87130-1F-BL
285 x 280 x 260	tk 87136-1FS-BL	tk 87136-1F-BL
285 x 280 x 100	tk 87100-1FS-RE	tk 87100-1F-RE
285 x 280 x 135	tk 87110-1FS-RE	tk 87110-1F-RE
285 x 280 x 150	tk 87120-1FS-RE	tk 87120-1F-RE
285 x 280 x 200	tk 87130-1FS-RE	tk 87130-1F-RE
285 x 280 x 260	tk 87136-1FS-RE	tk 87136-1F-RE
285 x 280 x 100	tk 87100-1FS-BK	tk 87100-1F-BK
285 x 280 x 135	tk 87110-1FS-BK	tk 87110-1F-BK
285 x 280 x 150	tk 87120-1FS-BK	tk 87120-1F-BK
285 x 280 x 200	tk 87130-1FS-BK	tk 87130-1F-BK
285 x 280 x 260	tk 87136-1FS-BK	tk 87136-1F-BK



250 x 250 x 30	tk 87010-01
250 x 250 x 50	tk 87010-02
250 x 250 x 70	tk 87010-03
250 x 250 x 100	tk 87010-04

Drahtkorb
Wire Basket

Paniers
Cestillos
Cestello

Zubehör | Accessoires
Accessories | Accessorios
Accessori



100 pcs. | **tk 87029-00**

Papieretikett für 1/1, 3/4, 1/2 Container
Paper label for 1/1, 3/4, 1/2 Container

Etiquette en papier pour containers 1/1, 3/4, 1/2
Etiquetas de papel para contenedores 1/1, 3/4, 1/2
Etichette in carta per container 1/1, 3/4, 1/2



100 pcs. | **tk 87028-00**

Sicherheitsplombe, Kunststoff
Security seal, plastic

Scellement de sécurité, plastique
Sello de seguridad, plastica
Sigillo di sicurita, plastica

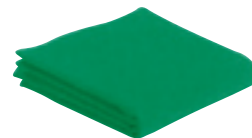

1300 x 600	tk 87026-07
1400 x 1000	tk 87026-08
1850 x 450	tk 87026-09
1850 x 600	tk 87026-10

Einschlagtuch
Drape
Drap
Tela
Telo



tk 87022-00

Dauerfilter für 1/1, 3/4, 1/2 Container
Permanent filter for 1/1, 3/4, 1/2 Container

Filtre permanent pour containers 1/1, 3/4, 1/2
Filtro permanente para contenedores 1/1, 3/4, 1/2
Filtro permanente per container 1/1, 3/4, 1/2



tk 87021-00

Mehrweg Textilfilter
Long term textile filter

Filtre en textile, réutilisable
Filtro de textil, reutilizable
Filtro in tessile, riutilizzabile



100 pcs. | **tk 87020-00**

Einweg Papierfilter
Single use paper filter

Filtre en papier
Fuiltro de papel
Filtro in carta

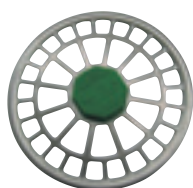

tk 87021-10

Filterhalter für 1/1, 3/4, 1/2 Container
Filter holder for 1/1, 3/4, 1/2 Container

Porte filtres pour containers 1/1, 3/4, 1/2
Porta filtros para contenedores 1/1, 3/4, 1/2
Porte filtri per container 1/1, 3/4, 1/2



tk 87021-15

Filter Spender
Filter dispenser

Magazin pour filtres
Caja para filtros
Distributore filtri



	tk 87025-04
	tk 87025-03
	tk 87025-02
	tk 87025-01
	tk 87025-00

Aluminium Plaketten, nach Wunsch graviert, max. 16 Stellen
Aluminium Plates, engraved upon request, max. 16 letters

Plaques en aluminium, gravées sur demande, max. 16 lettres
Placas den aluminio, grabadas según deseo, max 16 letras
Placche de alluminio, su richiesta, massimo 16 lettere

Nummernverzeichnis
Numerical Index
Index numériques
Indice numerico
Indice dei numeri d'articolo

Art. Nr.	Seite	Art. Nr.	Seite	Art. Nr.	Seite	Art. Nr.	Seite
tk 20801-15	148	tk 24738-24	167	tk 36250-90	22	tk 37471-40	26
tk 24054-01	20	tk 24740-14	108, 168	tk 36250-95	22	tk 37471-45	26
tk 24054-02	20	tk 24741-17	169	tk 36250-99	22	tk 37471-50	26
tk 24549-02	107	tk 24742-20	169	tk 36251-00	22	tk 37471-55	26
tk 24549-03	122	tk 24743-01	170	tk 36251-10	22	tk 37471-60	26
tk 24551-06	107	tk 24743-02	170	tk 36251-11	22	tk 37471-65	26
tk 24551-08	107	tk 24744-13	169	tk 36251-12	22	tk 37471-70	26
tk 24551-20	107	tk 24745-16	170	tk 36251-14	22	tk 37471-75	26
tk 24696-18	156	tk 24748-18	170	tk 36251-15	22	tk 37471-80	26
tk 24696-20	156	tk 24749-21	170	tk 36251-16	22	tk 37570-00	24
tk 24696-22	156	tk 36078-30	10	tk 36251-18	22	tk 37570-60	26
tk 24698-00	156	tk 36078-31	10	tk 36251-19	22	tk 37570-65	26
tk 24700-21	157	tk 36078-32	10	tk 36251-20	22	tk 37570-70	26
tk 24701-23	157	tk 36078-33	10	tk 36251-21	22	tk 37570-75	26
tk 24702-21	158	tk 36078-34	10	tk 36251-23	22	tk 37570-80	26
tk 24704-19	158	tk 36078-35	10	tk 36251-24	22	tk 37570-85	26
tk 24705-19	159	tk 36078-36	10	tk 36251-25	22	tk 37570-90	26
tk 24706-20	159	tk 36078-37	10	tk 36252-00	22	tk 37570-95	26
tk 24707-20	159	tk 36078-38	10	tk 36252-20	22	tk 37571-00	26
tk 24709-23	160	tk 36078-39	10	tk 36252-22	22	tk 37571-05	26
tk 24709-26	160	tk 36078-40	10	tk 36252-24	22	tk 37571-10	26
tk 24710-26	160	tk 36078-41	10	tk 36252-25	22	tk 37571-15	26
tk 24712-19	161	tk 36078-42	10	tk 36252-28	22	tk 37571-20	26
tk 24713-20	161	tk 36078-43	10	tk 36252-29	22	tk 37571-25	26
tk 24714-20	161	tk 36078-44	10	tk 36252-31	22	tk 37571-30	26
tk 24720-17	164	tk 36078-45	10	tk 36252-33	22	tk 37571-35	26
tk 24720-21	164	tk 36078-46	10	tk 36253-00	22	tk 37571-40	26
tk 24721-17	164	tk 36078-47	10	tk 36253-28	22	tk 37571-45	26
tk 24721-21	164	tk 36078-48	10	tk 36253-29	22	tk 37571-50	26
tk 24722-33	165	tk 36078-49	10	tk 36253-31	22	tk 37571-55	26
tk 24722-45	165	tk 36080-15	11	tk 36253-33	22	tk 37571-60	26
tk 24723-33	165	tk 36081-22	11	tk 36253-35	22	tk 37571-65	26
tk 24723-45	165	tk 36082-21	11, 23	tk 36253-37	22	tk 37571-70	26
tk 24724-21	162	tk 36083-20	12	tk 36253-39	22	tk 37571-75	26
tk 24724-27	162	tk 36084-40	12	tk 36253-41	22	tk 37571-80	26
tk 24724-30	162	tk 36250-00	22	tk 36260-01	23	tk 37580-06	27
tk 24725-12	168	tk 36250-10	22	tk 36260-02	23	tk 37580-07	27
tk 24726-17	168	tk 36250-11	22	tk 36260-03	23	tk 37580-08	27
tk 24730-17	163	tk 36250-12	22	tk 36260-04	23	tk 37580-09	27
tk 24730-25	163	tk 36250-14	22	tk 36265-01	23	tk 37580-10	27
tk 24730-26	163	tk 36250-15	22	tk 36265-02	23	tk 37580-11	27
tk 24730-27	163	tk 36250-16	22	tk 36265-03	23	tk 37580-12	27
tk 24732-22	166	tk 36250-18	22	tk 36265-04	23	tk 37580-13	27
tk 24732-27	166	tk 36250-19	22	tk 37470-60	26	tk 37580-14	27
tk 24732-30	166	tk 36250-20	22	tk 37470-65	26	tk 37580-15	27
tk 24733-00	166	tk 36250-21	22	tk 37470-70	26	tk 37580-16	27
tk 24733-01	166	tk 36250-23	22	tk 37470-75	26	tk 37580-17	27
tk 24733-02	166	tk 36250-24	22	tk 37470-80	26	tk 37580-18	27
tk 24733-03	166	tk 36250-25	22	tk 37470-85	26	tk 37580-19	27
tk 24733-15	108, 166	tk 36250-26	22	tk 37470-90	26	tk 37580-20	27
tk 24734-14	109, 169	tk 36250-30	22	tk 37470-95	26	tk 38110-35	19
tk 24735-14	168	tk 36250-40	22	tk 37471-00	26	tk 38112-08	11, 19
tk 24736-23	167	tk 36250-45	22	tk 37471-05	26	tk 38112-10	19
tk 24736-25	167	tk 36250-50	22	tk 37471-10	26	tk 38114-30	19, 21
tk 24736-28	167	tk 36250-60	22	tk 37471-15	26	tk 38114-35	19, 21
tk 24737-23	167	tk 36250-65	22	tk 37471-20	26	tk 38114-40	19, 21
tk 24737-25	167	tk 36250-70	22	tk 37471-25	26	tk 38114-50	19, 21
tk 24737-28	167	tk 36250-75	22	tk 37471-30	26	tk 38118-00	21
tk 24738-16	167	tk 36250-85	22	tk 37471-35	26	tk 38120-21	20

Nummernverzeichnis
Numerical Index

Index numériques
Indice numerico

Indice dei numeri d'articolo

Art. Nr.	Seite	Art. Nr.	Seite	Art. Nr.	Seite	Art. Nr.	Seite
tk 38122-06	20	tk 38204-36	16	tk 38210-14	17	tk 38214-44	17
tk 38122-09	20	tk 38204-38	16	tk 38210-16	17	tk 38214-46	17
tk 38122-13	20	tk 38204-40	16	tk 38210-18	17	tk 38214-48	17
tk 38125-30	21	tk 38204-42	16	tk 38210-20	17	tk 38214-50	17
tk 38200-14	16	tk 38204-44	16	tk 38210-22	17	tk 38214-52	17
tk 38200-16	16	tk 38204-46	16	tk 38210-24	17	tk 38215-32	17
tk 38200-18	16	tk 38204-48	16	tk 38210-26	17	tk 38215-34	17
tk 38200-20	16	tk 38204-50	16	tk 38210-28	17	tk 38215-36	17
tk 38200-22	16	tk 38204-52	16	tk 38210-30	17	tk 38215-38	17
tk 38200-24	16	tk 38205-32	16	tk 38210-32	17	tk 38215-40	17
tk 38200-26	16	tk 38205-34	16	tk 38210-34	17	tk 38215-42	17
tk 38200-28	16	tk 38205-36	16	tk 38210-36	17	tk 38215-44	17
tk 38200-30	16	tk 38205-38	16	tk 38211-14	17	tk 38215-46	17
tk 38200-32	16	tk 38205-40	16	tk 38211-16	17	tk 38215-48	17
tk 38200-34	16	tk 38205-42	16	tk 38211-18	17	tk 38215-50	17
tk 38200-36	16	tk 38205-44	16	tk 38211-20	17	tk 38215-52	17
tk 38201-14	16	tk 38205-46	16	tk 38211-22	17	tk 38216-34	17
tk 38201-16	16	tk 38205-48	16	tk 38211-24	17	tk 38216-36	17
tk 38201-18	16	tk 38205-50	16	tk 38211-26	17	tk 38216-38	17
tk 38201-20	16	tk 38205-52	16	tk 38211-28	17	tk 38216-40	17
tk 38201-22	16	tk 38206-34	16	tk 38211-30	17	tk 38216-42	17
tk 38201-24	16	tk 38206-36	16	tk 38211-32	17	tk 38216-44	17
tk 38201-26	16	tk 38206-38	16	tk 38211-34	17	tk 38216-46	17
tk 38201-28	16	tk 38206-40	16	tk 38211-36	17	tk 38216-48	17
tk 38201-30	16	tk 38206-42	16	tk 38211-38	17	tk 38216-50	17
tk 38201-32	16	tk 38206-44	16	tk 38211-40	17	tk 38216-52	17
tk 38201-34	16	tk 38206-46	16	tk 38212-24	17	tk 38217-34	17
tk 38201-36	16	tk 38206-48	16	tk 38212-26	17	tk 38217-36	17
tk 38201-38	16	tk 38206-50	16	tk 38212-28	17	tk 38217-38	17
tk 38201-40	16	tk 38206-52	16	tk 38212-30	17	tk 38217-40	17
tk 38202-24	16	tk 38207-34	16	tk 38212-32	17	tk 38217-42	17
tk 38202-26	16	tk 38207-36	16	tk 38212-34	17	tk 38217-44	17
tk 38202-28	16	tk 38207-38	16	tk 38212-36	17	tk 38217-46	17
tk 38202-30	16	tk 38207-40	16	tk 38212-38	17	tk 38217-48	17
tk 38202-32	16	tk 38207-42	16	tk 38212-40	17	tk 38217-50	17
tk 38202-34	16	tk 38207-44	16	tk 38212-42	17	tk 38217-52	17
tk 38202-36	16	tk 38207-46	16	tk 38212-44	17	tk 38218-34	17
tk 38202-38	16	tk 38207-48	16	tk 38212-46	17	tk 38218-36	17
tk 38202-40	16	tk 38207-50	16	tk 38212-48	17	tk 38218-38	17
tk 38202-42	16	tk 38207-52	16	tk 38212-50	17	tk 38218-40	17
tk 38202-44	16	tk 38208-34	16	tk 38212-52	17	tk 38218-42	17
tk 38202-46	16	tk 38208-36	16	tk 38213-30	17	tk 38218-44	17
tk 38202-48	16	tk 38208-38	16	tk 38213-32	17	tk 38218-46	17
tk 38202-50	16	tk 38208-40	16	tk 38213-34	17	tk 38218-48	17
tk 38202-52	16	tk 38208-42	16	tk 38213-36	17	tk 38218-50	17
tk 38203-30	16	tk 38208-44	16	tk 38213-38	17	tk 38218-52	17
tk 38203-32	16	tk 38208-46	16	tk 38213-40	17	tk 38219-36	17
tk 38203-34	16	tk 38208-48	16	tk 38213-42	17	tk 38219-38	17
tk 38203-36	16	tk 38208-50	16	tk 38213-44	17	tk 38219-40	17
tk 38203-38	16	tk 38208-52	16	tk 38213-46	17	tk 38219-42	17
tk 38203-40	16	tk 38209-36	16	tk 38213-48	17	tk 38219-44	17
tk 38203-42	16	tk 38209-38	16	tk 38213-50	17	tk 38219-46	17
tk 38203-44	16	tk 38209-40	16	tk 38213-52	17	tk 38219-48	17
tk 38203-46	16	tk 38209-42	16	tk 38214-32	17	tk 38219-50	17
tk 38203-48	16	tk 38209-44	16	tk 38214-34	17	tk 38219-52	17
tk 38203-50	16	tk 38209-46	16	tk 38214-36	17	tk 38220-18	18
tk 38203-52	16	tk 38209-48	16	tk 38214-38	17	tk 38220-19	18
tk 38204-32	16	tk 38209-50	16	tk 38214-40	17	tk 38220-20	18
tk 38204-34	16	tk 38209-52	16	tk 38214-42	17	tk 38220-21	18

Nummernverzeichnis
Numerical Index
Index numériques
Indice numerico
Indice dei numeri d'articolo

Art. Nr.	Seite	Art. Nr.	Seite	Art. Nr.	Seite	Art. Nr.	Seite
tk 38220-22	18	tk 38223-22	18	tk 38225-35	18	tk 38228-37	18
tk 38220-23	18	tk 38223-23	18	tk 38225-36	18	tk 38228-38	18
tk 38220-24	18	tk 38223-24	18	tk 38225-37	18	tk 38228-39	18
tk 38220-25	18	tk 38223-25	18	tk 38225-38	18	tk 38228-40	18
tk 38220-26	18	tk 38223-26	18	tk 38225-39	18	tk 38229-00	17
tk 38220-27	18	tk 38223-27	18	tk 38225-40	18	tk 38240-10	132
tk 38220-28	18	tk 38223-28	18	tk 38226-18	18	tk 38240-12	132
tk 38220-29	18	tk 38223-29	18	tk 38226-19	18	tk 38240-14	132
tk 38220-30	18	tk 38223-30	18	tk 38226-20	18	tk 38240-16	132
tk 38221-18	18	tk 38223-31	18	tk 38226-21	18	tk 38240-18	132
tk 38221-19	18	tk 38223-32	18	tk 38226-22	18	tk 38240-20	132
tk 38221-20	18	tk 38223-33	18	tk 38226-23	18	tk 38240-22	132
tk 38221-21	18	tk 38223-34	18	tk 38226-24	18	tk 38240-24	132
tk 38221-22	18	tk 38223-35	18	tk 38226-25	18	tk 38240-26	132
tk 38221-23	18	tk 38223-36	18	tk 38226-26	18	tk 38240-28	132
tk 38221-24	18	tk 38223-37	18	tk 38226-27	18	tk 38240-30	132
tk 38221-25	18	tk 38223-38	18	tk 38226-28	18	tk 38240-32	132
tk 38221-26	18	tk 38223-39	18	tk 38226-29	18	tk 38240-34	132
tk 38221-27	18	tk 38223-40	18	tk 38226-30	18	tk 38240-36	132
tk 38221-28	18	tk 38224-18	18	tk 38226-31	18	tk 38240-38	132
tk 38221-29	18	tk 38224-19	18	tk 38226-32	18	tk 38240-40	132
tk 38221-30	18	tk 38224-20	18	tk 38226-33	18	tk 38240-42	132
tk 38221-31	18	tk 38224-21	18	tk 38226-34	18	tk 38240-44	132
tk 38221-32	18	tk 38224-22	18	tk 38226-35	18	tk 38240-46	132
tk 38221-33	18	tk 38224-23	18	tk 38226-36	18	tk 38240-48	132
tk 38221-34	18	tk 38224-24	18	tk 38226-37	18	tk 38240-50	132
tk 38221-35	18	tk 38224-25	18	tk 38226-38	18	tk 38242-20	132
tk 38221-36	18	tk 38224-26	18	tk 38226-39	18	tk 38242-22	132
tk 38221-37	18	tk 38224-27	18	tk 38226-40	18	tk 38242-24	132
tk 38221-38	18	tk 38224-28	18	tk 38227-18	18	tk 38242-26	132
tk 38221-39	18	tk 38224-29	18	tk 38227-19	18	tk 38242-28	132
tk 38221-40	18	tk 38224-30	18	tk 38227-20	18	tk 38242-30	132
tk 38222-18	18	tk 38224-31	18	tk 38227-21	18	tk 38242-32	132
tk 38222-19	18	tk 38224-32	18	tk 38227-22	18	tk 38242-34	132
tk 38222-20	18	tk 38224-33	18	tk 38227-23	18	tk 38242-36	132
tk 38222-21	18	tk 38224-34	18	tk 38227-24	18	tk 38242-38	132
tk 38222-22	18	tk 38224-35	18	tk 38227-25	18	tk 38242-40	132
tk 38222-23	18	tk 38224-36	18	tk 38227-26	18	tk 38242-42	132
tk 38222-24	18	tk 38224-37	18	tk 38227-27	18	tk 38242-44	132
tk 38222-25	18	tk 38224-38	18	tk 38227-28	18	tk 38242-46	132
tk 38222-26	18	tk 38224-39	18	tk 38227-29	18	tk 38242-48	132
tk 38222-27	18	tk 38224-40	18	tk 38227-30	18	tk 38242-50	132
tk 38222-28	18	tk 38225-18	18	tk 38227-31	18	tk 38242-52	132
tk 38222-29	18	tk 38225-19	18	tk 38227-32	18	tk 38242-54	132
tk 38222-30	18	tk 38225-20	18	tk 38227-33	18	tk 38242-56	132
tk 38222-31	18	tk 38225-21	18	tk 38227-34	18	tk 38242-58	132
tk 38222-32	18	tk 38225-22	18	tk 38227-35	18	tk 38242-60	132
tk 38222-33	18	tk 38225-23	18	tk 38227-36	18	tk 38244-10	132
tk 38222-34	18	tk 38225-24	18	tk 38227-37	18	tk 38244-12	132
tk 38222-35	18	tk 38225-25	18	tk 38227-38	18	tk 38244-14	132
tk 38222-36	18	tk 38225-26	18	tk 38227-39	18	tk 38244-16	132
tk 38222-37	18	tk 38225-27	18	tk 38227-40	18	tk 38244-18	132
tk 38222-38	18	tk 38225-28	18	tk 38228-30	18	tk 38244-20	132
tk 38222-39	18	tk 38225-29	18	tk 38228-31	18	tk 38244-22	132
tk 38222-40	18	tk 38225-30	18	tk 38228-32	18	tk 38244-24	132
tk 38223-18	18	tk 38225-31	18	tk 38228-33	18	tk 38244-26	132
tk 38223-19	18	tk 38225-32	18	tk 38228-34	18	tk 38244-28	132
tk 38223-20	18	tk 38225-33	18	tk 38228-35	18	tk 38244-30	132
tk 38223-21	18	tk 38225-34	18	tk 38228-36	18	tk 38244-32	132

Nummernverzeichnis
Numerical Index

Index numériques
Indice numerico
Indice dei numeri d'articolo

Art. Nr.	Seite	Art. Nr.	Seite	Art. Nr.	Seite	Art. Nr.	Seite
tk 38244-34	132	tk 38292-01	32	tk 38295-95	30	tk 38310-10	38
tk 38244-36	132	tk 38292-02	32	tk 38296-102	30	tk 38310-12	38
tk 38244-38	132	tk 38292-03	32	tk 38296-108	30	tk 38310-14	38
tk 38244-40	132	tk 38292-04	32	tk 38296-114	30	tk 38310-16	38
tk 38244-42	132	tk 38292-05	32	tk 38296-121	30	tk 38310-18	38
tk 38244-44	132	tk 38292-06	32	tk 38296-57	30	tk 38310-20	38
tk 38244-46	132	tk 38292-07	32	tk 38296-63	30	tk 38310-22	38
tk 38244-48	132	tk 38292-08	32	tk 38296-70	30	tk 38312-00	37
tk 38244-50	132	tk 38292-09	32	tk 38296-76	30	tk 38312-05	37
tk 38246-20	132	tk 38292-10	32	tk 38296-82	30	tk 38312-10	37
tk 38246-22	132	tk 38292-102	30	tk 38296-89	30	tk 38312-15	37
tk 38246-24	132	tk 38292-108	30	tk 38296-95	30	tk 38312-20	37
tk 38246-26	132	tk 38292-11	32	tk 38297-00	40	tk 38312-25	37
tk 38246-28	132	tk 38292-114	30	tk 38297-23	42	tk 38312-30	37
tk 38246-30	132	tk 38292-12	32	tk 38297-50	42	tk 38312-35	37
tk 38246-32	132	tk 38292-121	30	tk 38297-55	42	tk 38312-40	37
tk 38246-34	132	tk 38292-13	32	tk 38297-60	42	tk 38312-45	37
tk 38246-36	132	tk 38292-14	32	tk 38298-00	42	tk 38312-50	37, 39
tk 38246-38	132	tk 38292-15	32	tk 38299-00	43	tk 38312-55	37, 39
tk 38246-40	132	tk 38292-16	32	tk 38300-00	43	tk 38312-60	37, 39
tk 38246-42	132	tk 38292-57	30	tk 38300-01	43	tk 38312-65	37, 39
tk 38246-44	132	tk 38292-63	30	tk 38300-10	44	tk 38312-70	37, 39
tk 38246-46	132	tk 38292-70	30	tk 38300-20	44	tk 38312-75	37, 39
tk 38246-48	132	tk 38292-76	30	tk 38300-30	44	tk 38312-80	37, 39
tk 38246-50	132	tk 38292-82	30	tk 38300-35	62	tk 38312-85	37, 39
tk 38246-52	132	tk 38292-89	30	tk 38300-40	45	tk 38312-90	37
tk 38246-54	132	tk 38292-95	30	tk 38300-50	45	tk 38312-95	37
tk 38246-56	132	tk 38293-102	30	tk 38301-00	45	tk 38313-00	37
tk 38246-58	132	tk 38293-108	30	tk 38304-04	36	tk 38317-01	51
tk 38246-60	132	tk 38293-114	30	tk 38304-05	36	tk 38317-02	51
tk 38250-00	29, 31	tk 38293-121	30	tk 38304-06	36	tk 38317-03	51
tk 38252-00	29, 31	tk 38293-57	30	tk 38305-04	36	tk 38317-04	52
tk 38254-00	29, 31	tk 38293-63	30	tk 38305-05	36	tk 38317-05	52
tk 38256-00	29	tk 38293-70	30	tk 38305-06	36	tk 38317-06	52
tk 38260-60	28	tk 38293-76	30	tk 38306-02	36	tk 38317-10	38
tk 38260-65	28	tk 38293-82	30	tk 38306-04	36	tk 38317-12	39
tk 38260-70	28	tk 38293-89	30	tk 38306-05	36	tk 38317-14	39
tk 38260-75	28	tk 38293-95	30	tk 38306-06	36	tk 38317-16	39
tk 38260-80	28	tk 38294-102	30	tk 38306-08	36	tk 38317-18	39
tk 38260-85	28	tk 38294-108	30	tk 38306-10	36	tk 38317-27	135
tk 38260-90	28	tk 38294-114	30	tk 38306-12	36	tk 38317-45	135
tk 38260-95	28	tk 38294-121	30	tk 38306-14	36	tk 38318-10	53
tk 38261-00	28	tk 38294-57	30	tk 38306-16	36	tk 38318-20	53
tk 38261-05	28	tk 38294-63	30	tk 38307-04	36	tk 38318-30	53
tk 38261-10	28	tk 38294-70	30	tk 38307-05	36	tk 38319-01	54
tk 38261-15	28	tk 38294-76	30	tk 38307-06	36	tk 38319-02	54
tk 38261-20	28	tk 38294-82	30	tk 38308-04	36	tk 38319-03	54
tk 38261-25	28	tk 38294-89	30	tk 38308-05	36	tk 38319-04	54
tk 38261-30	28	tk 38294-95	30	tk 38308-06	36	tk 38319-05	54
tk 38261-35	28	tk 38295-102	30	tk 38309-02	36	tk 38319-20	62
tk 38261-40	28	tk 38295-108	30	tk 38309-04	36	tk 38319-25	65
tk 38261-45	28	tk 38295-114	30	tk 38309-05	36	tk 38319-26	65
tk 38261-50	28	tk 38295-121	30	tk 38309-06	36	tk 38320-50	48
tk 38265-03	28	tk 38295-57	30	tk 38309-08	36	tk 38320-60	48
tk 38265-05	28	tk 38295-63	30	tk 38309-10	36	tk 38320-70	48
tk 38265-07	28	tk 38295-70	30	tk 38309-12	36	tk 38320-75	48
tk 38265-12	28	tk 38295-76	30	tk 38310-00	36	tk 38320-80	48
tk 38266-00	28	tk 38295-82	30	tk 38310-06	38	tk 38320-85	48
tk 38292-00	32	tk 38295-89	30	tk 38310-08	38	tk 38320-90	48

Nummernverzeichnis
Numerical Index
Index numériques
Indice numerico
Indice dei numeri d'articolo

Art. Nr.	Seite	Art. Nr.	Seite	Art. Nr.	Seite	Art. Nr.	Seite
tk 38320-95	48	tk 38335-78	84	tk 38344-12	78	tk 38362-05	81
tk 38321-00	48	tk 38335-79	84	tk 38344-13	78	tk 38362-06	81
tk 38321-05	48	tk 38335-80	84	tk 38344-14	78	tk 38363-04	82
tk 38323-50	48	tk 38335-82	84	tk 38344-15	78	tk 38363-06	82
tk 38323-60	48	tk 38335-84	84	tk 38344-16	78	tk 38363-08	82
tk 38323-70	48	tk 38336-02	79	tk 38344-17	78	tk 38364-04	82
tk 38323-80	48	tk 38336-03	79	tk 38344-18	78	tk 38364-06	82
tk 38323-90	48	tk 38336-04	79	tk 38348-04	93	tk 38364-08	82
tk 38326-70	48	tk 38336-05	79	tk 38348-05	93	tk 38365-07	85
tk 38326-80	48	tk 38336-06	79	tk 38348-06	93	tk 38365-09	85
tk 38326-90	48	tk 38336-07	79	tk 38348-07	93	tk 38365-11	85
tk 38328-70	48	tk 38336-08	79	tk 38348-08	93	tk 38365-13	85
tk 38328-80	48	tk 38336-09	79	tk 38348-09	93	tk 38366-07	85
tk 38328-90	48	tk 38336-10	79	tk 38348-10	93	tk 38366-09	85
tk 38329-00	49	tk 38336-11	79	tk 38348-11	93	tk 38366-11	85
tk 38329-05	49	tk 38336-12	79	tk 38348-12	93	tk 38366-13	85
tk 38329-10	49	tk 38336-13	79	tk 38355-03	117	tk 38367-07	85
tk 38329-70	49	tk 38336-14	79	tk 38355-04	117	tk 38367-09	85
tk 38329-75	49	tk 38336-15	79	tk 38355-05	117	tk 38367-11	85
tk 38329-80	49	tk 38336-16	79	tk 38355-06	117	tk 38367-13	85
tk 38329-85	49	tk 38336-30	84	tk 38355-07	117	tk 38368-07	85
tk 38329-90	49	tk 38336-40	84	tk 38355-08	117	tk 38368-09	85
tk 38329-95	49	tk 38336-50	84	tk 38357-02	95	tk 38368-11	85
tk 38330-50	50	tk 38336-60	84	tk 38357-03	95	tk 38368-13	85
tk 38330-60	50	tk 38336-70	84	tk 38357-04	95	tk 38370-07	86
tk 38330-70	50	tk 38336-80	84	tk 38357-05	95	tk 38370-09	86
tk 38330-80	50	tk 38337-02	116	tk 38357-06	95	tk 38370-11	86
tk 38331-50	50	tk 38337-04	116	tk 38357-07	95	tk 38370-13	86
tk 38331-60	50	tk 38337-05	116	tk 38357-08	95	tk 38371-07	86
tk 38331-70	50	tk 38337-06	116	tk 38357-09	95	tk 38371-09	86
tk 38331-80	50	tk 38337-07	116	tk 38357-10	95	tk 38371-11	86
tk 38332-50	50	tk 38337-08	116	tk 38357-12	95	tk 38371-13	86
tk 38332-60	50	tk 38337-09	116	tk 38359-02	80	tk 38372-07	86
tk 38332-70	50	tk 38337-10	116	tk 38359-03	80	tk 38372-09	86
tk 38332-80	50	tk 38337-12	116	tk 38359-04	80	tk 38372-11	86
tk 38333-50	50	tk 38339-04	116	tk 38359-05	80	tk 38372-13	86
tk 38333-60	50	tk 38339-05	116	tk 38359-06	80	tk 38373-07	86
tk 38333-70	50	tk 38339-06	116	tk 38359-07	80	tk 38373-09	86
tk 38333-80	50	tk 38339-07	116	tk 38359-08	80	tk 38373-11	86
tk 38335-02	79	tk 38339-08	116	tk 38359-09	80	tk 38373-13	86
tk 38335-03	79	tk 38343-02	78	tk 38359-10	80	tk 38375-02	94
tk 38335-04	79	tk 38343-03	78	tk 38359-11	80	tk 38375-03	94
tk 38335-05	79	tk 38343-04	78	tk 38359-12	80	tk 38375-04	94
tk 38335-06	79	tk 38343-05	78	tk 38360-02	118	tk 38375-05	94
tk 38335-07	79	tk 38343-06	78	tk 38360-03	118	tk 38375-06	94
tk 38335-08	79	tk 38343-07	78	tk 38360-12	118	tk 38375-07	94
tk 38335-09	79	tk 38343-08	78	tk 38360-13	118	tk 38375-08	94
tk 38335-10	79	tk 38343-09	78	tk 38360-22	118	tk 38375-09	94
tk 38335-11	79	tk 38343-10	78	tk 38360-33	118	tk 38375-10	94
tk 38335-12	79	tk 38343-11	78	tk 38360-53	118	tk 38375-12	94
tk 38335-13	79	tk 38343-12	78	tk 38360-54	118	tk 38376-03	96
tk 38335-14	79	tk 38343-14	78	tk 38360-55	118	tk 38376-05	96
tk 38335-30	84	tk 38343-16	78	tk 38360-56	118	tk 38378-04	96
tk 38335-40	84	tk 38344-06	78	tk 38361-03	81	tk 38378-06	96
tk 38335-50	84	tk 38344-07	78	tk 38361-04	81	tk 38378-33	97
tk 38335-60	84	tk 38344-08	78	tk 38361-05	81	tk 38378-43	97
tk 38335-72	84	tk 38344-09	78	tk 38361-06	81	tk 38378-53	97
tk 38335-74	84	tk 38344-10	78	tk 38361-08	81	tk 38379-08	88
tk 38335-76	84	tk 38344-11	78	tk 38362-04	81	tk 38379-09	88

Nummernverzeichnis
Numerical Index

Index numériques

Indice numerico

Indice dei numeri d'articolo

Art. Nr.	Seite	Art. Nr.	Seite	Art. Nr.	Seite	Art. Nr.	Seite
tk 38379-10	88	tk 38389-20	129	tk 38401-14	119	tk 38407-28	100
tk 38379-11	88	tk 38390-66	99	tk 38401-16	119	tk 38407-30	100
tk 38380-03	97	tk 38390-68	99	tk 38401-18	119	tk 38407-32	100
tk 38380-04	97	tk 38390-70	99	tk 38401-20	119	tk 38407-34	100
tk 38380-15	83	tk 38390-72	99	tk 38402-06	120	tk 38407-36	100
tk 38380-16	83	tk 38390-74	99	tk 38402-08	120	tk 38407-38	100
tk 38381-07	87	tk 38390-76	99	tk 38402-10	120	tk 38407-40	100
tk 38381-09	87	tk 38390-78	99	tk 38402-12	120	tk 38407-45	100
tk 38381-11	87	tk 38390-80	99	tk 38402-14	120	tk 38407-50	100
tk 38381-13	87	tk 38390-82	99	tk 38402-16	120	tk 38407-55	100
tk 38381-15	87	tk 38390-84	99	tk 38402-18	120	tk 38407-60	100
tk 38382-07	87	tk 38391-01	123	tk 38402-20	120	tk 38407-65	100
tk 38382-09	87	tk 38391-02	103	tk 38402-22	120	tk 38407-70	100
tk 38382-11	87	tk 38391-03	103	tk 38402-24	120	tk 38407-75	100
tk 38382-13	87	tk 38391-04	60, 124	tk 38402-26	120	tk 38407-80	100
tk 38382-15	87	tk 38391-05	60	tk 38402-28	120	tk 38408-10	100
tk 38383-05	87	tk 38391-06	61	tk 38402-30	120	tk 38408-12	100
tk 38383-07	87	tk 38391-08	123	tk 38402-32	120	tk 38408-14	100
tk 38383-09	87	tk 38391-10	60	tk 38402-34	120	tk 38408-16	100
tk 38383-11	87	tk 38391-11	103	tk 38402-36	120	tk 38408-18	100
tk 38383-13	87	tk 38391-12	134	tk 38402-38	120	tk 38408-20	100
tk 38384-05	87	tk 38392-00	61	tk 38402-40	120	tk 38408-22	100
tk 38384-07	87	tk 38392-01	61	tk 38403-06	119	tk 38408-24	100
tk 38384-09	87	tk 38392-02	61, 103	tk 38403-08	119	tk 38408-26	100
tk 38384-11	87	tk 38392-03	61	tk 38403-10	119	tk 38408-28	100
tk 38384-13	87	tk 38392-27	61	tk 38403-12	119	tk 38408-30	100
tk 38386-03	98	tk 38392-35	61, 105	tk 38403-14	119	tk 38408-32	100
tk 38386-04	98	tk 38392-35	61	tk 38403-16	119	tk 38408-34	100
tk 38386-05	98	tk 38392-45	61	tk 38403-18	119	tk 38408-36	100
tk 38386-06	98	tk 38394-15	110	tk 38403-20	119	tk 38408-38	100
tk 38386-07	98	tk 38394-24	64	tk 38403-22	119	tk 38408-40	100
tk 38386-08	98	tk 38394-27	110	tk 38403-24	119	tk 38408-45	100
tk 38386-09	98	tk 38394-35	110	tk 38405-06	119	tk 38408-50	100
tk 38386-10	98	tk 38395-00	64	tk 38405-08	119	tk 38408-55	100
tk 38386-11	98	tk 38397-01	63, 123	tk 38405-10	119	tk 38408-60	100
tk 38386-12	98	tk 38397-02	63, 109, 123	tk 38405-12	119	tk 38409-10	100
tk 38386-13	98	tk 38397-03	63	tk 38405-14	119	tk 38409-12	100
tk 38386-14	98	tk 38397-09	136	tk 38405-16	119	tk 38409-14	100
tk 38386-15	98	tk 38397-10	138	tk 38405-18	119	tk 38409-16	100
tk 38386-16	98	tk 38397-11	136	tk 38405-20	119	tk 38409-18	100
tk 38386-18	98	tk 38397-12	130	tk 38405-22	119	tk 38409-20	100
tk 38386-20	98	tk 38398-15	63, 109	tk 38405-24	119	tk 38409-22	100
tk 38386-22	98		124, 136	tk 38405-26	119	tk 38409-24	100
tk 38387-06	98	tk 38399-08	63, 109, 136	tk 38405-28	119	tk 38409-26	100
tk 38387-08	98	tk 38399-10	130, 137	tk 38405-30	119	tk 38409-28	100
tk 38387-10	98	tk 38399-16	137	tk 38405-32	119	tk 38409-30	100
tk 38387-12	98	tk 38399-17	137	tk 38405-34	119	tk 38409-35	100
tk 38387-14	98	tk 38399-18	137	tk 38405-36	119	tk 38409-40	100
tk 38387-16	98	tk 38399-19	137	tk 38405-38	119	tk 38409-45	100
tk 38387-18	98	tk 38399-20	130	tk 38405-40	119	tk 38409-50	100
tk 38388-00	59	tk 38399-21	130	tk 38407-10	100	tk 38410-00	71
tk 38388-01	59, 135	tk 38400-00	101	tk 38407-12	100	tk 38410-01	71
tk 38388-09	122	tk 38401-06	119	tk 38407-14	100	tk 38410-02	71
tk 38388-10	102, 122	tk 38401-07	119	tk 38407-16	100	tk 38410-03	71
tk 38389-05	62, 123	tk 38401-08	119	tk 38407-18	100	tk 38410-04	71
tk 38389-07	62, 104, 123	tk 38401-09	119	tk 38407-20	100	tk 38410-14	71
tk 38389-12	62	tk 38401-10	119	tk 38407-22	100	tk 38410-16	71
tk 38389-18	62, 136	tk 38401-11	119	tk 38407-24	100	tk 38410-18	71
tk 38389-19	136	tk 38401-12	119	tk 38407-26	100	tk 38410-20	71

Nummernverzeichnis
Numerical Index
Index numériques
Indice numerico
Indice dei numeri d'articolo

Art. Nr.	Seite	Art. Nr.	Seite	Art. Nr.	Seite	Art. Nr.	Seite
tk 38410-22	71	tk 38413-08	120	tk 38416-90	70	tk 38421-85	128
tk 38410-24	71	tk 38413-10	120	tk 38416-95	70	tk 38421-90	128
tk 38410-26	71	tk 38413-12	120	tk 38417-08	74	tk 38421-95	128
tk 38410-28	71	tk 38413-14	120	tk 38418-00	70	tk 38423-00	128
tk 38410-30	71	tk 38413-16	120	tk 38418-05	70	tk 38423-05	128
tk 38410-32	71	tk 38413-18	120	tk 38418-10	70	tk 38423-10	128
tk 38410-34	71	tk 38413-20	120	tk 38418-15	70	tk 38423-15	128
tk 38410-36	71	tk 38413-22	120	tk 38418-20	70	tk 38423-20	128
tk 38410-38	71	tk 38413-24	120	tk 38418-25	70	tk 38423-25	128
tk 38410-40	71	tk 38413-26	120	tk 38418-30	70	tk 38423-30	128
tk 38410-42	71	tk 38413-28	120	tk 38418-35	70	tk 38423-45	128
tk 38410-44	71	tk 38413-30	120	tk 38418-40	70	tk 38423-50	128
tk 38410-46	71	tk 38413-32	120	tk 38418-45	70	tk 38423-55	128
tk 38410-48	71	tk 38413-34	120	tk 38418-50	70	tk 38423-60	128
tk 38410-50	71	tk 38413-36	120	tk 38418-55	70	tk 38423-65	128
tk 38410-52	71	tk 38413-38	120	tk 38418-60	70	tk 38423-70	128
tk 38410-54	71	tk 38413-40	120	tk 38418-65	70	tk 38423-75	128
tk 38410-56	71	tk 38414-00	70	tk 38418-70	70	tk 38423-80	128
tk 38410-58	71	tk 38414-05	70	tk 38418-75	70	tk 38423-85	128
tk 38410-60	71	tk 38414-10	70	tk 38418-80	70	tk 38423-90	128
tk 38410-65	71	tk 38414-15	70	tk 38418-85	70	tk 38423-95	128
tk 38410-70	71	tk 38414-20	70	tk 38418-90	70	tk 38425-10	101
tk 38410-75	71	tk 38414-25	70	tk 38418-95	70	tk 38425-12	101
tk 38410-80	71	tk 38414-30	70	tk 38420-00	128	tk 38425-14	101
tk 38410-85	71	tk 38414-35	70	tk 38420-05	128	tk 38425-16	101
tk 38410-90	71	tk 38414-40	70	tk 38420-10	128	tk 38425-18	101
tk 38410-95	71	tk 38414-45	70	tk 38420-15	128	tk 38425-20	101
tk 38411-10	100	tk 38414-50	70	tk 38420-20	128	tk 38425-22	101
tk 38411-12	100	tk 38414-55	70	tk 38420-22	128	tk 38425-24	101
tk 38411-14	100	tk 38414-60	70	tk 38420-24	128	tk 38425-26	101
tk 38411-16	100	tk 38414-65	70	tk 38420-30	128	tk 38425-28	101
tk 38411-18	100	tk 38414-70	70	tk 38420-35	128	tk 38425-30	101
tk 38411-20	100	tk 38414-75	70	tk 38420-40	128	tk 38425-32	101
tk 38411-22	100	tk 38414-80	70	tk 38420-45	128	tk 38425-34	101
tk 38411-24	100	tk 38414-85	70	tk 38420-50	128	tk 38425-36	101
tk 38411-26	100	tk 38414-90	70	tk 38420-55	128	tk 38425-38	101
tk 38411-28	100	tk 38414-95	70	tk 38420-60	128	tk 38425-40	101
tk 38411-30	100	tk 38415-07	133	tk 38420-65	128	tk 38425-45	101
tk 38411-32	100	tk 38415-11	74, 133	tk 38420-70	128	tk 38425-50	101
tk 38411-35	100	tk 38415-13	74	tk 38420-75	128	tk 38425-55	101
tk 38411-40	100	tk 38415-14	74	tk 38420-80	128	tk 38425-60	101
tk 38411-45	100	tk 38415-15	74	tk 38420-85	128	tk 38425-65	101
tk 38411-50	100	tk 38416-00	70	tk 38420-90	128	tk 38425-70	101
tk 38411-55	100	tk 38416-05	70	tk 38420-95	128	tk 38425-75	101
tk 38411-60	100	tk 38416-10	70	tk 38421-00	128	tk 38425-80	101
tk 38412-20	73	tk 38416-15	70	tk 38421-05	128	tk 38427-06	120
tk 38412-25	73	tk 38416-20	70	tk 38421-10	128	tk 38427-07	120
tk 38412-30	73	tk 38416-30	70	tk 38421-15	128	tk 38427-08	120
tk 38412-35	73	tk 38416-35	70	tk 38421-20	128	tk 38427-09	120
tk 38412-40	73	tk 38416-40	70	tk 38421-25	128	tk 38427-10	120
tk 38412-45	73	tk 38416-45	70	tk 38421-30	128	tk 38427-11	120
tk 38412-50	73	tk 38416-50	70	tk 38421-45	128	tk 38427-12	120
tk 38412-55	73	tk 38416-55	70	tk 38421-50	128	tk 38427-14	120
tk 38412-60	73	tk 38416-60	70	tk 38421-55	128	tk 38427-16	120
tk 38412-65	73	tk 38416-65	70	tk 38421-60	128	tk 38427-18	120
tk 38412-70	73	tk 38416-70	70	tk 38421-65	128	tk 38427-20	120
tk 38412-75	73	tk 38416-75	70	tk 38421-70	128	tk 38428-00	72
tk 38412-80	73	tk 38416-80	70	tk 38421-75	128	tk 38428-05	72
tk 38413-06	120	tk 38416-85	70	tk 38421-80	128	tk 38428-10	72

Nummernverzeichnis
Numerical Index

Index numériques

Indice numerico

Indice dei numeri d'articolo

Art. Nr.	Seite	Art. Nr.	Seite	Art. Nr.	Seite	Art. Nr.	Seite
tk 38428-22	72	tk 38430-02	71	tk 38444-50	126	tk 38456-30	139
tk 38428-24	72	tk 38430-03	71	tk 38444-60	68	tk 38457-10	139
tk 38428-26	72	tk 38430-04	71	tk 38445-20	90	tk 38457-12	139
tk 38428-28	72	tk 38430-14	71	tk 38445-30	112	tk 38457-14	139
tk 38428-30	72	tk 38430-16	71	tk 38446-10	144	tk 38457-15	139
tk 38428-32	72	tk 38430-18	71	tk 38447-08	139	tk 38457-16	139
tk 38428-34	72	tk 38430-20	71	tk 38447-10	139	tk 38457-18	139
tk 38428-36	72	tk 38430-22	71	tk 38447-12	139	tk 38457-20	139
tk 38428-38	72	tk 38430-24	71	tk 38447-14	139	tk 38457-22	139
tk 38428-40	72	tk 38430-26	71	tk 38447-15	139	tk 38457-25	139
tk 38428-42	72	tk 38430-28	71	tk 38447-16	139	tk 38460-10	139
tk 38428-44	72	tk 38430-30	71	tk 38447-17	139	tk 38460-12	139
tk 38428-46	72	tk 38430-32	71	tk 38447-18	139	tk 38460-15	139
tk 38428-48	72	tk 38430-34	71	tk 38447-20	139	tk 38460-16	139
tk 38428-50	72	tk 38430-36	71	tk 38447-22	139	tk 38460-17	139
tk 38428-52	72	tk 38430-38	71	tk 38447-25	139	tk 38460-18	139
tk 38428-54	72	tk 38430-40	71	tk 38447-30	139	tk 38460-20	139
tk 38428-56	72	tk 38430-42	71	tk 38448-08	139	tk 38460-22	139
tk 38428-58	72	tk 38430-44	71	tk 38448-10	139	tk 38460-25	139
tk 38428-60	72	tk 38430-46	71	tk 38448-12	139	tk 38460-30	139
tk 38428-65	72	tk 38430-48	71	tk 38448-14	139	tk 38460-35	139
tk 38428-70	72	tk 38430-50	71	tk 38448-15	139	tk 38464-06	141
tk 38428-75	72	tk 38430-52	71	tk 38448-16	139	tk 38464-08	141
tk 38428-80	72	tk 38430-54	71	tk 38448-18	139	tk 38465-06	141
tk 38428-85	72	tk 38430-56	71	tk 38448-20	139	tk 38465-10	141
tk 38428-90	72	tk 38430-58	71	tk 38448-22	139	tk 38465-13	141
tk 38428-95	72	tk 38430-60	71	tk 38448-25	139	tk 38465-17	141
tk 38429-00	72	tk 38430-65	71	tk 38448-30	139	tk 38466-10	141
tk 38429-05	72	tk 38430-70	71	tk 38449-08	139	tk 38466-12	141
tk 38429-10	72	tk 38430-75	71	tk 38449-10	139	tk 38466-15	141
tk 38429-22	72	tk 38430-80	71	tk 38449-12	139	tk 38466-17	141
tk 38429-24	72	tk 38430-85	71	tk 38449-14	139	tk 38466-20	141
tk 38429-26	72	tk 38430-90	71	tk 38449-15	139	tk 38466-25	141
tk 38429-28	72	tk 38430-95	71	tk 38449-16	139	tk 38467-10	141
tk 38429-30	72	tk 38433-01	129	tk 38449-18	139	tk 38467-12	141
tk 38429-32	72	tk 38435-24	129	tk 38449-20	139	tk 38467-15	141
tk 38429-34	72	tk 38436-04	129	tk 38449-22	139	tk 38467-17	141
tk 38429-36	72	tk 38436-07	129	tk 38449-25	139	tk 38467-20	141
tk 38429-38	72	tk 38437-01	134	tk 38449-30	139	tk 38467-25	141
tk 38429-40	72	tk 38437-02	134	tk 38455-08	139	tk 38469-12	141
tk 38429-42	72	tk 38437-11	134	tk 38455-10	139	tk 38469-15	141
tk 38429-44	72	tk 38437-12	134	tk 38455-12	139	tk 38469-18	141
tk 38429-46	72	tk 38438-13	130	tk 38455-14	139	tk 38469-20	141
tk 38429-48	72	tk 38438-16	130	tk 38455-15	139	tk 38469-25	141
tk 38429-50	72	tk 38438-19	130	tk 38455-16	139	tk 38469-30	141
tk 38429-52	72	tk 38439-17	131	tk 38455-17	139	tk 38470-12	141
tk 38429-54	72	tk 38440-18	133	tk 38455-18	139	tk 38470-15	141
tk 38429-56	72	tk 38440-19	133	tk 38455-20	139	tk 38470-18	141
tk 38429-58	72	tk 38440-20	128	tk 38455-22	139	tk 38470-20	141
tk 38429-60	72	tk 38440-45	147	tk 38455-25	139	tk 38470-25	141
tk 38429-65	72	tk 38440-70	147	tk 38456-10	139	tk 38470-30	141
tk 38429-70	72	tk 38441-00	130	tk 38456-12	139	tk 38471-12	141
tk 38429-75	72	tk 38442-10	8	tk 38456-14	139	tk 38471-15	141
tk 38429-80	72	tk 38442-20	14	tk 38456-15	139	tk 38471-18	141
tk 38429-85	72	tk 38443-10	46	tk 38456-16	139	tk 38471-20	141
tk 38429-90	72	tk 38443-30	76	tk 38456-18	139	tk 38471-25	141
tk 38429-95	72	tk 38444-20	34	tk 38456-20	139	tk 38471-30	141
tk 38430-00	71	tk 38444-30	56	tk 38456-22	139	tk 38472-12	141
tk 38430-01	71	tk 38444-40	66	tk 38456-25	139	tk 38472-15	141

Nummernverzeichnis
Numerical Index
Index numériques
Indice numerico
Indice dei numeri d'articolo

Art. Nr.	Seite	Art. Nr.	Seite	Art. Nr.	Seite	Art. Nr.	Seite
tk 38472-18	141	tk 38488-25	58	tk 38552-12	146	tk 87014-02	173
tk 38472-20	141	tk 38488-27	58	tk 38553-10	146	tk 87014-03	173
tk 38472-25	141	tk 38488-32	58	tk 38553-12	146	tk 87014-04	173
tk 38472-30	141	tk 38488-33	58	tk 38554-22	149	tk 87015-01	173
tk 38473-08	139	tk 38488-35	58	tk 38554-23	150	tk 87015-02	173
tk 38473-10	139	tk 38488-36	58	tk 38555-18	151	tk 87015-03	173
tk 38473-15	139	tk 38488-40	58	tk 38556-15	151	tk 87015-04	173
tk 38473-25	139	tk 38488-45	58	tk 38557-18	151	tk 87020-00	175
tk 38477-08	140	tk 38488-50	135	tk 38558-57	152	tk 87021-00	175
tk 38477-10	140	tk 38488-51	135	tk 38560-26	150	tk 87021-10	175
tk 38477-12	140	tk 38488-52	135	tk 38561-14	151	tk 87021-15	175
tk 38477-14	140	tk 38488-53	135	tk 38561-22	149	tk 87022-00	175
tk 38477-15	140	tk 38489-01	59	tk 38562-13	153	tk 87025-00	175
tk 38477-18	140	tk 38489-02	59	tk 38562-18	153	tk 87025-01	175
tk 38477-20	140	tk 38489-03	59	tk 38563-14	153	tk 87025-02	175
tk 38477-22	140	tk 38489-04	59	tk 38563-17	153	tk 87025-03	175
tk 38477-25	140	tk 38489-05	59	tk 38564-05	153	tk 87025-04	175
tk 38477-30	140	tk 38489-06	59	tk 38564-07	153	tk 87026-07	175
tk 38478-08	140	tk 38489-15	59, 121	tk 38569-01	154	tk 87026-08	175
tk 38478-10	140	tk 38489-20	59, 121	tk 38569-17	154	tk 87026-09	175
tk 38478-12	140	tk 38489-27	59, 121	tk 38571-05	153	tk 87026-10	175
tk 38478-14	140	tk 38489-34	59, 102, 135	tk 38571-07	153	tk 87028-00	175
tk 38478-15	140	tk 38489-35	59, 102	tk 38572-16	148	tk 87029-00	175
tk 38478-18	140	tk 38489-36	59, 102	tk 38572-20	108	tk 87100-1F-BK	174
tk 38478-20	140	tk 38489-37	59, 135	tk 38573-01	64, 155	tk 87100-1F-BL	174
tk 38478-22	140	tk 38489-38	59	tk 38573-02	64, 155	tk 87100-1F-GR	174
tk 38478-25	140	tk 38489-65	59	tk 38573-18	154	tk 87100-1F-RE	174
tk 38478-30	140	tk 38517-01	147	tk 38573-20	154	tk 87100-1F-SI	174
tk 38479-08	140	tk 38517-02	147	tk 38573-24	154	tk 87100-1F-YE	174
tk 38479-10	140	tk 38517-03	147	tk 38580-01	171	tk 87100-1FS-BK	174
tk 38479-12	140	tk 38518-28	147	tk 38580-02	171	tk 87100-1FS-BL	174
tk 38479-14	140	tk 38520-21	146	tk 38580-03	171	tk 87100-1FS-GR	174
tk 38479-15	140	tk 38532-13	146	tk 38580-04	171	tk 87100-1FS-RE	174
tk 38479-18	140	tk 38541-00	63	tk 38580-05	171	tk 87100-1FS-SI	174
tk 38479-20	140	tk 38541-02	65	tk 38581-01	171	tk 87100-1FS-YE	174
tk 38479-22	140	tk 38541-05	63	tk 38581-02	171	tk 87110-1F-BK	174
tk 38479-25	140	tk 38541-07	63	tk 38581-03	171	tk 87110-1F-BL	174
tk 38479-30	140	tk 38541-09	63	tk 38582-01	172	tk 87110-1F-GR	174
tk 38483-16	142	tk 38542-01	62	tk 38582-02	172	tk 87110-1F-RE	174
tk 38483-22	142	tk 38542-08	122	tk 38583-18	171	tk 87110-1F-SI	174
tk 38484-16	142	tk 38542-10	105, 122	tk 38584-19	172	tk 87110-1F-YE	174
tk 38484-22	142	tk 38542-11	105	tk 38596-75	172	tk 87110-1FS-BK	174
tk 38485-21	142	tk 38542-15	106	tk 38597-90	172	tk 87110-1FS-BL	174
tk 38486-16	142	tk 38542-25	106	tk 38598-11	172	tk 87110-1FS-GR	174
tk 38487-20	142	tk 38542-35	62, 106	tk 38598-21	172	tk 87110-1FS-RE	174
tk 38488-01	58, 121	tk 38548-04	106	tk 85200-01	138	tk 87110-1FS-SI	174
tk 38488-02	58, 121	tk 38550-02	146	tk 85201-01	137, 138	tk 87110-1FS-YE	174
tk 38488-03	58, 121	tk 38550-03	146	tk 85201-02	137, 138	tk 87120-1F-BK	174
tk 38488-04	58, 104, 121	tk 38550-04	146	tk 85201-03	137, 138	tk 87120-1F-BL	174
tk 38488-05	58, 121	tk 38550-05	146	tk 85201-04	137, 138	tk 87120-1F-GR	174
tk 38488-06	58	tk 38550-06	146	tk 85201-05	137, 138	tk 87120-1F-RE	174
tk 38488-07	58	tk 38550-07	146	tk 85201-06	137, 138	tk 87120-1F-SI	174
tk 38488-08	58, 104	tk 38550-08	146	tk 85201-07	137, 138	tk 87120-1F-YE	174
tk 38488-09	58	tk 38550-09	146	tk 85201-08	137, 138	tk 87120-1FS-BK	174
tk 38488-10	58	tk 38550-10	146	tk 87010-01	174	tk 87120-1FS-BL	174
tk 38488-11	58	tk 38550-12	146	tk 87010-02	174	tk 87120-1FS-GR	174
tk 38488-12	58	tk 38550-15	146	tk 87010-03	174	tk 87120-1FS-RE	174
tk 38488-15	58	tk 38552-08	146	tk 87010-04	174	tk 87120-1FS-SI	174
tk 38488-20	58	tk 38552-10	146	tk 87014-01	173	tk 87120-1FS-YE	174

Nummernverzeichnis
Numerical Index

Index numériques

Indice numerico

Indice dei numeri d'articolo

Art. Nr.	Seite	Art. Nr.	Seite	Art. Nr.	Seite	Art. Nr.	Seite
tk 87130-1F-BK	174	tk 87190-1FS-YE	173				
tk 87130-1F-BL	174	tk 87200-1F-BK	173				
tk 87130-1F-GR	174	tk 87200-1F-BL	173				
tk 87130-1F-RE	174	tk 87200-1F-GR	173				
tk 87130-1F-SI	174	tk 87200-1F-RE	173				
tk 87130-1F-YE	174	tk 87200-1F-SI	173				
tk 87130-1FS-BK	174	tk 87200-1F-YE	173				
tk 87130-1FS-BL	174	tk 87200-1FS-BK	173				
tk 87130-1FS-GR	174	tk 87200-1FS-BL	173				
tk 87130-1FS-RE	174	tk 87200-1FS-GR	173				
tk 87130-1FS-SI	174	tk 87200-1FS-RE	173				
tk 87130-1FS-YE	174	tk 87200-1FS-SI	173				
tk 87136-1F-BK	174	tk 87200-1FS-YE	173				
tk 87136-1F-BL	174	tk 87210-1F-BK	173				
tk 87136-1F-GR	174	tk 87210-1F-BL	173				
tk 87136-1F-RE	174	tk 87210-1F-GR	173				
tk 87136-1F-SI	174	tk 87210-1F-RE	173				
tk 87136-1F-YE	174	tk 87210-1F-SI	173				
tk 87136-1FS-BK	174	tk 87210-1F-YE	173				
tk 87136-1FS-BL	174	tk 87210-1FS-BK	173				
tk 87136-1FS-GR	174	tk 87210-1FS-BL	173				
tk 87136-1FS-RE	174	tk 87210-1FS-GR	173				
tk 87136-1FS-SI	174	tk 87210-1FS-RE	173				
tk 87136-1FS-YE	174	tk 87210-1FS-SI	173				
tk 87170-1F-BK	173	tk 87210-1FS-YE	173				
tk 87170-1F-BL	173						
tk 87170-1F-GR	173						
tk 87170-1F-RE	173						
tk 87170-1F-SI	173						
tk 87170-1F-YE	173						
tk 87170-1FS-BK	173						
tk 87170-1FS-BL	173						
tk 87170-1FS-GR	173						
tk 87170-1FS-RE	173						
tk 87170-1FS-SI	173						
tk 87170-1FS-YE	173						
tk 87180-1F-BK	173						
tk 87180-1F-BL	173						
tk 87180-1F-GR	173						
tk 87180-1F-RE	173						
tk 87180-1F-SI	173						
tk 87180-1F-YE	173						
tk 87180-1FS-BK	173						
tk 87180-1FS-BL	173						
tk 87180-1FS-GR	173						
tk 87180-1FS-RE	173						
tk 87180-1FS-SI	173						
tk 87180-1FS-YE	173						
tk 87190-1F-BK	173						
tk 87190-1F-BL	173						
tk 87190-1F-GR	173						
tk 87190-1F-RE	173						
tk 87190-1F-SI	173						
tk 87190-1F-YE	173						
tk 87190-1FS-BK	173						
tk 87190-1FS-BL	173						
tk 87190-1FS-GR	173						
tk 87190-1FS-RE	173						
tk 87190-1FS-SI	173						

Notizen
Notes

Notices
Notas
Note

Notizen | Notices
Notes | *Notas*
Note

Notizen
Notes

Notices
Notas
Note

Wichtige Hinweise

Dieser Katalog bleibt Eigentum der Firma TEKNO-MEDICAL Optik-Chirurgie GmbH, auch wenn dafür eine Schutzgebühr bezahlt wurde. Er kann von uns jederzeit zurückgefordert werden, wenn er gegen unsere Interessen und nicht zum Vertrieb und Einkauf von TEKNO Produkten verwendet wird. Auch behalten wir uns in solch einem Falle weitergehende Maßnahmen vor.

Der Nachdruck oder Kopieren dieses Kataloges – im Gesamten oder auch nur auszugsweise – ist ohne unsere schriftliche Genehmigung verboten. Modelländerungen vorbehalten. Gedruckt in der Bundesrepublik Deutschland

Important notice

This catalogue remains property of TEKNO-MEDICAL Optik-Chirurgie GmbH even if we have asked for a lending fee. We can at any time recall the catalogue, in case that it has been not used according to our interests, i.e. sale or purchase of TEKNO products. We preserve the right for further steps in that case.

Reproduction or copying of this catalogue in whole or in parts is forbidden without our written permission. Patterns are subject to change. Printed in Germany

Indications importantes

Ce catalogue reste la propriété de TEKNO-MEDICAL Optik-Chirurgie GmbH, même si nous avons demandé le paiement d'une taxe de protection. Nous pouvons demander le retour du catalogue dans le cas où celui-ci n'est pas utilisé conformément à nos intérêts, pour la vente ou l'achat de nos produits. Dans ce cas nous nous réservons le droits de mener des actions juridiques.

La reproduction ou la copie totale ou partielle de ce catalogue est interdite sans notre accord écrit. Sous réserve des modifications techniques. Imprimé en Allemagne

Avisos importantes

Este catálogo es propiedad de TEKNO-MEDICAL Optik-Chirurgie GmbH, aún en el caso de haber abonado por él una tasa de colaboración. Podemos solicitar la devolución del catálogo en caso de que no sea utilizado para la compra o venta de nuestros productos. En este caso nos reservamos el derecho de tomar medidas jurídicas.

La reproducción o copia total o parcial de este catálogo esta prohibido sin nuestro consentimiento escrito. Salvo modificaciones técnicas. Impreso en la República Federal de Alemania

Avvertenze importanti

Questo catalogo rimane proprietà della TEKNO-MEDICAL Optik-Chirurgie GmbH, anche se è stato rilasciato gratuitamente contro pagamento. Possiamo in ogni momento richiederlo indietro, in caso non stato usato in accordo con i nostri interessi (acquisto e vendita dei prodotti TEKNO-Medical). Ci riserviamo in questo caso il diritto di prendere ulteriori provvedimenti.

La copia o la riproduzione di questo catalogo in parte o nella sua totalità è vietata senza il nostro permesso scritto. Ci riserviamo la facoltà di cambiamenti nei modelli. Stampato in Germania



TEKNO-MEDICAL Optik-Chirurgie GmbH

Sattlerstrasse 11 · 78532 Tuttlingen, Germany

Telefon +49 (74 61) 1701-0 · Fax +49 (74 61) 1701-50

mail@tekno-medical.com · www.tekno-medical.com

© 11.2011 - TEKNO-MEDICAL Optik-Chirurgie GmbH

TEKNO is a registered trademark of TEKNO-MEDICAL Optik-Chirurgie GmbH