



SURGERY
PLASTIC SURGERY

Plastische Chirurgie | Chirurgie plastique
Plastic surgery | *Cirurgia plástica*
Chirurgia plastica



Kataloge
Catalogues

Catalogues
Catálogos
Cataloghi

Endoskopie
Endoscopy

Endoscopia
Endoscopia
Endoscopia



Geräte
Units
Appareils
Equipos
Apparecchi

ENDOSCOPY No. **205**



Sinuskopie
Sinuscopy
Sinuscopie
Sinuscopía
Sinuscopia

ENDOSCOPY No. **211**



Optiken
Scopes
Optiques
Ópticas
Ottiche

ENDOSCOPY No. **206**



Mini & Mikro System für MIC
Mini & micro system for MIS
Système mini & mikro pour MIC
Sistema mini y micro para MIC
Sistema mini e micro per MIC

ENDOSCOPY No. **213**



Laparoskopie
Laparoscopy
Laparoscopie
Laparoscopia
Laparoscopia

ENDOSCOPY No. **207**

Sterilisation
Sterilization

Stérilisation
Esterilización
Sterilizzazione



Urologie
Urology
Urologie
Urología
Urologia

ENDOSCOPY No. **208**



Steril Container - System I
Sterile container - system I
Contenaires pour stérilisation - système I
Contenedores para esterilización - sistema I
Container per sterilizzazione - sistema I

STERILIZATION No. **302**



Gynäkologie
Gynaecology
Gynécologie
Ginecología
Ginecologia

ENDOSCOPY No. **209**



Steril Container - System II
Sterile container - system II
Contenaires pour stérilisation - système II
Contenedores para esterilización - sistema II
Container per sterilizzazione - sistema II

STERILIZATION No. **303**



Arthroskopie
Arthroscopy
Arthroscopie
Artroscopia
Artroscopia

ENDOSCOPY No. **210**

Kataloge
Catalogues
Catálogos
Cataloghi

Chirurgie
Surgery
Chirurgie
Cirugía
Chirurgia



Hauptkatalog Chirurgie
Main catalogue surgery
Catalogue général
Catálogo general
Catalogo generale

SURGERY No. **111**



Aneurysmen Clips
Aneurysm clips
Clips pour anévrismes
Clips para aneurismas
Clips per aneurismi

SURGERY No. **134**



Plastische Chirurgie
Plastic surgery
Chirurgie plastique
Cirugía plástica
Chirurgia plastica

SURGERY No. **112**



HNO Hauptkatalog
ENT main catalogue
ORL catalogue général
ORL catálogo general
ORL catalogo generale

ENT No. **501**



Ophthalmologie
Ophthalmology
Ophthalmologie
Oftalmología
Oftalmologia

SURGERY No. **113**

Elektro Chirurgie
Electro surgery
Eléctrochirurgie
Electro-Cirugía
Elettrobisturi



Traumatologie
Traumatology
Traumatologie
Traumatología
Traumatologia

SURGERY No. **114**



Elektro Chirurgie
Electro surgery
Eléctrochirurgie
Electro-Cirugía
Elettrobisturi

ELECTRO SURGERY No. **212**



Gefäßschirurgie
Vascular surgery
Chirurgie vasculaire
Cirugía vascular
Chirurgia vascolare

SURGERY No. **115**

Dental
Dental
Dentaire
Dental
Dentale



Retraktor Systeme
Retractor systems
Systèmes des écarteurs
Sistema de retractores
Sistemi di retrattori

SURGERY No. **133**

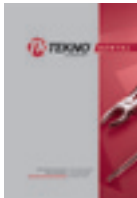

Dental
Dental
Dentaire
Dental
Dentale

DENTAL No. **402**

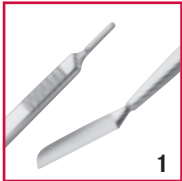
**Inhalt
Content**
**Contenu
Contenido
Indice di catalogo**

Skalpelle / Dermatome
Scalpels / Dermatomes
Bistouris / Dermatomes
Bisturías / Dermatomos
Bisturi / Dermatomi

6 - 10

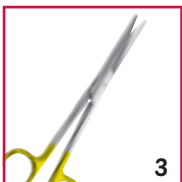

Messinstrumente / Bleihände
Measuring instruments / Leadhands
Instruments pour mesurer / Mains en plomb
Instrumentos de medida / Manos de plomo
Strumenti di misurazione / Mani di piombo

11 - 12

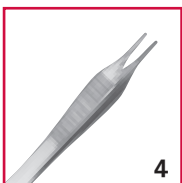
Scheren
Scissors
Ciseaux
Tijeras
Forbici

13 - 51

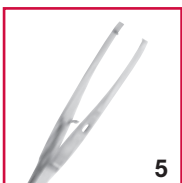
Pinzetten
Forceps
Pinces
Pinzas
Pinze

52 - 65

Approximatoren, Gefäßclips
Approximators, vessel clips
Approximateurs, clips
Approximadores, clips
Approssiamator, clips

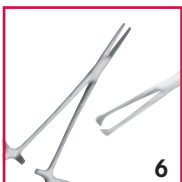
66 - 69

Arterienklemmen, Fasszangen / Gewebe- und Darmfasszangen / Tupfer- und Schwammzangen
Haemostatic forceps / Tissue and intestinal holding forceps / Cotton swab forceps, sponge holding forceps
Pince hémostatiques / Pincés intestinales et de tissue / Pincés à tampons et éponges
Pinzas hemostáticas / Pinzas para tejidos y intestinos / Pinzas para tampones y esponjas
Pinze emostatiche / Pinze per tessuti ed intestinali / Pinzer per tamponi

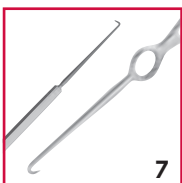
70 - 83

Häkchen / Weichteilhaken für die Kieferchirurgie / Wundhaken-Wundsperrer
Retractors / Soft tissue retractors for maxillo-facial surgery / Retractors-wound spreader, self-retaining
Ecarteurs / Ecarteurs pour la chirurgie maxillo-faciale / Ecarteurs-écarteurs autostatiques
Separadores / Ganchos para cirugía maxilofacial / Separadores-separadores autoestáticos
Uncini / Uncini per chirurgia massilofaciale / Divaricatori-divaricatori autostatici

84 - 103

Inhalt	Contenu
Content	Contenido
	Indice di catalogo

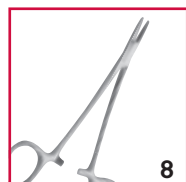

Nadelhalter
Needle holders
 Porte-aiguilles
 Porta-agujas
 Porta aghi

104 - 122

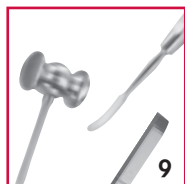

Hämmer / Meißel / Elevatorien / Raspatorien
Mallets / Chisels / Elevators / Periosteal elevators
 Maillets / Ostéotomes / Elevateurs / Rugines
Martillos / Cinceles / Elevadores / Periostótmos
 Martelli / Scalpelli / Elevatori / Raspatori

123 - 139



Nasenspekula / Nasensägen
Nasal specula / Nasal saws
 Spéculums nasaux / Scies nasales
Éspeculos nasales / Sierras nasales
 Specoli nasali / Seghe nasali

140 - 143

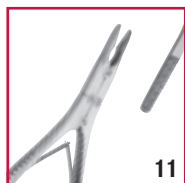

Nasenraspeln / Septumzangen / Hohlmeißelzangen / Knochensplitterzangen
Nasal rasps / Septum forceps / Bone rongeurs / Bone cutting forceps
 Râpes nasaux / Pincés pour la cloison nasale / Pince gouges / Pincés coupantes à os
Limas nasales / Pinzas para el tabique nasal / Pinzas gubias / Pinzas cortantes para huesos
 Raspe nasali / Pinze per il setto nasale / Pinze sgorbie / Cesoi per ossa

144 - 157

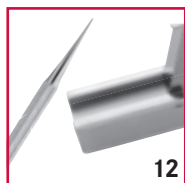

Tränenkanal-Dilatatoren / Knorpelquetscher
Lacrimal dilators / Bone crusher
 Dilatateurs pour le canal lacrymal / Broyeur pour os
Dilatadores para el canal lacrimal / Prensa para huesos
 Dilatatori lacrimali / Trittatore osseo

158 - 160

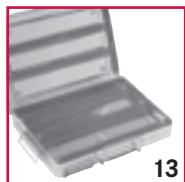

Instrumenten-Kassetten / Grundinstrumentarium für die plastische Chirurgie
Instrument trays / Basic set for plastic surgery
 Contenaires d'instrument / Set de base pour la chirurgie plastique
Cajas para instrumental / Juego de base para la cirugía plastica
 Scatole per sterilizzazione / Set di base per la chirurgia plastica

161 - 163

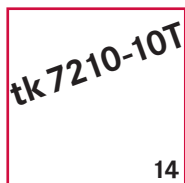

Nummernverzeichnis / Inhaltsverzeichnis
Numerical index / Index
 Index numériques / Table de matière
Indice numerico / Indice
 Indice der numeri d'articolo / Indice

164 - 183

tk 7210-10T

14

Mikroklingen Halter – Mikroklingen
Micro-blade holder – Micro-blades

Porte micro-lames – Micro-lames
Porta para micro-hojas – Micro-hojas
Porta micro-lame – Micro-lame



1:1

135 mm – 5¼"

tk 7120-13

Titan
Titanium
Titan
Titanio
Titanio



1:1



1:1



1:1



1:1

Fig. 63

tk 7121-03

Fig. 64

tk 7121-04

Fig. 67

tk 7121-07

Fig. 69

tk 7121-09

Mikroklingen – Packung mit 25 Stück

Micro-Spare blade – package of 25 pieces

Micro-Lame de réchange – paquet de 25 pièces

Micro-Hoja de cambio – paquete de 25 piezas

Micro-Lame di ricambio – confezione da 25 pezzi



Die abgebildeten Klingen sind steril

The blades on this page are sterile

Les lames de cette page sont stériles

Los hojas de esta pagina son esteriles

Le lame illustrate sono sterili

Skalpelli-Griffe | Manches de bistouri
 Scalpel handles | Mangos de bisturí
 Manici per bisturi



STANDARD

Fig. 3

tk7110-03

STANDARD

Fig. 4

tk7100-04

BARRON

Fig. 3

tk7113-03

Fig. 3 R

tk7115-03

Fig. 3 RG

tk7116-03

Fig. 7K

tk7110-71

Fig. 7

tk7110-07

Skalpellsklingen
Scalpel blades

Lames de bistouris
Hojas de bisturí
Lame per bisturi



Packung mit 100 Stück
Package of 100 pieces
Paquet de 100 pièces
Paquetes de 100 piezas
Confezione da 100 pezzi



Die abgebildeten Klingen sind steril
The blades on this page are sterile
Les lames de cette page sont stériles
Los hojas de este pagina son esteriles
Le lame illustrate sono sterili



1:1
Fig. 10



1:1
Fig. 11



1:1
Fig. 12



1:1
Fig. 12d



1:1
Fig. 15



1:1
Fig. 15c

tk 7210-10T	tk 7210-11T	tk 7210-12T	tk 7210-12DT	tk 7210-15T	tk 7210-15CT
-------------	-------------	-------------	--------------	-------------	--------------

doppelschneidend
double cutting edge
double tranchante
corta doble
a doppio taglio

passend für Griffe: tk 7110-03, tk 7111-03, tk 7110-07, tk 7110-71, tk 7112-03, tk 7113-03, tk 7115-03, tk 7116-03
for handles: tk 7110-03, tk 7111-03, tk 7110-07, tk 7110-71, tk 7112-03, tk 7113-03, tk 7115-03, tk 7116-03
pour manches: tk 7110-03, tk 7111-03, tk 7110-07, tk 7110-71, tk 7112-03, tk 7113-03, tk 7115-03, tk 7116-03
para mangos: tk 7110-03, tk 7111-03, tk 7110-07, tk 7110-71, tk 7112-03, tk 7113-03, tk 7115-03, tk 7116-03
per manici: tk 7110-03, tk 7111-03, tk 7110-07, tk 7110-71, tk 7112-03, tk 7113-03, tk 7115-03, tk 7116-03

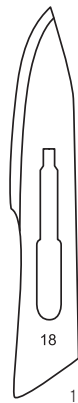

Fig. 18



Fig. 20

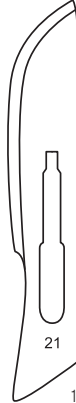

Fig. 21



Fig. 22



Fig. 23



Fig. 24

tk 7210-18T	tk 7210-20T	tk 7210-21T	tk 7210-22T	tk 7210-23T	tk 7210-24T
-------------	-------------	-------------	-------------	-------------	-------------

passend für Griffe: tk 7100-04, tk 7101-04, tk 7102-04, tk 7105-08
for handles: tk 7100-04, tk 7101-04, tk 7102-04, tk 7105-08
pour manches: tk 7100-04, tk 7101-04, tk 7102-04, tk 7105-08
para mangos: tk 7100-04, tk 7101-04, tk 7102-04, tk 7105-08
per manici: tk 7100-04, tk 7101-04, tk 7102-04, tk 7105-08

Dermatome
Dermatomes

Dermatomes
Dermatomos
Dermatomi



1:2

T I E R S C H

200 mm - 8"

tk 7890-20



1:2

S C H I N K

tk 7900-00 | 300 mm - 12"

komplett mit 1 Klinge und 2 Spannhaltern
complete with 1 blade and 2 plates
complet avec 1 lame et 2 plaques
completo con 1 hoja y 2 placas
completo con 1 lama e 2 placche



1:2

tk 7901-00

Ersatzklinge
spare blade

lame de rechange
hoja de cambio
lama di ricambio



1:2

S C H I N K

tk 7902-00

Spannplatte
Skin fixing plate

Plaque pour tendre la peau
Placa para extender la piel
Placca per stendere la pelle

Dermatome
Dermatomes

Dermatomes
Dermatomos
Dermatomi



1:2

HUMBY

310 mm - 12 1/4"

tk 7905-00

komplett mit 1 Klinge
complete with 1 blade
complet avec 1 lame
completo con 1 hoja
completo con 1 lama



1:2

tk 7908-00

Ersatzklinge für tk7905-00, tk7907-00
spare blade for tk7905-00, tk7907-00

lame de rechange pour tk7905-00, tk7907-00

hoja de cambio para tk7905-00, tk7907-00

lama di ricambio per tk7905-00, tk7907-00



1:2

WATSON

300 mm - 12"

tk 7907-00

komplett mit 1 Klinge, Stange starr
complete with 1 blade, fixed bar
complet avec 1 lame, tige fix
completo con 1 hoja, barra fijada
completo con 1 lama, barra fissa

Messinstrumente | Instruments à mesurer
Measuring instruments | Instrumentos de medida
 Strumenti per la misurazione



Ø = 32 mm	Ø = 37 mm	Ø = 43 mm
tk4664-01	tk4664-02	tk4664-03

Mamillerringe (stumpf)
Areola markers (blunt)
 Marqueurs pour l'aréole (mousses)
 Marcadores para areola (romos)
 Marcatori per areola (smussati)



FREEMAN					
Ø = 34 mm	Ø = 36 mm	Ø = 38 mm	Ø = 42 mm	Ø = 45 mm	Ø = 50 mm
tk4664-04	tk4664-05	tk4664-06	tk4664-07	tk4664-08	tk4664-09

Mamillerringe (stumpf)
Areola markers (blunt)
 Marqueurs pour l'aréole (mousses)
 Marcadores para areola (romos)
 Marcatori per areola (smussati)



CHANG
Ø = 38/42 mm
tk4664-10

Mamillerring (stumpf)
Areola marker (blunt)
 Marqueur pour l'aréole (mousses)
 Marcador para areola (romos)
 Marcatore per areola (smussati)



GROSSMAN
Ø = 48/52 mm
tk4664-11

Mamillerring (stumpf)
Areola marker (blunt)
 Marqueur pour l'aréole (mousses)
 Marcador para areola (romos)
 Marcatore per areola (smussati)

Für präzises Markieren der Brustwarze bei:
 - kombinierter Bruststraffung
 - Verkleinerung des Brustwarzenhofes
For precise marking of the nipple during:
 - combined breast-lifting
 - reduction of the areola

Pour marquage exact du mamelon en cas de:
 - lifting des seins combiné
 - réduction de l'aréole

Para la marcación precisa del pezón en caso de:
 - combinación con un lifting de la mama
 - reducción del tamaño de la areola mamaria

Per la marcatura esatta del capezzolo in caso di:
 - rassodamento combinato della mammella
 - riduzione del complesso areola-capezzolo



100 mm - 4"	tk4651-10
150 mm - 6"	tk4651-15
200 mm - 8"	tk4651-20
300 mm - 12"	tk4651-30
500 mm - 20"	tk4651-50

Bleihände
Leadhands

Mains en plomb
Manos de plomo
Mano di piombo



tk48180-01

für Kinder
child size
pour enfants
para niños
per bambini

tk48180-02

für Erwachsene
adult size
pour adultes
para adultos
per adulti



tk48180-03

für Erwachsene, mit Silikonüberzug
adult size with silicone coating
pour adultes, avec couche de silicone
para adultos, con cubierta de silicon
per adulti, rivestito di silicone

tk48180-04

für Kinder, mit Silikonüberzug
child size with silicone coating
pour enfants, avec couche de silicone
para niños, con cubierta de silicon
per bambini, rivestito di silicone

PRIMUSLINE

Scheren
Scissors

Ciseaux
Tijeras
Forbici

TEKNO **PRIMUSLINE** Scheren sind Scheren von höchster Qualität. Sowohl die Bearbeitung der TEKNO **PRIMUSLINE** Scheren wie auch der Schliff der Schneide werden ausschließlich auf modernsten CNC Maschinen durchgeführt. Diese modernen Fertigungsverfahren erlauben höchste Maßgenauigkeit. Die Präzision der Schnittfläche und des Schraubschlusses ermöglichen einen optimalen, lang anhaltenden Schnitt und Gang. Die Oberfläche der Branchen ist blendfrei gehalten um ein störungsfreies Arbeiten zu garantieren.

*TEKNO **PRIMUSLINE** scissors are surgical scissors of highest quality. The processing of the TEKNO **PRIMUSLINE** scissors, as well as the sharpening of the blades is done on advanced numeric controlled machines. These contemporary production methods allow the highest accuracy of measurements. The precision of the blades and the lock stand for a superior cutting quality. The non-reflective surface of the handles guarantees an interference free working*

TEKNO **PRIMUSLINE** ciseaux sont des instruments chirurgicaux de qualité supérieure. L'usinage des ciseaux TEKNO **PRIMUSLINE** et le tranchant des lames sont exécutés sur des centres de contrôle numérique les plus modernes. Ces procédés de fabrication innovatifs offrent le plus haut degré d'exactitude. La précision du coupe des lame et du raccord vissé permettent une qualité de coupe excellente. Le surface anti-éblouissante des branches garantit un travail sans perturbations.

*TEKNO **PRIMUSLINE** tijeras son instrumentos quirúrgicos de alta calidad. La producción de las tijeras TEKNO **PRIMUSLINE** y también la afiladura de las hojas son realizados con máquinas modernas de control numérico. Estes procedimientos de fabricación de generación moderna garantizan el grado mas alto de exactitud. La alta precisión del filo de las hojas y del cierre permiten una calidad de corte exelente. La superficie antideslumbrante de los mangos garantiza un trabajo sin perturbaciones.*

Le forbici TEKNO **PRIMUSLINE** sono forbici chirurgiche di altissima qualità. Tutta la lavorazione della forbici TEKNO **PRIMUSLINE** nonché anche l'affilatura vengono eseguite esclusivamente su macchine numeriche modernissime. Questi processi di produzione garantiscono misure esatte. La precisione della superficie di taglio e funzionamento ottimale per lungo tempo. Le superficie non riflettente dell'impugnatura permettono un lavoro senza disturbi di luce.



Technische Informationen
Technical information

Information technique
Información técnica
Informazione tecnica

PRIMUSLINE

Standard Cut

Hochwertige Scheren mit Standardschliff

High performance scissors with standard cutting edges

Ciseaux de haute qualité avec coupe standard

Tijeras de alta calidad con afiladura estándar

Forbici di altissima qualità con filettatura standard



SuperCut

Osteotomschliff und Mikroverzahnung

Präzises Präparieren und minimal traumatisierender Schnitt

Osteotom edges and micro serration

Precise dissection and minimal traumatizing cut

Coupe ostéotome et dentelure micro

Dissection précise et minimal traumatisante

Corte osteotomo y dentado micro

Dissección precisa mínima traumática

Affilatura a forma di osteotomo e dentellatura micro

Dissezione precisa e taglio minimamente traumatizzante



TC Cut

Eingeschweisste Hartmetallschneiden mit Standardschliff

Lange Schnitthaltigkeit

Welded tungsten-carbide cutting edges

Long lasting cutting ability

Plaques en carbure de tungstène soudées dans les lames

Qualité de coupe continue

Placas de carburo de tungsteno soldadas en las hojas

Calidad de corte permanente

Lame saldate al carburo di tungsteno con filettatura standard

Lunga durata di taglio



Technische Informationen
Technical information

Information technique
Información técnica
Informazione tecnica

PRIMUSLINE

TC SuperCut

Eingeschweisste Hartmetallschneiden, Osteotomschliff und Mikroverzahnung
Lange Schnitthaltigkeit, präzises Präparieren und minimal traumatisierender Schnitt

Welded tungsten-carbide cutting edges, osteotom edges and micro serration

Long lasting cutting ability, precise dissection and minimal traumatizing cut

Plaques en carbure de tungstène, coupe ostéotome et dentelure micro
Qualité de coupe continue, dissection précise et minimal traumatisante

Placas de carburo de tungsteno, corte osteotomo y dentado micro
Calidad de corte permanente, disección precisa mínima traumática

Lame saldate al carburo di tungsteno con affilatura a forma di osteotomo e dentellatura micro

Lunga durata di taglio, dissezione precisa e taglio minimamente traumatizzante



Ceramic SuperCut

Eingeschweisste Hartmetallschneide mit Osteotomschliff und Mikroverzahnung, schwarze Keramikbeschichtung
Lange Schnitthaltigkeit durch hohe Oberflächenhärte der Beschichtung, blendfreie Oberfläche, präzises Präparieren und minimal traumatisierender Schnitt

Welded tungsten-carbide cutting edges with osteotom edges and micro serration, black ceramic coating

Long lasting cutting ability due to high surface hardness of the coating, anti-glaring surface, better vision, precise dissection and minimal traumatizing cut

Plaques en carbure de tungstène, coupe ostéotome et dentelure micro, surface céramisée

Qualité de coupe continue, dissection précise et minimal traumatisante, surface anti-éblouissante

Placas de carburo de tungsteno, corte osteotomo y dentado micro, superficie cerámica

Calidad de corte permanente, disección precisa mínima traumática, superficie antideslumbrante

Lame saldate al carburo di tungsteno con affilatura a forma di osteotomo e dentellatura micro, rivestimento di ceramica.

Lunga durata di taglio grazie all'alta durezza della superficie. Superficie antiriflesso, dissezione precisa e taglio minimamente traumatizzante



Scheren
Scissors

Ciseaux
Tijeras
Forbici

PRIMUSLINE



METZENBAUM

STANDARD		
140 mm - 5½"	tk 8323-14-A	tk 8333-14-A
150 mm - 6"		tk 8353-15-A
180 mm - 8"	tk 8343-18-A	tk 8353-18-A
200 mm - 8"	tk 8343-20-A	tk 8353-20-A
230 mm - 9"		tk 8353-23-A
SUPERCUT		
140 mm - 5½"	tk 8323-14-B	tk 8333-14-B
150 mm - 6"		tk 8353-15-B
180 mm - 8"	tk 8343-18-B	tk 8353-18-B
200 mm - 8"	tk 8343-20-B	tk 8353-20-B
230 mm - 9"		tk 8353-23-B
TC CUT		
140 mm - 5½"	tk 8323-14-C	tk 8333-14-C
180 mm - 8"	tk 8343-18-C	tk 8353-18-C
200 mm - 8"	tk 8343-20-C	tk 8353-20-C
230 mm - 9"		tk 8353-23-C
CERAMIC SUPERCUT		
140 mm - 5½"	tk 8323-14-E	tk 8333-14-E
180 mm - 8"	tk 8343-18-E	tk 8353-18-E
200 mm - 8"	tk 8343-20-E	tk 8353-20-E
230 mm - 9"		tk 8353-23-E
250 mm - 9¾"		tk 8353-25-E

Scheren | Ciseaux
 Scissors | Tijeras
 Forbici

PRIMUSLINE



1:1



METZENBAUM FINO

<input type="checkbox"/> STANDARD	
140 mm - 5½"	tk 8373-14-A
180 mm - 8"	tk 8381-18-A
200 mm - 8"	tk 8381-20-A
<input checked="" type="checkbox"/> SUPERCUT	
140 mm - 5½"	tk 8373-14-B
180 mm - 8"	tk 8381-18-B
200 mm - 8"	tk 8381-20-B
<input checked="" type="checkbox"/> TC CUT	
140 mm - 5½"	tk 8373-14-C
180 mm - 8"	tk 8381-18-C
200 mm - 8"	tk 8381-20-C
<input checked="" type="checkbox"/> TC SUPERCUT	
180 mm - 8"	tk 8381-18-D
<input checked="" type="checkbox"/> CERAMIC SUPERCUT	
140 mm - 5½"	tk 8373-14-E
180 mm - 8"	tk 8381-18-E
200 mm - 8"	tk 8381-20-E



1:1

BABY METZENBAUM

<input type="checkbox"/> STANDARD	
115 mm - 4½"	tk 8333-11-A
<input checked="" type="checkbox"/> SUPERCUT	
115 mm - 4½"	tk 8333-11-B
<input checked="" type="checkbox"/> TC CUT	
115 mm - 4½"	tk 8333-11-C
<input checked="" type="checkbox"/> TC SUPERCUT	
115 mm - 4½"	tk 8333-11-D
<input checked="" type="checkbox"/> CERAMIC SUPERCUT	
115 mm - 4½"	tk 8333-11-E



1:2

Scheren | Ciseaux
Scissors | Tijeras
Forbici

PRIMUSLINE



1:2



1:1

LEXER

<input type="checkbox"/> STANDARD	
160 mm - 6¼"	tk 8123-16-A
<input checked="" type="checkbox"/> SUPERCUT	
160 mm - 6¼"	tk 8123-16-B
<input checked="" type="checkbox"/> TC CUT	
160 mm - 6¼"	tk 8123-16-C
<input checked="" type="checkbox"/> TC SUPERCUT	
160 mm - 6¼"	tk 8123-16-D
<input checked="" type="checkbox"/> CERAMIC SUPERCUT	
160 mm - 6¼"	tk 8123-16-E



1:2



1:1

MAYO LEXER

<input checked="" type="checkbox"/> TC CUT	
165 mm - 6½"	tk 8125-16-C
<input checked="" type="checkbox"/> TC SUPERCUT	
165 mm - 6½"	tk 8125-16-D
<input checked="" type="checkbox"/> CERAMIC SUPERCUT	
165 mm - 6½"	tk 8125-16-E

Scheren | Ciseaux
 Scissors | Tijeras
 Forbici

PRIMUSLINE



1:2



1:1

MAYO STILLE

<input type="checkbox"/> STANDARD	
170 mm - 6¾"	tk 8283-17-A
<input checked="" type="checkbox"/> SUPERCUT	
170 mm - 6¾"	tk 8283-17-B
<input checked="" type="checkbox"/> TC CUT	
170 mm - 6¾"	tk 8283-17-C
<input checked="" type="checkbox"/> TC SUPERCUT	
170 mm - 6¾"	tk 8283-17-D
<input checked="" type="checkbox"/> CERAMIC SUPERCUT	
170 mm - 6¾"	tk 8283-17-E



1:1

REYNOLDS

<input type="checkbox"/> STANDARD	
140 mm - 5½"	tk 8603-14-A
160 mm - 6¼"	tk 8603-16-A
<input checked="" type="checkbox"/> CERAMIC SUPERCUT	
160 mm - 6¼"	tk 8603-16-E

Scheren | Ciseaux
Scissors | Tijeras
Forbici

PRIMUSLINE



1:2



1:1

JOSEPH

<input type="checkbox"/> STANDARD	
150 mm - 6"	tk 8693-14-A
<input checked="" type="checkbox"/> SUPERCUT	
150 mm - 6"	tk 8693-14-B



1:2



1:1

KELLY

<input type="checkbox"/> STANDARD	
160 mm - 6¼"	tk 8463-16-A
<input checked="" type="checkbox"/> SUPERCUT	
160 mm - 6¼"	tk 8463-16-B
<input checked="" type="checkbox"/> TC CUT	
160 mm - 6¼"	tk 8463-16-C
<input checked="" type="checkbox"/> TC SUPERCUT	
160 mm - 6¼"	tk 8463-16-D
<input checked="" type="checkbox"/> CERAMIC SUPERCUT	
160 mm - 6¼"	tk 8463-16-E

Scheren | Ciseaux
 Scissors | Tijeras
 | Forbici

PRIMUSLINE



1:2



1:1

STEVENS

<input type="checkbox"/> STANDARD	
130 mm - 5"	tk 8463-13-A
<input checked="" type="checkbox"/> SUPERCUT	
130 mm - 5"	tk 8463-13-B

stumpf
 blunt
 mousses
 roma
 smusse



1:2



1:1

IRIS

<input checked="" type="checkbox"/> SUPERCUT	
115 mm - 4½"	tk 9434-11-B
<input checked="" type="checkbox"/> TC SUPERCUT	
115 mm - 4½"	tk 9434-11-C

spitz
 sharp
 pointue
 aguda
 acuta



SUPERCUT

Technische Informationen
Technical information

Information technique
Información técnica
Informazione tecnica

140 mm - 5½"	tk 8198-14	tk 9198-14
140 mm - 5½"	tk 8198-14 SU	tk 9198-14 SU
140 mm - 5½"	tk 8198-14 SUB	tk 9198-14 SUB
140 mm - 5½"	tk 8193-14 TC	tk 9193-14 TC
140 mm - 5½"	tk 8197-14 SU TC	tk 9197-14 SU TC
	gerade <i>straight</i> droits	gebogen <i>curved</i> courbes



standard

Scheren aus rostfreiem Stahl mit Standardschliff für präzises Arbeiten.
Stainless steel scissors with standard cut for precise working.

Ciseaux d'acier inoxydable avec coupe standard pour des travaux précis.
Tijeras de acero inoxidable con corte standard para un trabajo preciso.
Forbici di acciaio inossidabile con filatura Standard per tagli precisi.

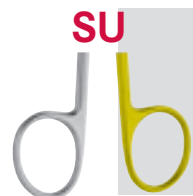

super cut

Messerschliff und Mikroverzahnung für einen feinen minimal traumatisierenden Schnitt.
Knife edges and micro serration for a fine and minimally traumatizing cut.

Aiguisement tranchante et dents micro pour une coupe fine, peu traumatisante.
Hoja de bisturí y dentadura micro para un corte fino, mínimo traumatizante.
Affilatura a scalpello e dentellatura micro per uno taglio fine, minimo traumatizzante.



SUB

super cut

SuperCut Scheren mit schwarzen Griffen.
SuperCut scissors with black handles.

Ciseaux SuperCut avec anneaux noirs
Tijeras SuperCut con anillos negros
Forbici SuperCut con anelli neri

black handle

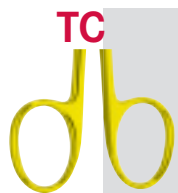

TC
tungsten carbide

Nahtlos aufgeschweisste, korrosionsfreie Hartmetallschneiden.
Seamless welded, corrosion-free tungsten carbide cutting edges.

Plaques en carbure de tungstène, non-corrosives, soudées homogènement dans les lames.
Placas de carburo de tungsteno soldadas homogéneamente y anticorrosiva en las hojas.
Congiunzione omogenea senza cordolo lame saldate al carburo di tungsteno.



SU TC
super cut
tungsten carbide

Nahtlos aufgeschweisste Hartmetallschneide mit Messerschliff und Mikroverzahnung
Tungsten carbide plates, seamlessly welded into the jaws. Knife edges and micro serration.

Plaques en carbure de tungstène, soudées homogènement das les lames. Aiguisement trachante et dents micro.
Placas de carburo de tungsteno soldadas homogéneamente y en las hojas. Hoja de bisturí y dentura micro.
Lame con taglio in tungsteno, senza saldature del morso, con taglio delle lame e dentatura micro.

Chirurgische Scheren
Operating scissors

Ciseaux à chirurgie
Tijeras para cirugía
Forbici per chirurgia



MAYO

145 mm - 5 $\frac{3}{4}$ "	tk 8272-14	tk 8273-14
150 mm - 6 $\frac{3}{4}$ "	tk 8272-15	tk 8273-15
170 mm - 6 $\frac{3}{4}$ "	tk 8272-17	tk 8273-17
230 mm - 9"	tk 8272-23	tk 8273-23
145 mm - 5 $\frac{3}{4}$ "	tk 8272-14 SU	tk 8273-14 SU
150 mm - 6 $\frac{3}{4}$ "	tk 8272-15 SU	tk 8273-15 SU
170 mm - 6 $\frac{3}{4}$ "	tk 8272-17 SU	tk 8273-17 SU
230 mm - 9"	tk 8272-23 SU	tk 8273-23 SU
145 mm - 5 $\frac{3}{4}$ "	tk 8272-14 SUB	tk 8273-14 SUB
150 mm - 6 $\frac{3}{4}$ "	tk 8272-15 SUB	tk 8273-15 SUB
170 mm - 6 $\frac{3}{4}$ "	tk 8272-17 SUB	tk 8273-17 SUB
230 mm - 9"	tk 8272-23 SUB	tk 8273-23 SUB
145 mm - 5 $\frac{3}{4}$ "	tk 8278-14 TC	tk 8279-14 TC
170 mm - 6 $\frac{3}{4}$ "	tk 8278-17 TC	tk 8279-17 TC
230 mm - 9"	tk 8278-23 TC	tk 8279-23 TC

Chirurgische Scheren
Operating scissors

Ciseaux à chirurgie
Tijeras para cirugía
Forbici per chirurgia



1:2



1:1

Fig. 1



1:1

Fig. 2



1:1

Fig. 3

120 mm - 4 $\frac{3}{4}$ "	tk 8523-12	tk 8524-12	tk 8525-12
----------------------------	-------------------	-------------------	-------------------



1:2



1:1

Fig. 1



1:1

Fig. 2



1:1

Fig. 3

120 mm - 4 $\frac{3}{4}$ "	tk 8533-12	tk 8534-12	tk 8535-12
----------------------------	-------------------	-------------------	-------------------

Chirurgische Scheren
Operating scissors

Ciseaux à chirurgie
Tijeras para cirugía
Forbici per chirurgia



LEXER

160 mm - 6 1/4"	tk 8122-16	tk 8123-16
210 mm - 8 1/4"	tk 8122-21	tk 8123-21
160 mm - 6 1/4"	tk 8122-16 SU	tk 8123-16 SU
160 mm - 6 1/4"	tk 8122-16 SUB	tk 8123-16 SUB
160 mm - 6 1/4"	tk 8138-16 TC	tk 8139-16 TC

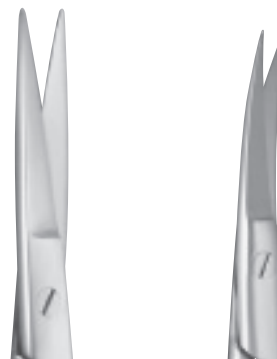

KELLY

160 mm - 6 1/4"	tk 8462-16	tk 8463-16
180 mm - 7"	tk 8462-18	tk 8463-18

Fistel Scheren
Fistula scissors
Ciseaux pour fistules
Tijeras para fistulas
Forbici per fistole

Chirurgische Scheren
Operating scissors

Ciseaux à chirurgie
Tijeras para cirugía
Forbici per chirurgia



1:2



1:1



1:1

PECK-JOSEF

140 mm - 5½"	tk 8198-14	tk 9198-14
140 mm - 5½"	tk 8198-14 SU	tk 9198-14 SU
140 mm - 5½"	tk 8198-14 SUB	tk 9198-14 SUB
140 mm - 5½"	tk 8193-14 TC	tk 9193-14 TC
140 mm - 5½"	tk 8197-14 SU TC	tk 9197-14 SU TC



1:2



1:1



1:1

BROPHY (SULLIVAN)

145 mm - 5¾"	tk 8572-14	tk 8573-14
--------------	-------------------	-------------------

Chirurgische Scheren – Präparierscheren
Operating scissors – Dissecting scissors

Ciseaux à chirurgie – Ciseaux à dissection
Tijeras para cirugía – Tijeras de disección
 Forbici per chirurgia – Forbici per dissezione



METZENBAUM-NELSON

	Fig. 1	Fig. 2	Fig. 3
115 mm – 4½"	tk 8323-11		
145 mm – 5¾"	tk 8323-14	tk 8324-14	tk 8325-14
150 mm – 6"	tk 8343-15		
180 mm – 7"	tk 8343-18	tk 8344-18	tk 8345-18
200 mm – 8"	tk 8343-20	tk 8344-20	tk 8345-20
230 mm – 9"	tk 8343-23	tk 8344-23	tk 8345-23
250 mm – 9¾"	tk 8343-25	tk 8344-25	tk 8345-25
280 mm – 11"	tk 8343-28	tk 8344-28	tk 8345-28
300 mm – 12"	tk 8343-30	tk 8344-30	tk 8345-30
145 mm – 5¾"	tk 8323-14 SU		
180 mm – 7"	tk 8343-18 SU		
200 mm – 8"	tk 8343-20 SU		
230 mm – 9"	tk 8343-23 SU		
145 mm – 5¾"	tk 8323-14 SUB		
180 mm – 7"	tk 8343-18 SUB		
200 mm – 8"	tk 8343-20 SUB		
230 mm – 9"	tk 8343-23 SUB		
115 mm – 4½"	tk 8327-11 TC		
145 mm – 5¾"	tk 8327-14 TC	tk 8328-14 TC	tk 8329-14 TC
180 mm – 7"	tk 8347-18 TC	tk 8348-18 TC	tk 8349-18 TC
200 mm – 8"	tk 8347-20 TC	tk 8348-20 TC	tk 8349-20 TC
230 mm – 9"	tk 8347-23 TC	tk 8348-23 TC	tk 8349-23 TC
250 mm – 9¾"	tk 8347-25 TC		
280 mm – 11"	tk 8347-28 TC		
300 mm – 12"	tk 8347-30 TC		

Chirurgische Scheren – Präparierscheren
Operating scissors – Dissecting scissors

Ciseaux à chirurgie – Ciseaux à dissection
 Tijeras para cirugía – Tijeras de disección
 Forbici per chirurgia – Forbici per dissezione



METZENBAUM-NELSON

	Fig. 1	Fig. 2	Fig. 3
115 mm - 4½"	tk 8333-11		
145 mm - 5¾"	tk 8333-14	tk 8334-14	tk 8335-14
150 mm - 6"	tk 8353-15		
180 mm - 7"	tk 8353-18	tk 8354-18	tk 8356-18
200 mm - 8"	tk 8353-20	tk 8354-20	tk 8356-20
230 mm - 9"	tk 8353-23	tk 8354-23	tk 8356-23
250 mm - 9¾"	tk 8353-25	tk 8354-25	tk 8356-25
280 mm - 11"	tk 8353-28	tk 8354-28	tk 8356-28
300 mm - 12"	tk 8353-30	tk 8354-30	tk 8356-30
145 mm - 5¾"	tk 8333-14 SU		
180 mm - 7"	tk 8353-18 SU		
200 mm - 8"	tk 8353-20 SU		
230 mm - 9"	tk 8353-23 SU		
145 mm - 5¾"	tk 8333-14 SUB		
180 mm - 7"	tk 8353-18 SUB		
200 mm - 8"	tk 8353-20 SUB		
230 mm - 9"	tk 8353-23 SUB		
115 mm - 4½"	tk 8337-11 TC		
145 mm - 5¾"	tk 8337-14 TC	tk 8338-14 TC	tk 8339-14 TC
180 mm - 7"	tk 8357-18 TC	tk 8358-18 TC	tk 8359-18 TC
200 mm - 8"	tk 8357-20 TC	tk 8358-20 TC	tk 8359-20 TC
230 mm - 9"	tk 8357-23 TC	tk 8358-23 TC	tk 8359-23 TC
250 mm - 9¾"	tk 8357-25 TC		
280 mm - 11"	tk 8357-28 TC		
300 mm - 12"	tk 8357-30 TC		

Chirurgische Scheren – Präparierscheren
Operating scissors – Dissecting scissors

Ciseaux à chirurgie – Ciseaux à dissection
Tijeras para cirugía – Tijeras de disección
 Forbici per chirurgia – Forbici per dissezione



METZENBAUM-FINO

	Fig. 1	Fig. 3	Fig. 1	Fig. 3
145 mm – 5¾"	tk 8372-14	tk 8374-14	tk 8373-14	tk 8375-14
180 mm – 7"	tk 8380-18		tk 8381-18	
200 mm – 8"	tk 8380-20		tk 8381-20	
230 mm – 9"	tk 8380-23		tk 8381-23	
<hr/>				
145 mm – 5¾"	tk 8372-14 SU		tk 8373-14 SU	
180 mm – 7"	tk 8380-18 SU		tk 8381-18 SU	
200 mm – 8"	tk 8380-20 SU		tk 8381-20 SU	
230 mm – 9"	tk 8380-23 SU		tk 8381-23 SU	
<hr/>				
145 mm – 5¾"	tk 8372-14 SUB		tk 8373-14 SUB	
180 mm – 7"	tk 8380-18 SUB		tk 8381-18 SUB	
200 mm – 8"	tk 8380-20 SUB		tk 8381-20 SUB	
230 mm – 9"	tk 8380-23 SUB		tk 8381-23 SUB	
<hr/>				
145 mm – 5¾"	tk 8363-14 TC	tk 8366-14 TC	tk 8365-14 TC	tk 8367-14 TC
180 mm – 7"	tk 8370-18 TC		tk 8371-18 TC	
200 mm – 8"	tk 8370-20 TC		tk 8371-20 TC	
230 mm – 9"	tk 8370-23 TC		tk 8371-23 TC	

Irisscheren
Iris scissors

Ciseaux à iridectomie
Tijeras para iridectomia
Forbici per iridectomia



90 mm - 3½"	tk 8642-09	tk 8643-09
115 mm - 4½"	tk 8632-11	tk 8633-11

115 mm - 4½"	tk 8636-11 TC	tk 8637-11 TC
--------------	----------------------	----------------------



90 mm - 3½"	tk 8652-09	tk 8653-09
100 mm - 4"	tk 8652-10	tk 8653-10
115 mm - 4½"	tk 8652-11	tk 8653-11

100 mm - 4"	tk 8652-10 SU	tk 8653-10 SU
-------------	----------------------	----------------------

100 mm - 4"	tk 8652-10 SUB	tk 8653-10 SUB
-------------	-----------------------	-----------------------

Feine Scheren
Fine scissors

Ciseaux fins
Tijeras finas
Forbici fini



STRABISMUS-SCHERE

115 mm - 4½"	tk 9482-11	tk 9483-11
115 mm - 4½"	tk 9482-11 SU	tk 9483-11 SU
115 mm - 4½"	tk 9482-11 SUB	tk 9483-11 SUB

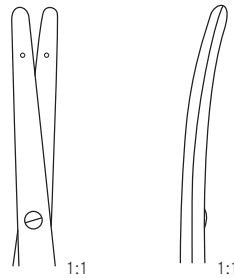

KNAPP

105 mm - 4¼"	tk 8688-10	tk 8689-10
--------------	-------------------	-------------------

stumpf
blunt
mousse
aguda
smusse



GRADLE

90 mm - 3¾"	tk 8694-09
-------------	-------------------

gebogen, spitz
curved, pointed
courbes, pointue
curva, aguda
curve, acuta

Feine Scheren
Fine scissors

Ciseaux fins
Tijeras finas
Forbici fini



QUINBY
125 mm - 5" **tk 8592-12**



1:1

1:2



NEUMANN
120 mm - 4 3/4" **tk 8597-12**

S-förmig gebogen
S curved
courbe en S
curva en S
curve a forma di S

1:2

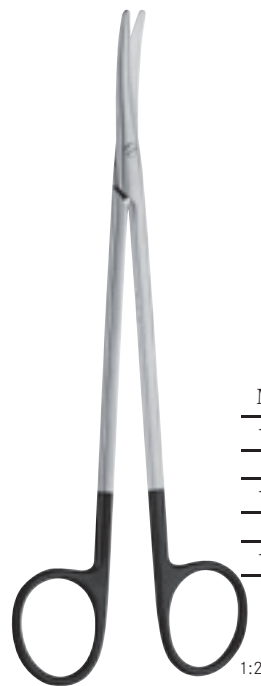

MC INDOE
180 mm - 7" **tk 8352-18**
180 mm - 7" **tk 8352-18 SU**
180 mm - 7" **tk 8352-18 SUB**



1:2

1:2

Kurzes Maul
Short jaw
Mors court
Boca corta
Taglio corto



LOCKLIN
165 mm - 6 1/2" **tk 8582-16** **tk 8587-16**

gerade, gezahnt
straight, saw edge
droit, dentelée
recta, dentada
rette, dentate

gebogen, gezahnt
curved, saw edge
courbe, dentelée
curva, dentada
curve, dentate

1:2

1:2

Feine chirurgische Scheren
Fine operating scissors

Ciseaux fins à chirurgie
Tijeras finas para cirugía
Forbici fine per chirurgia



CONVERSE

100 mm - 3 3/4"

tk 9203-10

aufgewinkelt
angled
courbe vers le haut
angulado
angulato



BEUSE

115 mm - 5"



leicht gebogen, spitz
slightly curved, pointed
légèrement courbe,
pointues
ligeramente curve, aguda
legeramente curve, acuta

leicht gebogen, stumpf
slightly curved, blunt
légèrement courbe,
mousses
ligeramente curva, roma
legeramente curve, smusso



1:1

1:1

RIBBON STEVENS

95 mm - 3 3/4"

tk 9456-10

tk 9454-10

spitz - spitz
sharp - sharp
pointue - pointue
aguda - aguda
acuta - acuta



1:1

1:1

RIBBON STEVENS

95 mm - 3 3/4"

tk 9457-10

tk 9455-10

stumpf - stumpf
blunt - blunt
mousse - mousse
roma - roma
smussa - smussa



Sehnenscheren
Tenotomy scissors

Ciseaux à ténatomie
Tijeras para tenotomia
Forbici per tenotomia



STEVENS

100 mm - 4"	tk 9452-10	tk 9453-10
110 mm - 4 1/4"	tk 9452-11	tk 9453-11
100 mm - 4"	tk 9452-10 SU	tk 9453-10 SU
110 mm - 4 1/4"	tk 9452-11 SU	tk 9453-11 SU
100 mm - 4"	tk 9452-10 SUB	tk 9453-10 SUB
110 mm - 4 1/4"	tk 9452-11 SUB	tk 9453-11 SUB

spitz - spitz
sharp - sharp
pointue - pointue
aguda - aguda
acuta - acuta



STEVENS

100 mm - 4"	tk 9462-10	tk 9463-10
110 mm - 4 1/4"	tk 9462-11	tk 9463-11
100 mm - 4"		tk 9463-10 SU
110 mm - 4 1/4"		tk 9463-11 SU
100 mm - 4"		tk 9463-10 SUB
110 mm - 4 1/4"		tk 9463-11 SUB

stumpf - stumpf
blunt - blunt
mousse - mousse
roma - roma
smussa - smussa

Scheren für plastische Operationen
Plastic surgery scissors

Ciseaux pour la chirurgie plastique
Tijeras para cirugía plástica
Forbici per chirurgia plastica



REYNOLDS (JAMESON)

160 mm - 6 1/4"	tk 8602-16	tk 8603-16
180 mm - 7"	tk 8602-18	tk 8603-18
160 mm - 6 1/4"	tk 8602-16 SU	tk 8603-16 SU
180 mm - 7"	tk 8602-18 SU	tk 8603-18 SU
160 mm - 6 1/4"	tk 8602-16 SUB	tk 8603-16 SUB
180 mm - 7"	tk 8602-18 SUB	tk 8603-18 SUB



KILNER (RAGNELL)

120 mm - 4 3/4"	tk 8697-12
150 mm - 6"	tk 8697-15
120 mm - 4 3/4"	tk 8697-12 SU
150 mm - 6"	tk 8697-15 SU
180 mm - 7"	tk 8697-18 SU
200 mm - 8"	tk 8697-20 SU
120 mm - 4 3/4"	tk 8697-12 SUB
150 mm - 6"	tk 8697-15 SUB
180 mm - 7"	tk 8697-18 SUB
200 mm - 8"	tk 8697-20 SUB
120 mm - 4 3/4"	tk 8698-12 TC
150 mm - 6"	tk 8698-15 TC

Scheren für plastische Operationen
Plastic surgery scissors

Ciseaux pour la chirurgie plastique
Tijeras para cirugía plástica
Forbici per chirurgia plastica



1:2



1:1



1:1

JOSEPH

140 mm - 5 1/2"	tk 8692-14	tk 8693-14
-----------------	-------------------	-------------------



1:2



1:2

GORNEY

180 mm - 7 1/4"	tk 8704-18 SU	tk 8705-18 SU
230 mm - 9"	tk 8704-23 SU	tk 8705-23 SU
180 mm - 7 1/4"	tk 8704-18 SUB	tk 8705-18 SUB
230 mm - 9"	tk 8704-23 SUB	tk 8705-23 SUB
190 mm - 7 1/2"	tk 8702-20 TC	tk 8703-20 TC
230 mm - 9"	tk 8702-23 TC	tk 8703-23 TC

Scheren für plastische Operationen
Plastic surgery scissors

Ciseaux pour la chirurgie plastique
Tijeras para cirugía plástica
 Forbici per chirurgia plastica

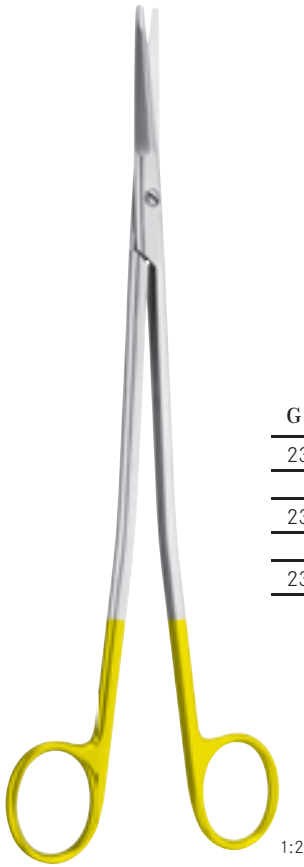

1:2



1:2



1:2

GORNEY PLATYSMA

230 mm - 9"	tk 9186-23 SU	tk 9185-23 SU
230 mm - 9"	tk 9186-23 SUB	tk 9185-23 SUB
230 mm - 9"	tk 9170-23 TC	tk 9171-23 TC



1:2

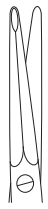

1:2



1:2

GORNEY-FREEMAN

190 mm - 7½"	tk 9168-19	tk 9167-19
190 mm - 7½"	tk 9168-19 SU	tk 9169-19 SU
190 mm - 7½"	tk 9168-19 SUB	tk 9169-19 SUB
190 mm - 7½"	tk 9170-19 TC	tk 9171-19 TC
190 mm - 7½"	tk 9172-19 SU TC	tk 9173-19 SU TC

Scheren für plastische Operationen
Plastic surgery scissors

Ciseaux pour la chirurgie plastique
Tijeras para cirugía plástica
Forbici per chirurgia plastica



GORNEY-DELICATE

205 mm - 8 1/4"	tk 9163-20 SU
205 mm - 8 1/4"	tk 9163-20 SUB
205 mm - 8 1/4"	tk 9164-20 TC
205 mm - 8 1/4"	tk 9165-20 SU TC

gebogen
curved
courbe
curva
curve

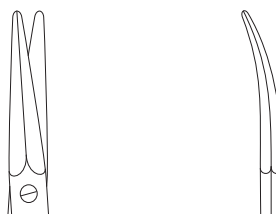

KAYE

145 mm - 5 3/4"	tk 9174-14 SU	tk 9175-14 SU
185 mm - 7"	tk 9174-18 SU	tk 9175-18 SU
230 mm - 9"	tk 9176-23 SU	tk 9177-23 SU
145 mm - 5 3/4"	tk 9174-14 SUB	tk 9175-14 SUB
185 mm - 7"	tk 9174-18 SUB	tk 9175-18 SUB
230 mm - 9"	tk 9176-23 SUB	tk 9177-23 SUB
145 mm - 5 3/4"	tk 9174-14 TC	tk 9175-14 TC
185 mm - 7"	tk 9174-18 TC	tk 9175-18 TC
230 mm - 9"	tk 9176-23 TC	tk 9177-23 TC
145 mm - 5 3/4"	tk 9178-14 SU TC	tk 9179-14 SU TC
185 mm - 7"	tk 9178-18 SU TC	tk 9179-18 SU TC
230 mm - 9"	tk 9178-23 SU TC	tk 9179-23 SU TC

Scheren für plastische Operationen
Plastic surgery scissors

Ciseaux pour la chirurgie plastique
Tijeras para cirugía plástica
Forbici per chirurgia plastica

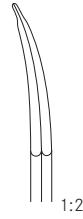
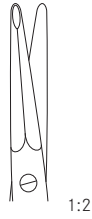

FREEMAN-KAYE

185 mm - 7"	tk 9182-18 SU	tk 9183-18 SU
185 mm - 7"	tk 9182-18 SUB	tk 9183-18 SUB
185 mm - 7"	tk 9172-18 TC	tk 9173-18 TC
185 mm - 7"		tk 9183-18 SU TC



AUFRICHT

150 mm - 5¾"	tk 8706-15 SU	tk 8707-15 SU
150 mm - 5¾"	tk 8706-15 SUB	tk 8707-15 SUB

Scheren für plastische Operationen
Plastic surgery scissors

Ciseaux pour la chirurgie plastique
Tijeras para cirugía plástica
Forbici per chirurgia plastica



K A H N

145 mm - 5½"	tk 8154-14	tk 8155-14
180 mm - 7"	tk 8154-18	tk 8155-18



1:2



1:2

G O L D M A N - F O X

130 mm - 5"	tk 9922-13	tk 9923-13
130 mm - 5"	tk 9922-13 SU	tk 9923-13 SU
130 mm - 5"	tk 9922-13 SUB	tk 9923-13 SUB
130 mm - 5"	tk 9924-13 SU TC	tk 9925-13 SU TC

1:2

Face-Lift-Scheren
Face-lift scissors

Ciseaux pour le face-lift
Tijeras para el face-lift
Forbici per "face-lifting"

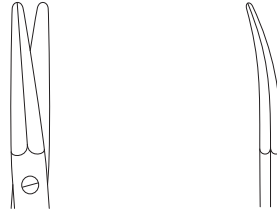

REES

170 mm - 6 $\frac{3}{4}$ "	tk 9182-17	tk 9183-17
205 mm -	tk 9182-20	tk 9183-20
170 mm - 6 $\frac{3}{4}$ "	tk 9182-17 SU	tk 9183-17 SU
205 mm -	tk 9182-20 SU	tk 9183-20 SU
170 mm - 6 $\frac{3}{4}$ "	tk 9182-17 SUB	tk 9183-17 SUB
205 mm -	tk 9182-20 SUB	tk 9183-20 SUB
170 mm - 6 $\frac{3}{4}$ "	tk 9192-17 TC	tk 9193-17 TC
205 mm -	tk 9192-20 TC	tk 9193-20 TC



REES BULLDOG

130 mm - 5"

tk 9199-13

leicht gebogen
slightly curved

légèrement courbe
ligeramente curva
legermente curve

1:2



1:2

DAVIS

170 mm - 6 $\frac{3}{4}$ "

tk 9191-18

170 mm - 6 $\frac{3}{4}$ "

tk 9191-18 SU

170 mm - 6 $\frac{3}{4}$ "

tk 9191-18 SUB

Face-Lift-Scheren
Face-lift scissors

Ciseaux pour le face-lift
Tijeras para el face-lift
Forbici per "face-lifting"



1:2



1:1



1:1

CASTANARES

160 mm - 6 1/4"	tk 9208-16	tk 9209-16
160 mm - 6 1/4"	tk 9210-16 TC	



1:2

GREGORY

145 mm - 5 1/2"	tk 9196-14 TC
-----------------	----------------------

leicht gebogen
slightly curved
légèrement courbe
ligeramente curva
legermente curve

Nasenscheren
Nasal scissors

Ciseaux nasaux
Tijeras nasales
Forbici nasali



KNIGHT
180 mm - 7" **tk 9205-18**

gewinkelt
angled
angulée
angulado
angulato

1:2



FOMON
135 mm - 5 1/4" **tk 8392-14**

135 mm - 5 1/4" **tk 8392-14 SU**

135 mm - 5 1/4" **tk 8392-14 SUB**

stark gebogen
strongly curved
fortement courbe
fuertemente curva
fortamente curve

1:2



BOETTCHER
180 mm - 7" **tk 8832-18**

1:2



THOREK
190 mm - 7 1/2" **tk 8394-19**

1:2

Augenscheren
Blepharoplasty scissors

Ciseaux pour blépharoplastie
Tijeras para blefaroplastica
Forbici per blefaroplastica



1:1



1:1

S H E A

120 mm - 4 3/4"	tk 9208-12	tk 9209-12
120 mm - 4 3/4"	tk 9208-12 SU	tk 9209-12 SU
120 mm - 4 3/4"	tk 9208-12 SUB	tk 9209-12 SUB

spitz
pointed
pointue
aguda
acuta

1:2



1:1



1:1

B O N N

80 mm - 3 1/4"	tk 9211-09	tk 9212-09
----------------	-------------------	-------------------

1:2

Augenscheren
Blepharoplasty scissors

Ciseaux pour blépharoplastie
Tijeras para blefaroplastica
Forbici per blefaroplastica



PAR-TYPE

115 mm - 4½"	tk 8188-11	tk 8189-11
145 mm - 5¾"	tk 8188-14	tk 8189-14
115 mm - 4½"	tk 8188-11 SU	tk 8189-11 SU
145 mm - 5¾"	tk 8188-14 SU	tk 8189-14 SU
115 mm - 4½"	tk 8188-11 SUB	tk 8189-11 SUB
145 mm - 5¾"	tk 8188-14 SUB	tk 8189-14 SUB
115 mm - 4½"	tk 9188-11 TC	tk 9189-11 TC
145 mm - 5¾"	tk 9188-14 TC	tk 9189-14 TC
115 mm - 4½"	tk 9188-11 SU TC	tk 9189-11 SU TC
145 mm - 5¾"	tk 9188-14 SU TC	tk 9189-14 SU TC

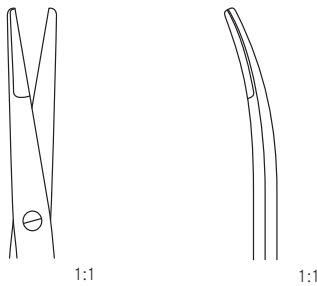

GREENBERG PAR

115 mm - 4½"	tk 9198-11	tk 9199-11
115 mm - 4½"	tk 9198-11 SU	tk 9199-11 SU
115 mm - 4½"	tk 9198-11 SUB	tk 9199-11 SUB
115 mm - 4½"	tk 9200-11 TC	tk 9201-11 TC
115 mm - 4½"	tk 9200-11 SU TC	tk 9201-11 SU TC

Augenscheren
Blepharoplasty scissors

Ciseaux pour blépharoplastie
Tijeras para blefaroplastica
Forbici per blefaroplastica



1:1



1:1

KAYE BLEPHAROPLASTY

115 mm - 4 1/2"	tk 8134-11	tk 8135-11
115 mm - 4 1/2"	tk 8134-11 SU	tk 8135-11 SU
115 mm - 4 1/2"	tk 8134-11 SUB	tk 8135-11 SUB
115 mm - 4 1/2"	tk 9134-11 TC	tk 9135-11 TC
115 mm - 4 1/2"	tk 9134-11 SU TC	tk 9135-11 SU TC



1:1



1:1

KAYE RIBBON TYPE

115 mm - 4 1/2"	tk 9179-11	tk 9180-11
-----------------	-------------------	-------------------

Mikro-Federscheren
Micro-scissors

Micro ciseaux à ressorts
Micro tijeras con resorte
Forbici per microchirurgia

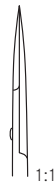
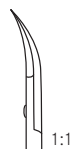
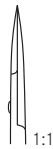
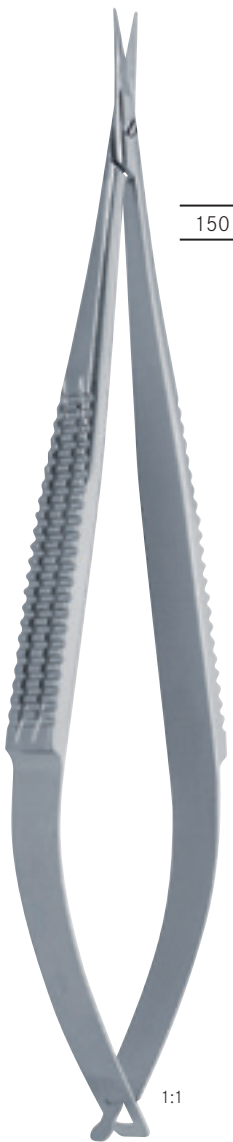

150 mm - 6"	tk 25670-15	tk 25671-15	tk 25672-15	tk 25673-15
	gerade, kurze Schneide <i>straight, short blades</i> droite, lames courtes <i>recta, hojas cortas</i> retta, lama corta	gebogen, kurze Schneide <i>curved, short blades</i> courbe, lames courtes <i>curva, hojas cortas</i> curva, lama corta	gerade, lange Schneide <i>straight, long blades</i> droite, lames longues <i>recta, hojas largas</i> retta, lama lunga	gebogen, lange Schneide <i>curved, long blades</i> courbe, lames longues <i>curva, hojas largas</i> curva, lama lunga

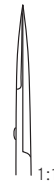

150 mm - 6"	tk 25678-15	tk 25679-15
	gerade, gezahnt <i>straight, saw edge</i> droite, dentelée <i>recta, dentadas</i> retta, dentata	gebogen, gezahnt <i>curved, saw edge</i> courbe, dentelée <i>curva, dentadas</i> curva, dentata

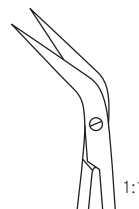

150 mm - 6"	tk 25675-15
180 mm - 7"	tk 25677-18
	kniegebogen, 45° <i>angled on flat, 45°</i> angulaire, 45° <i>acodada, 45°</i> angolata, 45°

Mikro-Präparierscheren
Micro dissecting scissors

Micro ciseaux à dissection
Micro tijeras de disección
Forbici per micro chirurgia con manico rotondo

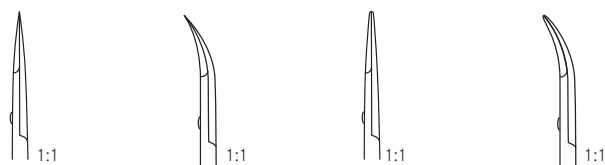

145 mm - 5¾"	tk 25602-01	tk 25603-01	tk 25602-02	tk 25603-02
180 mm - 7"	tk 25610-01	tk 25611-01	tk 25610-02	tk 25611-02

kurze Schneide 8 mm, glatt
short blades 8 mm, smooth
lames courtes 8 mm, lisses
hojas cortas 8 mm, lisos
lama corta 8 mm, liscia

gerade, spitz
straight, sharp
droites, pointues
rectas, agudas
retta, acuta

gebogen, spitz
curved, sharp
courbes, pointues
curvas, agudas
curva, acuta

gerade, stumpf
straight, blunt
droites, mousses
rectas, romas
retta, smussa

gebogen, stumpf
curved, blunt
courbes, mousses
curvas, romas
curva, smussa

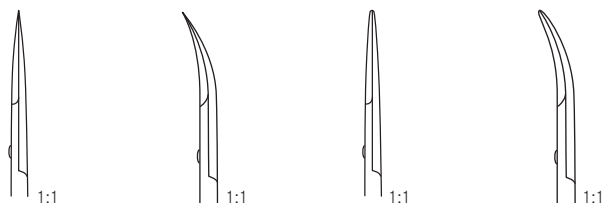

145 mm - 5¾"	tk 25602-03	tk 25603-03	tk 25602-04	tk 25603-04
180 mm - 7"	tk 25610-03	tk 25611-03	tk 25610-04	tk 25611-04

lange Schneide 14 mm, glatt
long blades 14 mm, smooth
lames longues 14 mm, lisses
hojas largas 14 mm, lisos
lama lunga 14 mm, liscia

gerade, spitz
straight, sharp
droites, pointues
rectas, agudas
retta, acuta

gebogen, spitz
curved, sharp
courbes, pointues
curvas, agudas
curva, acuta

gerade, stumpf
straight, blunt
droites, mousses
rectas, romas
retta, smussa

gebogen, stumpf
curved, blunt
courbes, mousses
curvas, romas
curva, smussa

Mikroscheren mit Rundgriff
Micro scissors with round handle

Micro ciseaux avec manche ronde
Micro tijeras con mango redondo
 Forbici per micro chirurgia con manico rotondo

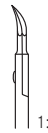
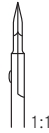

VANNAS

	7 mm Ø	7 mm Ø
120 mm - 5"	tk 25612-12	tk 25613-12

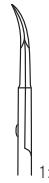
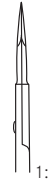

VANNAS

	8 mm Ø	8 mm Ø
150 mm - 6"	tk 25600-15	tk 25601-15

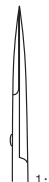

CASTROVIEJO

	8 mm Ø	8 mm Ø
150 mm - 6"	tk 25610-15	tk 25611-15

Mikroscheren mit Rundgriff
Micro scissors with round handle

Micro ciseaux avec manche ronde
Micro tijeras con mango redondo
 Forbici per micro chirurgia con manico rotondo

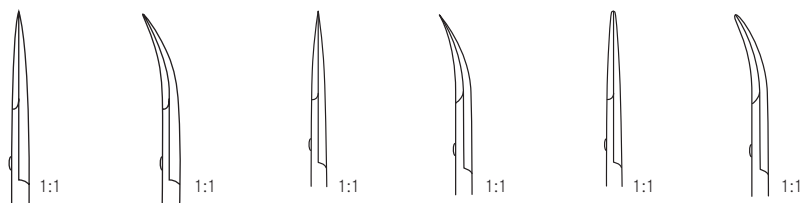

	180 mm - 7"	180 mm - 7"	180 mm - 7"	180 mm - 7"	180 mm - 7"	180 mm - 7"
8 mm Ø	tk 25606-18	tk 25607-18				
10 mm Ø	tk 25602-18	tk 25603-18	tk 25618-18	tk 25619-18	tk 25620-18	tk 25621-18

Anatomische Pinzetten - Chirurgische Pinzetten
Dressing forceps - Dissecting forceps

Pinces à dissection - Pinces à dissection à griffes
Pinzas de disección - Pinzas de disección con dientes
 Pinze per dissezione - Pinze per dissezione con denti



SEMKEN

125 mm - 5"	tk 10300-12	tk 11300-12
150 mm - 6"	tk 10300-15	tk 11300-15

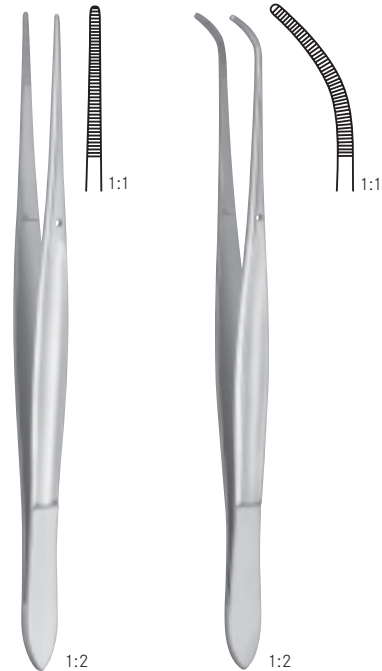

CUSHING

175 mm - 7"	tk 10400-17	tk 10401-17
175 mm - 7"	tk 10402-17 TC	

Anatomische Pinzetten - Chirurgische Pinzetten
Dressing forceps - Dissecting forceps

Pinces à dissection - Pinces à dissection à griffes
 Pinzas de disección - Pinzas de disección con dientes
 Pinze per dissezione - Pinze per dissezione con denti



GILLIES
 150 mm - 6"
tk 11250-15



MC INDOE
 150 mm - 6" **tk 10550-15**
 150 mm - 6" **tk 11640-15 TC**



WANGENSTEEN
 150 mm - 6" **tk 10608-15**
 230 mm - 9" **tk 10608-23**

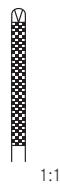

OEHLER

140 mm - 5½"	160 mm - 6¼"	180 mm - 7"
tk 11690-14 TC	tk 11690-16 TC	tk 11690-18 TC



200 mm - 8"	250 mm - 9¾"	300 mm - 12"
tk 11690-20 TC	tk 11690-25 TC	tk 11690-30 TC

Anatomische Pinzetten - Chirurgische Pinzetten
Dressing forceps - Dissecting forceps

Pinces à dissection - Pinces à dissection à griffes
Pinzas de disección - Pinzas de disección con dientes
 Pinze per dissezione - Pinze per dissezione con denti

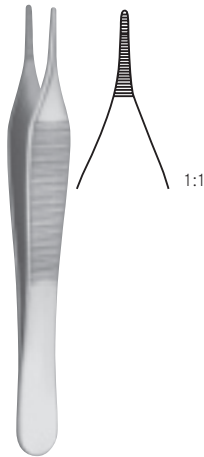

ADSON

120 mm - 4¾"	tk 10500-12
150 mm - 6"	tk 10500-15
120 mm - 4¾"	tk 10502-12 TC
150 mm - 6"	tk 10502-15 TC



MICRO-ADSON

120 mm - 4¾"	tk 10503-12
150 mm - 6"	tk 10503-15



ADSON-GRAEFE

120 mm - 4¾"	tk 11212-12
--------------	--------------------



ADSON BROWN

120 mm - 4¾"	tk 11210-12
120 mm - 4¾"	tk 10508-12 TC

Anatomische Pinzetten - Chirurgische Pinzetten
Dressing forceps - Dissecting forceps

Pinces à dissection - Pinces à dissection à griffes
 Pinzas de disección - Pinzas de disección con dientes
 Pinze per dissezione - Pinze per dissezione con denti



ADSON

120 mm - 4 3/4"	tk 11200-12	tk 11204-12
150 mm - 6"	tk 11200-15	
120 mm - 4 3/4"	tk 10504-12 TC	
150 mm - 6"	tk 10504-15 TC	

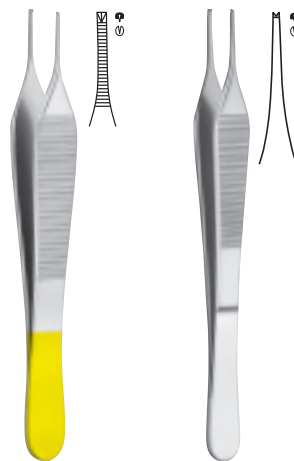

MICRO-ADSON

tk 11202-12	tk 11206-12
tk 11202-15	tk 11206-15
tk 10506-12 TC	
tk 10506-15 TC	



ADSON

120 mm - 4 3/4"
tk 11206-13
mit Fadenplatte 1 mm with tying platform 1 mm
avec plateforme pour sutures 1 mm con plataforma para suturas 1 mm con piattaforma per suture 1 mm



**ULTRA-MICRO-ADSON
(BRAKA)**

120 mm - 4 3/4"
tk 11206-12B
mit Fadenplatte 1 mm with tying platform 1 mm
avec plateforme pour sutures 1 mm con plataforma para suturas 1 mm con piattaforma per suture 1 mm

Anatomische Pinzetten - Chirurgische Pinzetten
Dressing forceps - Dissecting forceps

Pincas à dissection - Pincas à dissection à griffes
Pinzas de disección - Pinzas de disección con dientes
Pinze per dissezione - Pinze per dissezione con denti



GRAEFE

105 mm - 4 1/4"

tk 11700-10

tk 11701-10

tk 11703-10

tk 11730-10

tk 11731-10

tk 11733-10

Anatomische Pinzetten - Chirurgische Pinzetten
Dressing forceps - Dissecting forceps

Pinces à dissection - Pinces à dissection à griffes
Pinzas de disección - Pinzas de disección con dientes
 Pinze per dissezione - Pinze per dissezione con denti



ADLERKREUTZ

150 mm - 6"	tk 11086-15	tk 11087-15
200 mm - 8"	tk 11086-20	tk 11087-20
250 mm - 9¾"		tk 11087-25



WAUGH

150 mm - 6"	tk 10616-15
200 mm - 8"	tk 10616-20
250 mm - 9¾"	tk 10616-25



DUEHRSEN

200 mm - 8"

tk 10604-20



105 mm - 4¼"

tk 11635-10

Columella Pinzette
Columella forceps

Pince à columella
Pinza para columella
 Pinze per columella

Anatomische Pinzetten - Chirurgische Pinzetten
Dressing forceps - Dissecting forceps

Pinces à dissection - Pinces à dissection à griffes
Pinzas de disección - Pinzas de disección con dientes
 Pinze per dissezione - Pinze per dissezione con denti



POTTS-SMITH

180 mm - 7"	tk 11150-18	tk 11151-18
210 mm - 8¼"	tk 11150-21	tk 11151-21
250 mm - 9¾"	tk 11150-25	tk 11151-25



BROPHY

200 mm - 8"	tk 11100-20	tk 11101-20
-------------	--------------------	--------------------

Anatomische Pinzetten - Chirurgische Pinzetten
Dressing forceps - Dissecting forceps

Pinces à dissection - Pinces à dissection à griffes
 Pinzas de disección - Pinzas de disección con dientes
 Pinze per dissezione - Pinze per dissezione con denti



TAYLOR

175 mm - 7"

tk 10310-17

tk 10312-17

tk 10313-17



GERALD

180 mm - 7"

tk 10324-18

tk 10325-18

tk 10326-19

Atraumatische Pinzetten
Atraumatic tissue forceps

Pinces atraumatiques
Pinzas de disección atraumáticas
Pinze per dissezione atraumatiche

ATRAUMTK



DE BAKEY-GERALD	
150 mm - 6"	tk 10327-15
180 mm - 7"	tk 10327-18





DE BAKEY BAYONET	
180 mm - 7"	tk 10328-18
200 mm - 8"	tk 10328-20

Atraumatische Pinzetten
Atraumatic tissue forceps

Pinces atraumatiques
 Pinzas de disección atraumáticas
 Pinze per dissezione atraumatiche

ATRAUMTK



DE BAKEY		
	x = 1.5 mm	x = 2.0 mm
120 mm - 4¾"	tk 11960-12	
145 mm - 5¾"	tk 11960-14	tk 11964-14
160 mm - 6¼"	tk 11960-16	tk 11964-16
200 mm - 8"	tk 11960-20	tk 11964-20
240 mm - 9½"	tk 11960-24	tk 11964-24
300 mm - 12"		tk 11964-30

Atraumatische Pinzetten
Atraumatic tissue forceps

Pinces atraumatiques
Pinzas de disección atraumáticas
Pinze per dissezione atraumatiche

TUCAR**TK**

ATRAUM**TK**



DE B A K E Y

	x = 1.5 mm	x = 2.0 mm
150 mm - 6"	tk 11968-15 TC	tk 11969-15 TC
190 mm - 7½"	tk 11968-19 TC	tk 11969-19 TC
240 mm - 9½"	tk 11968-24 TC	tk 11969-24 TC

Mikro-Pinzetten
Micro forceps

Pinces micro
Micro pinzas
Micro pinze



	x = 0.3 mm	x = 0.5 mm
150 mm - 6"	tk 25686-30	
180 mm - 7"		tk 25686-35

mit Fadenplatte
with tying platform

avec plateforme pour sutures
con plataforma para suturas
con piattaforma per suture



	x = 0.3 mm	x = 0.5 mm
150 mm - 6"	tk 25687-30	
180 mm - 7"		tk 25687-335

mit Fadenplatte
with tying platform

avec plateforme pour sutures
con plataforma para suturas
con piattaforma per suture

Mikro-Pinzetten
Micro forceps

Pinces micro
Micro pinzas
Micro pinze



TYP
JUWELIER

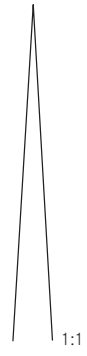
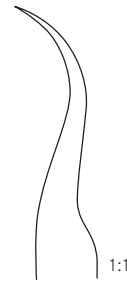
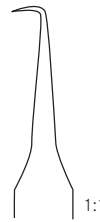
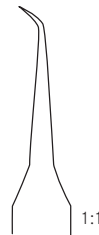

x = 0.2 mm	x = 0.3 mm	x = 0.3 mm	x = 0.2 mm	x = 0.3 mm
110 mm - 4¼"	110 mm - 4¼"	110 mm - 4¼"	120 mm - 4¾"	120 mm - 4¾"
tk 26001-11	tk 26002-11	tk 26003-11	tk 26005-12	tk 26006-13

Mikro-Pinzetten
Micro forceps

Pinces micro
Micro pinzas
Micro pinze



PIERSE

120 mm - 4 ³ / ₄ "	tk 26009-12
135 mm - 5 "	tk 26009-13

Gefäßdilatoren
Vessel dilators

Dilatateurs vasculaires
Dilatadores vasculares
Dilatatori vascolari

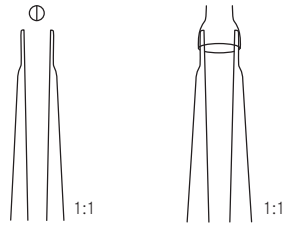

	x = 0.2 mm	x = 0.3 mm
110 mm - 4 1/4"	tk 26015-02	tk 26015-03

sehr fein
very fine
très fin
muy fino
molto fino



	x = 0.3 mm
150 mm - 6"	tk 26015-04
180 mm - 7"	tk 26015-05

mit Fadenplatte
with tying platform
avec plateforme pour sutures
con plataforma para suturas
con piattaforma per suture

Approximatoren, Gefäßclips nach Biemer
Approximators, Biemer clips

Approximateurs, clips selon Biemer
Approximadores, Biemer clips
Approssimatori, clips vascolari Biemer



1:3

BIEMER

	tk 25209-02	tk 25209-01
	Anlegepinzette mit Schloss <i>applying forceps with lock</i> pince à poser avec verrou <i>aplicadora con cierre</i> pinza posa clips con cremagliera	Anlegepinzette ohne Schloss <i>applying forceps without lock</i> pince à poser sans verrou <i>aplicadora sin cierre</i> pinza posa clips senza cremagliera



	x	y	gms
	Maullänge <i>jaw length</i> longueur du mors <i>longitud de la boca</i> lunghezza del morso	max. Maulöffnung <i>max. jaw opening</i> ouverture max. du mors <i>apertura max. de la boca</i> apertura mass.	Schließkraft <i>closing pressure</i> force de fermeture <i>fuerza de cierre</i> pressione

tk 25210-00	tk 25211-00	tk 25212-00	tk 25213-00
--------------------	--------------------	--------------------	--------------------

x = 6 mm
y = 4 mm
30 gms - 40 gms

x = 9 mm
y = 5 mm
30 gms - 40 gms

x = 9 mm
y = 5 mm
20 gms - 25 gms

x = 4,5 mm
y = 3,0 mm
30 gms - 40 gms

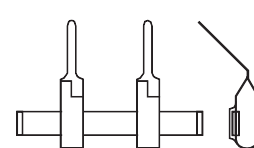
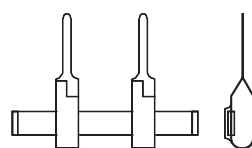
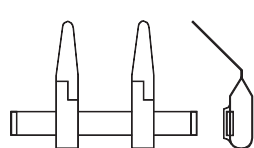
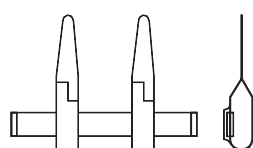

tk 25214-00	tk 25215-00	tk 25216-00	tk 25217-00
--------------------	--------------------	--------------------	--------------------

x = 9 mm
y = 5 mm
30 gms - 40 gms

x = 9 mm
y = 5 mm
30 gms - 40 gms

x = 9 mm
y = 5 mm
20 gms - 25 gms

x = 9 mm
y = 5 mm
30 gms - 40 gms

Für temporären Gebrauch, (gekennzeichnet durch gelb eingefärbte Federenden) für Gefäße mit 0,5 mm - 2,0 mm Ø. Maulinnenflächen schräg gerieft für schonendes und sicheres Festhalten der Gefäße. Der fest eingestellte Schliessdruck gewährt risikofreie Anwendung

For temporary occlusion, (identified by yellow coloured spring ends) for vessels of 0,5 mm - 2,0 mm Ø. Blade gripping surface with oblique serrations for save but careful gripping of vessels. No risk due to rigidly fixed pressure measure

Pour usage temporaire, (ressorts couleur jaune) pour vaisseau de 0,5 mm - 2,0 mm Ø. Mors striés pour fixation sûr et menagement. Force du fermeture non changeable

Para oclusión temporal (ressortes amarillos) para vasos de 0,5 mm - 2,0 mm Ø. Boca estriada para fijación segura y moderada de los vasos. Utilización sin riesgo con fuerza de oclusión fija

Per uso temporaneo, con finale della molla giallo, per vasi di 0,5 mm - 2,0 mm Ø. Morso zignanto per una presa sicura, non traumatica

Anlegepinzetten für Gefäßclips
Applying forceps for vessel clips
Pinces à poser des clips
Aplicadoras para clips
Pinze per mettere clips

140 mm - 5½"	tk 25059-01	tk 25059-02
--------------	--------------------	--------------------

ohne Schloß <i>without lock</i>	mit Schloß <i>with lock</i>
sans serrure <i>sin cierre</i>	avec serrure <i>con cierre</i>
senza cremagliera	con cremagliera



140 mm - 5½"	tk 25059-03
--------------	--------------------

für Approximatoren und Doppelklemmen
for approximators and double-clips
 pour approximateurs et clips doubles
para aproximadores y clips dobles
 per approssimatori e clips doppi

x	Ø	V	A
Länge <i>Length</i>	Gefäß <i>Vessel</i>	Vene <i>Vein</i>	Arterie <i>Artery</i>
Longueur	Vaisseau	Veine	Artère
<i>Longitud</i>	Vaso	Vena	Arteria
Lunghezza	Vaso	Vena	Arteria

Weitere Modelle und Ausführungen auf Anfrage
Other models and executions upon request
 Autres modèles et exécutions sur demande
Otros modelos y ejecuciones segun demanda
 Altri modelli a richiesta















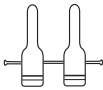

50 x 25 x 4.5 mm	75 x 25 x 4.5 mm	70 x 45 x 8 mm
tk 55210-01	tk 55210-02	tk 55210-03

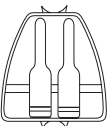
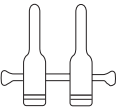
Lagerungstrays für Gefäßclips
Trays for storage of vessel clips

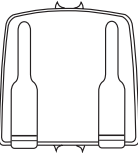
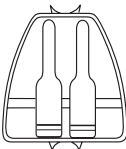
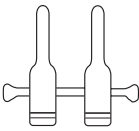
 Boîtes pour clips vasculaires
Cajas para clips vasculares
 Scatole per clips vascolari

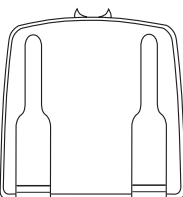
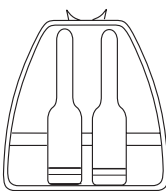
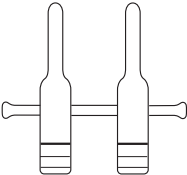
Approximatoren, Gefäßclips
Approximators, clips

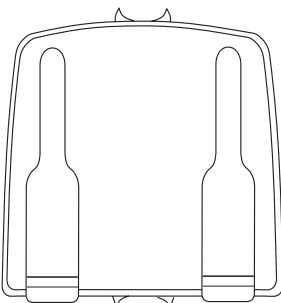
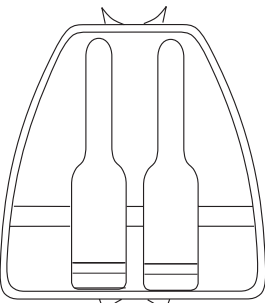
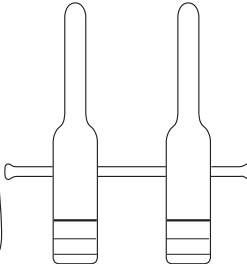
Approximateurs, clips
Approximadores, clips
Approssimatori, clips vascolari

x = 8 mm				
V	tk 25060-01	tk 25060-02	tk 25060-03	tk 25060-04
A	tk 25070-01	tk 25070-02	tk 25070-03	tk 25070-04
Ø = 0,4 mm - 1 mm				
x = 11 mm				
V	tk 25061-01	tk 25061-02	tk 25061-03	tk 25061-04
A	tk 25071-01	tk 25071-02	tk 25071-03	tk 25071-04
Ø = 0,6 mm - 1,5 mm				
x = 14 mm				
V	tk 25062-01	tk 25062-02	tk 25062-03	tk 25062-04
A	tk 25072-01	tk 25072-02	tk 25072-03	tk 25072-04
Ø = 1 mm - 2 mm				
x = 17 mm				
V	tk 25063-01	tk 25063-02	tk 25063-03	tk 25063-04
A	tk 25073-01	tk 25073-02	tk 25073-03	tk 25073-04
Ø = 1 mm - 2,25 mm				
x = 25 mm				
V	tk 25064-01	tk 25064-02	tk 25064-03	tk 25064-04
A	tk 25074-01	tk 25074-02	tk 25074-03	tk 25074-04
Ø = 1,5 mm - 3,5 mm				
x = 36 mm				
V	tk 25065-01	tk 25065-02	tk 25065-03	tk 25065-04
A	tk 25075-01	tk 25075-02	tk 25075-03	tk 25075-04
Ø = 1,5 mm - 3,5 mm				

PRIMUSLINE

Arterienklemmen
Haemostatic forceps

Pinces hémostatiques
Pinzas hemostáticas
Pinze emostatiche

Muß eine PRIMUSLINE Klemme abgebildet sein!

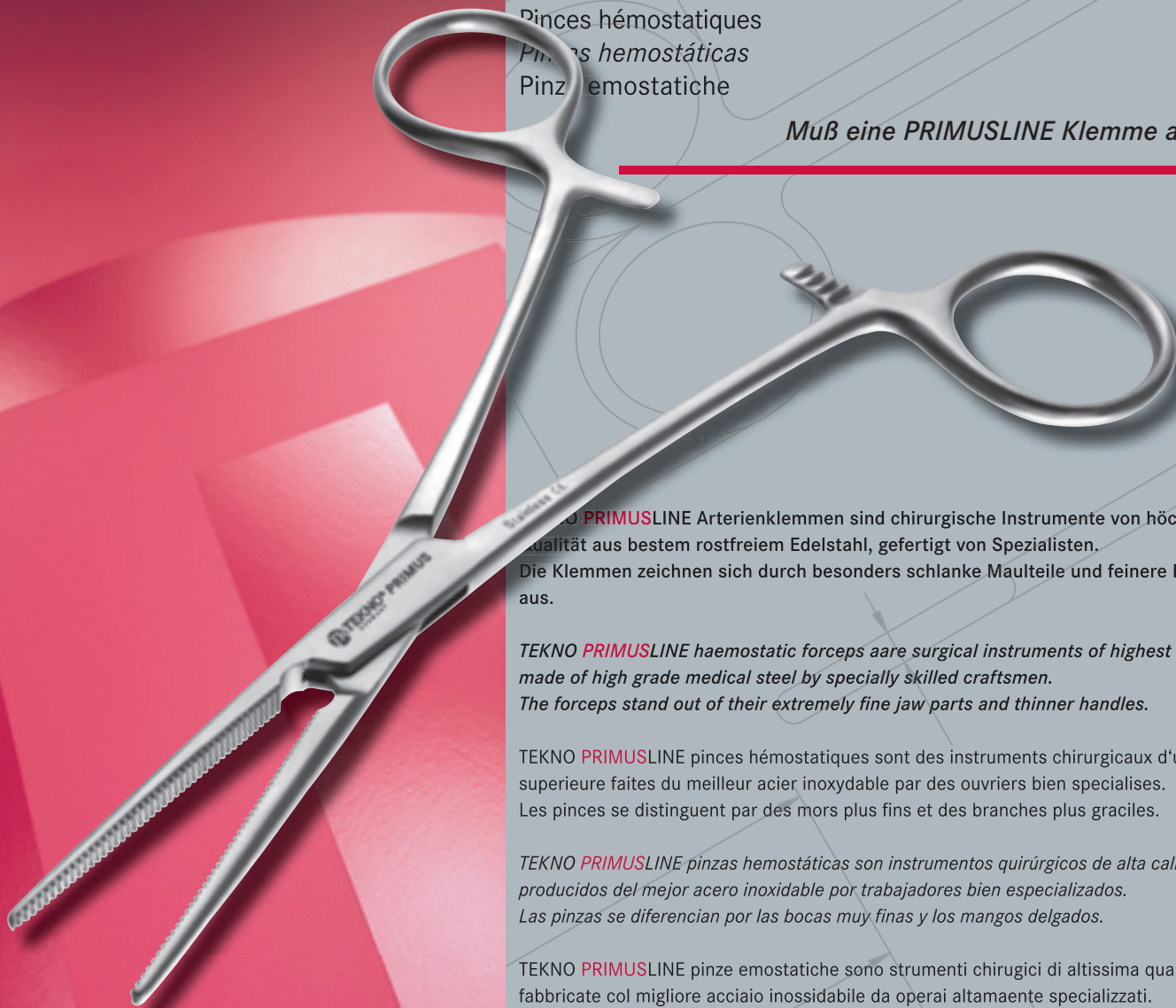

Die **PRIMUSLINE** Arterienklemmen sind chirurgische Instrumente von höchster Qualität aus bestem rostfreiem Edelstahl, gefertigt von Spezialisten. Die Klemmen zeichnen sich durch besonders schlanke Maulteile und feinere Branchen aus.

TEKNO PRIMUSLINE haemostatic forceps are surgical instruments of highest quality, made of high grade medical steel by specially skilled craftsmen. The forceps stand out of their extremely fine jaw parts and thinner handles.

TEKNO **PRIMUSLINE** pinces hémostatiques sont des instruments chirurgicaux d'une qualité supérieure faites du meilleur acier inoxydable par des ouvriers bien spécialisés. Les pinces se distinguent par des mors plus fins et des branches plus graciles.

TEKNO PRIMUSLINE pinzas hemostáticas son instrumentos quirúrgicos de alta calidad, producidos del mejor acero inoxidable por trabajadores bien especializados. Las pinzas se diferencian por las bocas muy finas y los mangos delgados.

TEKNO **PRIMUSLINE** pinze emostatiche sono strumenti chirurgici di altissima qualità, fabbricate col migliore acciaio inossidabile da operai altamente specializzati. Le pinze si differenziano per il morso e le branche fini.

Gewebe- und Darmfazzangen
Tissue and intestinal holding forceps

Pinces intestinales et de tissue
Pinzas para intestinos y tejidos
 Pinze per tessuti ed intestino

PRIMUSLINE



BABCOCK

160 mm - 6¼"	tk 28280-16-P
180 mm - 7"	tk 28280-18-P
200 mm - 8"	tk 28280-20-P



ALLIS

150 mm - 6"	tk 28140-15-P	tk 28160-15-P
190 mm - 7½"		tk 28160-19-P



Zähne 4x5 5x6
 Teeth
 Dents
 Dientes
 Denti

Arterienklemmen
Haemostatic forceps





Pinces hémostatiques
Pinzas hemostáticas
Pinze emostatiche

PRIMUSLINE





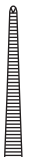

HARTMANN	 1:1	 1:1
	100 mm - 4"	tk 12000-10-P

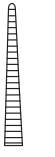

MICRO-MOSQUITO					
	100 mm - 4"	tk 12020-10-P	tk 12021-10-P	tk 12022-10-P	tk 12023-10-P
	120 mm - 4 3/4"	tk 12020-12-P	tk 12021-12-P	tk 12022-12-P	tk 12023-12-P
			1x2	1x2	



HALSTED-MOSQUITO					
	125 mm - 5"	tk 12010-12-P	tk 12011-12-P	tk 12012-12-P	tk 12013-12-P
	140 mm - 5 1/2"	tk 12010-14-P	tk 12011-14-P	tk 12012-14-P	tk 12013-14-P
			1x2	1x2	

Arterienklemmen
Haemostatic forceps

Pinces hémostatiques
Pinzas hemostáticas
Pinze emostatiche

PRIMUSLINE



KELLY

140 mm - 5 1/2"	tk 12040-14-P	tk 12041-14-P
-----------------	----------------------	----------------------

KELLY-RANKIN

160 mm - 6 1/4"	tk 12040-16-P	tk 12041-16-P
-----------------	----------------------	----------------------

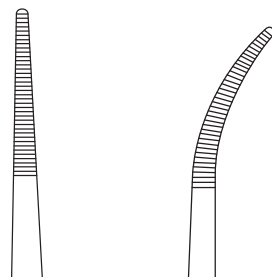

CRILE

140 mm - 5 1/2"	tk 12050-14-P	tk 12051-14-P
-----------------	----------------------	----------------------

CRILE-RANKIN

160 mm - 6 1/4"	tk 12050-16-P	tk 12051-16-P
-----------------	----------------------	----------------------

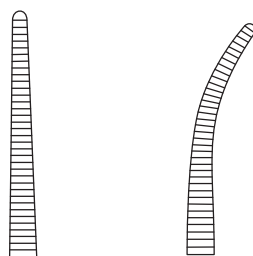

Arterienklemmen
Haemostatic forceps

Pinces hémostatiques
Pinzas hemostáticas
Pinze emostatiche

PRIMUSLINE

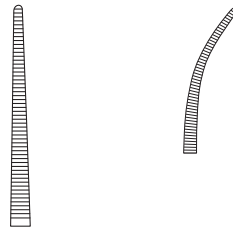

P É A N

130 mm - 5"	tk 12058-13-P	tk 12059-13-P
140 mm - 5½"	tk 12058-14-P	tk 12059-14-P
160 mm - 6¼"	tk 12058-16-P	tk 12059-16-P

graziles Modell
delicate pattern
modèle délicat
modelo delicado
modello delicato

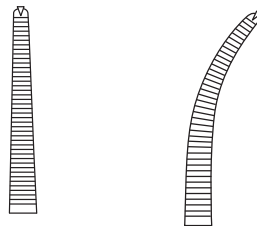

K O C H E R

130 mm - 5"	tk 12078-13-P	tk 12079-13-P
140 mm - 5½"	tk 12078-14-P	tk 12079-14-P
160 mm - 6¼"	tk 12078-16-P	tk 12079-16-P

graziles Modell
delicate pattern
modèle délicat
modelo delicado
modello delicato

1x2

1x2

Arterienklemmen
Haemostatic forceps

Pinces hémostatiques
Pinzas hemostáticas
Pinze emostatiche

PRIMUSLINE



PÉAN- FINO						
	1:1	1:1	1:1	1:1	1:1	1:1
	145 mm - 5 3/4"	165 mm - 6 1/2"	185 mm - 7 1/4"	140 mm - 5 1/2"	160 mm - 6 1/4"	180 mm - 7"
	tk 12062-14-P	tk 12062-16-P	tk 12062-18-P	tk 12063-14-P	tk 12063-16-P	tk 12063-18-P



KOCHER- FINO						
	1:1	1:1	1:1	1:1	1:1	1:1
	145 mm - 5 3/4"	165 mm - 6 1/2"	185 mm - 7 1/4"	145 mm - 5 3/4"	160 mm - 6 1/4"	180 mm - 7"
	tk 12082-14-P	tk 12082-16-P	tk 12082-18-P	tk 12083-14-P	tk 12083-16-P	tk 12083-18-P
	1x2	1x2	1x2	1x2	1x2	1x2

Arterienklemmen
Haemostatic forceps

Pinces hémostatiques
Pinzas hemostáticas
Pinze emostatiche



1:2



1:1

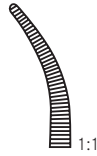

1:1

HARTMANN

100 mm - 4"	tk 12000-10	tk 12001-10
-------------	-------------	-------------



HALSTED-
MOSQUITO



125 mm - 5"	tk 12010-12	tk 12011-12	tk 12012-12	tk 12013-12
140 mm - 5½"	tk 12010-14	tk 12011-14	tk 12012-14	tk 12013-14

1x2

1x2

125 mm - 5"	tk 12110-12	tk 12111-12	tk 12112-12	tk 12113-12
-------------	-------------	-------------	-------------	-------------

Titan
Titanium
Titane
Titanio
Titanio



1x2

1x2



MICRO-
MOSQUITO

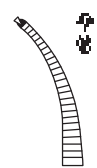
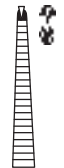

100 mm - 4"	tk 12020-10	tk 12021-10	tk 12022-10	tk 12023-10
120 mm - 4¾"	tk 12020-12	tk 12021-12	tk 12022-12	tk 12023-12

Arterienklemmen
Haemostatic forceps

Pinces hémostatiques
Pinzas hemostáticas
Pinze emostatiche



1:2

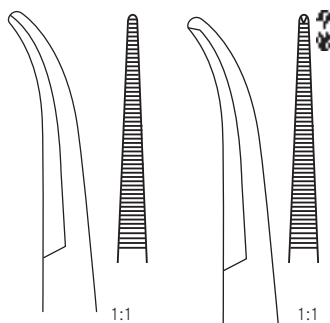

1:1

1:1

DANDY

140 mm - 5 1/2"

tk 12030-14

tk 12032-14

seitlich gebogen
curved to the side
courbe sur le plat
curva al lado
curvata lateralmente



1:2

MOSQUITO-DANDY

tk 12031-12

120 mm - 4 3/4"

seitlich gebogen
curved to the side
courbe sur le plat
curva al lado
curvata lateralmente



1:2

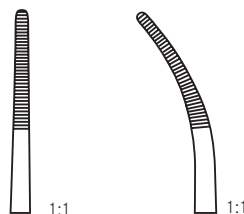

1:1

1:1

PROVIDENCE-HOSPITAL

140 mm - 5 1/2"

tk 12020-14

tk 12021-14

Arterienklemmen
Haemostatic forceps

Pinces hémostatiques
Pinzas hemostáticas
Pinze emostatiche

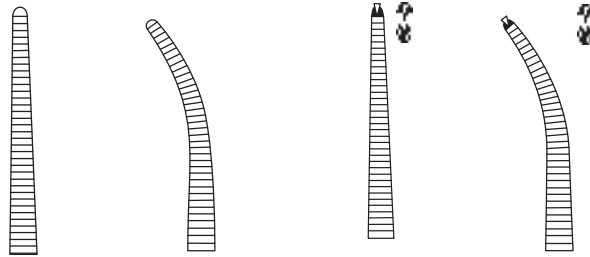

CRILE

140 mm - 5 1/2"	tk 12050-14	tk 12051-14	tk 12052-14	tk 12053-14
-----------------	-------------	-------------	-------------	-------------

CRILE-RANKIN

160 mm - 6 1/4"	tk 12050-16	tk 12051-16	tk 12054-16	tk 12055-16
-----------------	-------------	-------------	-------------	-------------

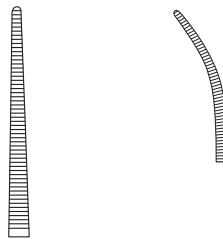

PÉAN

130 mm - 5"	tk 12058-13	tk 12059-13
140 mm - 5 1/2"	tk 12058-14	tk 12059-14
160 mm - 6 1/4"	tk 12058-16	tk 12059-16

graziles Modell
delicate pattern
modèle délicat
modelo delicado
modello delicato

Arterienklemmen
Haemostatic forceps

Pinces hémostatiques
Pinzas hemostáticas
Pinze emostatiche



1:2



1:1

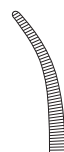

1:1

LERICHE

150 mm - 6"	tk 12034-15	tk 12035-15
-------------	--------------------	--------------------



KELLY

140 mm - 5 1/2"	tk 12040-14	tk 12041-14
-----------------	--------------------	--------------------

KELLY-RANKIN

160 mm - 6 1/4"	tk 12040-16	tk 12041-16
-----------------	--------------------	--------------------

Arterienklemmen
Haemostatic forceps

Pinces hémostatiques
Pinzas hemostáticas
Pinze emostatiche

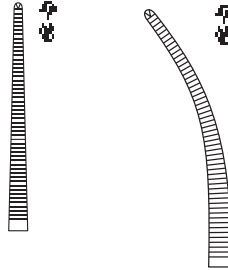

KOCHER

130 mm - 5"	tk 12078-13	tk 12079-13
140 mm - 5½"	tk 12078-14	tk 12079-14
160 mm - 6¼"	tk 12078-16	tk 12079-16

graziles Modell
delicate pattern
modèle délicat
modelo delicado
modello delicato

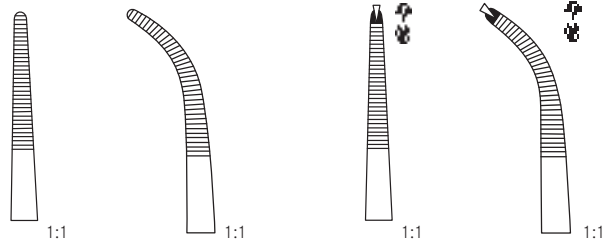

ADSON

185 mm - 7¼"	tk 12210-18	tk 12211-18	tk 12212-18	tk 12213-18
--------------	--------------------	--------------------	--------------------	--------------------

1:2

Arterienklemmen
Haemostatic forceps

Pinces hémostatiques
Pinzas hemostáticas
Pinze emostatiche

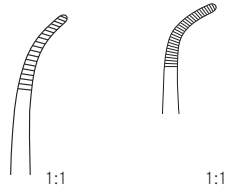

BABY-MIXTER

140 mm - 5 1/2"	tk 12220-14	
180 mm - 7"		tk 12220-18

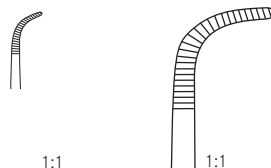

BABY-ADSON

140 mm - 5 1/2"	tk 12221-14	
180 mm - 7"		tk 12221-18

Gewebe- und Darmfazzangen
Tissue and intestinal holding forceps

Pinces intestinales et de tissue
Pinzas para tejidos y intestinos
Pinze per tessuti ed intestinali

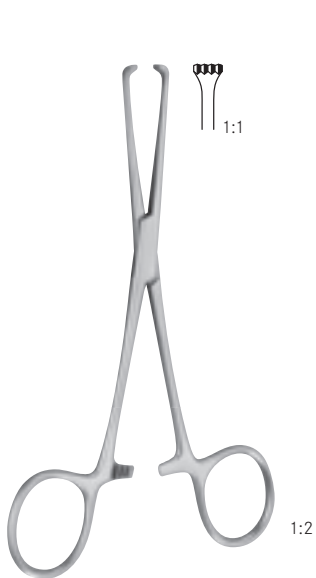

ALLIS-BABY

130 mm - 5"

tk 28100-14

4 x 5



ALLIS

150 mm - 6"

tk 28140-15

tk 28160-15

190 mm - 7½"

tk 28160-19

250 mm - 9¾"

tk 28160-25

4 x 5

5 x 6



ALLIS-ADAIR

155 mm - 6"

tk 28167-15

10 x 11



THOMS-ALLIS

200 mm - 8"

tk 28180-20

6 x 7



LOCKWOOD

200 mm - 8"

tk 28190-20

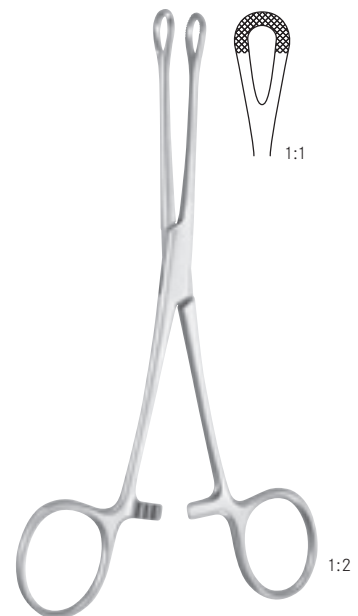

WILLIAMS

160 mm - 6¼"

tk 28192-16

Tupfer- und Schwammzangen
Cotton swab forceps, sponge holding forceps

Pinces à tampons et éponges
Pinzas para tampones y esponjas
Pinze per tamponi

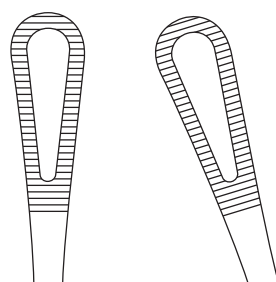

RAMPLEY

180 mm - 7"	tk 15130-18	tk 15131-18
250 mm - 10"	tk 15130-25	tk 15131-25



FOERSTER (BALLENGER)

180 mm - 7"	tk 15180-18	tk 15182-18	tk 15183-18	tk 15185-18
200 mm - 8"		tk 15182-20		tk 15185-20
250 mm - 10"	tk 15180-25	tk 15182-25	tk 15183-25	tk 15185-25

Nasen- und Trachealhäkchen
Trachea and nose retractors

Ecarteurs nasales et trachéales
Separadores para la traquea y la nariz
Uncini tracheali e nasali



1:2

KILNER

150 mm - 6"

tk 48128-15



1:2

GILLIES



1:1

Fig. 1

180 mm - 7"

tk 48130-01



1:1

Fig. 2

tk 48130-02



1:2

LANGE

220 mm - 8³/₄"

tk 16901-22



1:2

COTTLE

160 mm - 6¹/₄"

tk 16902-16



1:2

FOMON

170 mm - 6³/₄"

tk 16904-17

Nasen- und Trachealhäkchen
Trachea and nose retractors

Ecarteurs nasales et trachéales
Separadores para la traquea y la nariz
Uncini tracheali e nasali

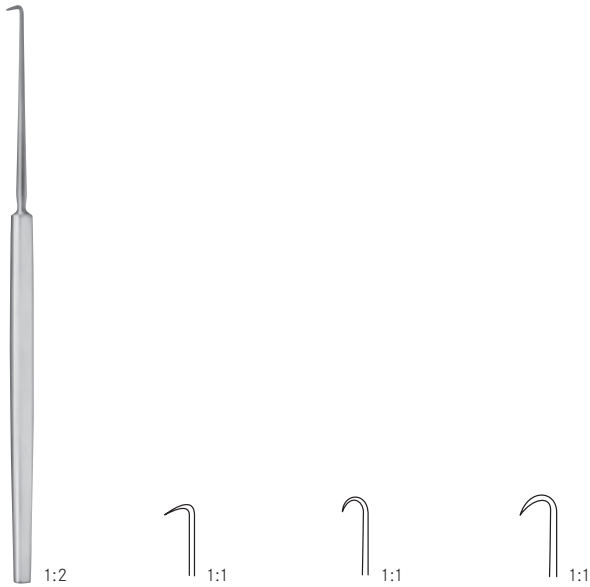

COTTLE

150 mm - 6"	tk 16905-01	tk 16905-02	tk 16905-03
-------------	--------------------	--------------------	--------------------



JOSEPH

150 mm - 6"	tk 16900-15
-------------	--------------------

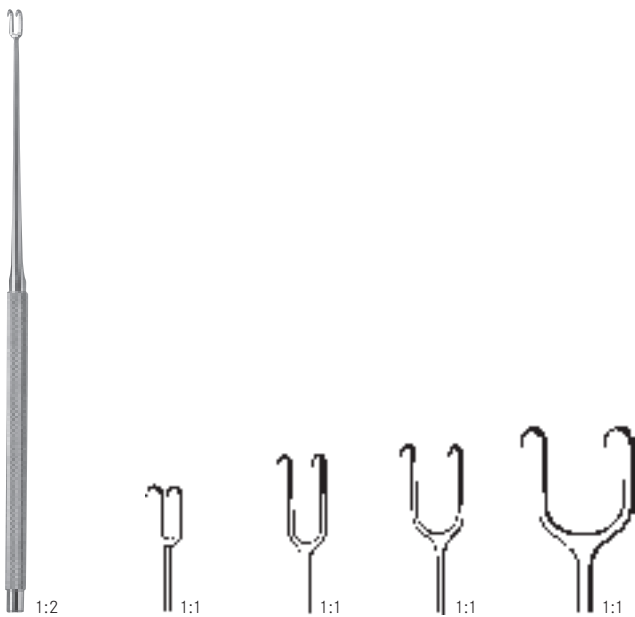

JOSEPH

	2 mm	5 mm	7 mm	10 mm
160 mm - 6 1/4"	tk 16910-02	tk 16910-05	tk 16910-07	tk 16910-10

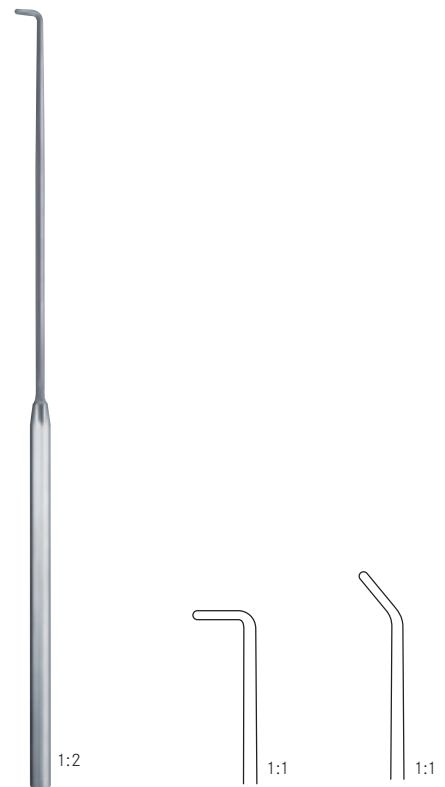

CRILE

	Fig. 1	Fig. 2
200 mm - 8"	tk 25308-01	tk 25308-02

Nasen- und Trachealhäkchen
Trachea and nose retractors

Ecarteurs nasales et trachéales
Separadores para la traquea y la nariz
Uncini tracheali e nasali

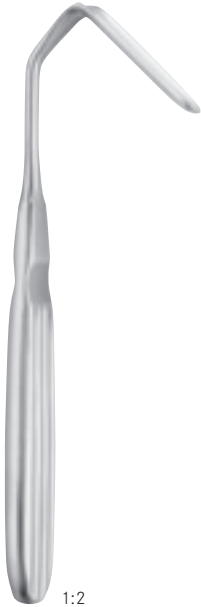

1:2
AUFRICHT
190 mm - 7½"

tk 16906-19



1:2
AUFRICHT
190 mm - 7½"

tk 16906-59



1:2
AUFRICHT
tk 17919-13

Nasenhaken
Nasal hook
Crochet pour le nez
Gancho para la nariz
Uncino nasale



1:2
CONVERSE
120 mm - 4¾"

tk 16908-12

Nasen- und Trachealhäkchen
Trachea and nose retractors

Ecarteurs nasales et trachéales
Separadores para la traquea y la nariz
 Uncini tracheali e nasali



1:2

KILNER

100 mm - 4"

tk 16907-10



1:2

MARTINEZ KILNER

110 mm - 4¼"

tk 16907-12



1:2

COTTLE

tk 17750-00

Daumenhaken
Thumb hook

Crochet pour le doigt
Gancho para el dedo

Uncino da fissare sul pollice

Nasen- und Trachealhäkchen
Trachea and nose retractors

Ecarteurs nasales et trachéales
Separadores para la traquea y la nariz
Uncini tracheali e nasali



**COTTLE-
NEIVERT**

200 mm - 8"

tk 16912-20

1:2



1:2

FOMON

160 mm - 6 1/4"

tk 16914-16



1:2

COTTLE

150 mm - 6"



1:1

tk 16915-01



1:1

tk 16915-02



1:1

tk 16915-03



1:2

NEIVERT

160 mm - 6 1/4"

tk 16916-16



1:2

COTTLE

150 mm - 6"

tk 16917-15



1:2

tk 16918-15



1:2

ITERSON

160 mm - 6 1/4"



1:1

tk 16920-16



1:1

tk 16922-16

Trachealhäkchen
Trachea retractors

Ecarteurs nasales et trachéales
Separadores para la traquea
Uncini tracheali



1:2

JACKSON

150 mm - 6"

tk 16930-15



1:2

LUKENS

170 mm - 6²/₃"

tk 16933-17



1:2

JACKSON

170 mm - 6²/₃"

tk 16935-17



1:2



1:1



1:1



1:1

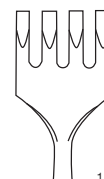

1:1

160 mm - 6¹/₄"

tk 17001-16

tk 17002-16

tk 17003-16

tk 17004-16

scharf
sharp

pointu
agudo
acuto



1:1



1:1



1:1

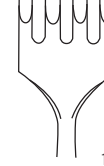

1:1

160 mm - 6¹/₄"

tk 17011-16

tk 17012-16

tk 17013-16

tk 17014-16

stumpf
blunt

mousse
romo
smusso

Trachealhäkchen
Trachea retractors

Ecarteurs trachéales
Separadores para la traquea
Uncini tracheali



1:2



1:1



1:1

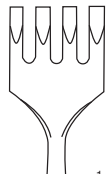

1:1

160 mm - 6 1/4"	tk 17021-16	tk 17022-16	tk 17024-16
-----------------	--------------------	--------------------	--------------------

flexibel, scharf
flexible, sharp

flexible, pointu
flexible, agudo
flessibile, acuto



1:1

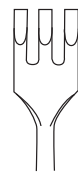

1:1



1:1

160 mm - 6 1/4"	tk 17031-16	tk 17032-16	tk 17034-16
-----------------	--------------------	--------------------	--------------------

flexibel, stumpf
flexible, blunt

flexible, mousse
flexible, romo
flessibile, smusso



1:2



1:1

**KNAPP
(ROLLET)**

160 mm - 6 1/4"
tk 17025-16

flexibel, scharf
flexible, sharp
flexible, pointu
flexible, agudo
flessibile, acuto



1:1



1:1



1:1



1:1

DESMARRES

	x = 8 mm	x = 10 mm	x = 12 mm
160 mm - 6 1/4"	tk 17038-08	tk 17038-10	tk 17038-12

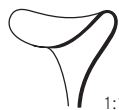

1:1

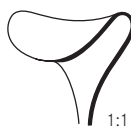

1:1

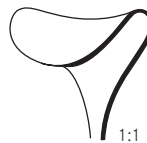

1:1

	x = 14 mm	x = 16 mm	x = 18 mm
160 mm - 6 1/4"	tk 17038-14	tk 17038-16	tk 17038-18

1:2

Brust Dissektoren
Mamaplasty retractors

Ecarteurs mammaires
Separadores mamarias
Divaricatori per seno

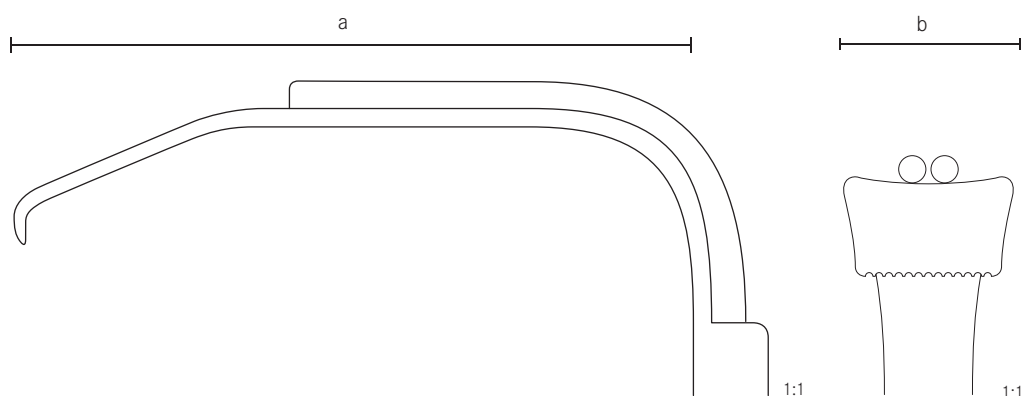

a	b	185 mm - 7/4"	185 mm - 7/4"
90 mm	24 mm	tk 17217-01	tk 17217-06
115 mm	24 mm	tk 17217-02	tk 17217-07
150 mm	25 mm	tk 17217-05	tk 17217-08
150 mm	36 mm	tk 17217-03	tk 17217-09
190 mm	30 mm	tk 17217-04	tk 17217-10

gezahnt und Kaltlichtbeleuchtung
toothed with fiber optic illumination

dentelée avec illumination à lumière froide
dentada con iluminación de luz fría
dentata con illuminazione a luce fredda

mit Spülrohr
with irrigation tube

avec tube de lavage
con tubo lavador
con tubo di lavaggio

ohne Spülrohr
without irrigation tube

sans tube de lavage
sin tubo lavador
senza tubo di lavaggio

a	b	185 mm - 7/4"	185 mm - 7/4"
90 mm	24 mm	tk 17217-21	tk 17217-26
115 mm	24 mm	tk 17217-22	tk 17217-27
150 mm	25 mm	tk 17217-25	tk 17217-28
150 mm	36 mm	tk 17217-23	tk 17217-29
190 mm	30 mm	tk 17217-24	tk 17217-30

ohne Zähne mit Kaltlichtbeleuchtung
non-toothed with fiber optic illumination

sans denture avec illumination à lumière froide
sin dentada con iluminación de luz fría
no dentata con illuminazione a luce fredda

mit Spülrohr
with irrigation tube

avec tube de lavage
con tubo lavador
con tubo di lavaggio

ohne Spülrohr
without irrigation tube

sans tube de lavage
sin tubo lavador
senza tubo di lavaggio

Brust Dissektoren
Mamaplasty retractors

Ecarteurs mammaires
Separadores mamarias
Divaricatori per seno



1:2

FERREIRA

a	b	185 mm - 7/4"	
90 mm	24 mm	tk 17219-01	tk 17219-06
115 mm	24 mm	tk 17219-02	tk 17219-07
150 mm	25 mm	tk 17219-03	tk 17219-08
150 mm	36 mm	tk 17219-04	tk 17219-09
190 mm	30 mm	tk 17219-05	tk 17219-10

**MACCOLLUM -
DINGMAN**

315 mm - 12½"

tk 16903-30

Wundhaken
Retractors

Ecarteurs
Retradores
Divaricatori

ohne Zahnung
non-toothed

sans denture
sin dentada
no dentata

Gezahnt
toothed

denture
dentada
dentata

Brust Dissektoren
Mamaplasty retractors

Ecarteurs mammaires
Separadores mamarias
Divaricatori per seno



330 mm - 13 "	tk 17156-08	tk 17156-10	tk 17156-12
420 mm - 16½ "	tk 17156-09	tk 17156-11	tk 17156-13
abgewinkelt <i>angled</i>	starr <i>rigid</i>	biegsam <i>malleable</i>	Schaft isoliert <i>Shaft insulated</i>
angulé <i>angulado</i>	rigide <i>rigido</i>	maléable <i>maleable</i>	Tige isolée <i>Tija aislada</i>
angolato	rigido	flessibile	Asta isolata



330 mm - 13 "	tk 17156-01	tk 17156-03	tk 17156-05
420 mm - 16½ "	tk 17156-02	tk 17156-04	tk 17156-06
	starr <i>rigid</i>	biegsam <i>malleable</i>	Schaft isoliert <i>Shaft insulated</i>
	rigide <i>rigido</i>	maléable <i>maleable</i>	Tige isolée <i>Tija aislada</i>
	rigido	flessibile	Asta isolata



	x = 25 mm	x = 33 mm
315 mm - 12½ "	tk 17156-20	tk 17156-21

halbstarr
semi rigid
semi rigide
semi rigido
semi rigido

Wundhaken
Retractors

Ecarteurs
Separadores
Divaricatori



1:2

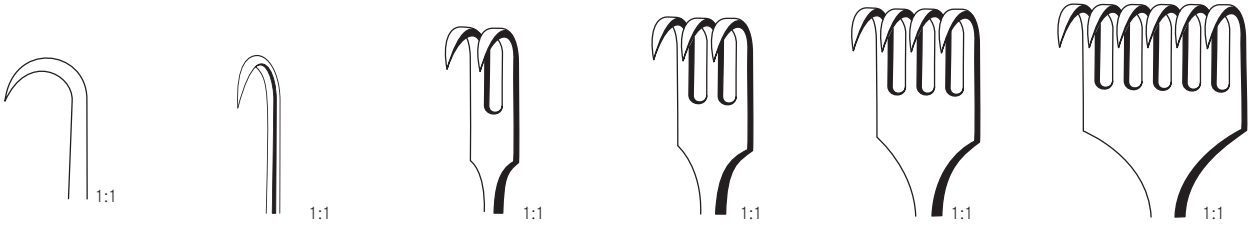

VOLKMANN

215 mm - 8½"	tk 17061-21	tk 17062-21	tk 17063-21	tk 17064-21	tk 17066-21
--------------	--------------------	--------------------	--------------------	--------------------	--------------------

scharf
sharp

pointu
agudo
acuto

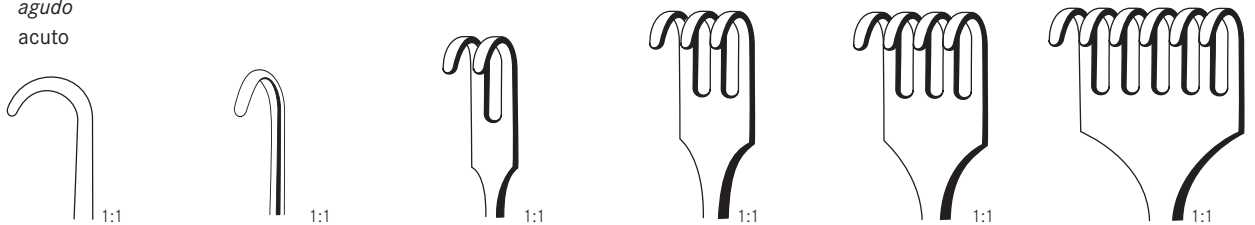

215 mm - 8½"	tk 17071-21	tk 17072-21	tk 17073-21	tk 17074-21	tk 17076-21
--------------	--------------------	--------------------	--------------------	--------------------	--------------------

stumpf
blunt

mousse
romo
smusso



1:2

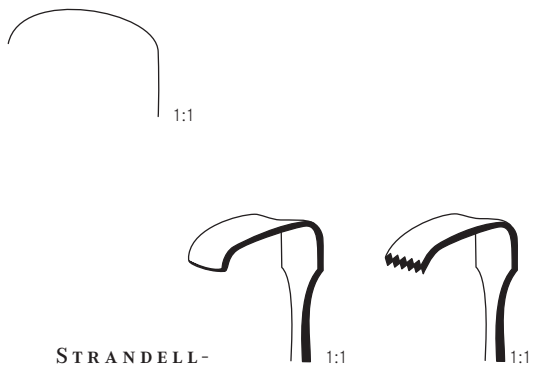

STRANDELL-STILLE

	Fig. 1	Fig. 2
190 mm - 7½"	tk 17079-01	tk 17079-02

gezahnt
saw edge
dentelé
dentado
dentato



1:2

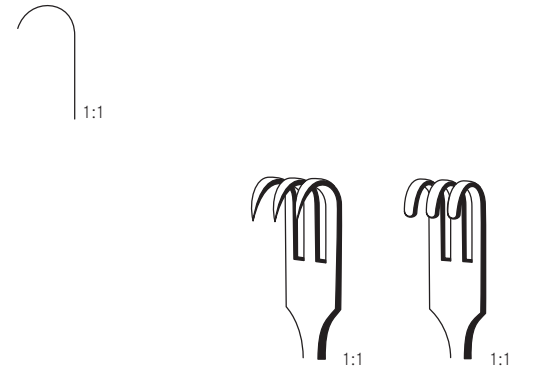

SENN-MUELLER

160 mm - 6¼"	tk 17080-16	tk 17081-16
--------------	--------------------	--------------------

scharf
sharp
pointu
agudo
acuto

stumpf
blunt
mousse
romo
smusso

Wundhaken - Wundspreizer
Retractors - Wound spreaders, self-retaining

Ecarteurs - Ecarteurs autostatiques
Separadores - Separadores autoestáticos
Divaricatori - Divaricatori autostatici



1:2



1:1



1:1

MEYERDING

	18 mm x 7 mm	10 mm x 3 mm
180 mm - 7"	tk 17090-18	tk 17091-18



1:1



1:1

	16 mm x 5 mm	7 mm x 4 mm
180 mm - 7"	tk 17092-18	tk 17093-18



1:1



1:1

	10 mm x 4 mm	7 mm x 4 mm
180 mm - 7"	tk 17094-18	tk 17095-18

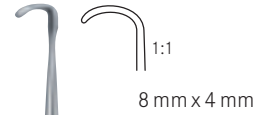

1:1

8 mm x 4 mm

RAGNELL-DAVIS

140 mm - 5½"

tk 17084-14

15 mm x 5,5 mm

1:2

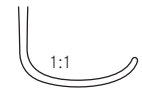

1:1



1:2

ALM

	4 x 4	4 x 4	4 x 4
70 mm - 2¾"	tk 17330-07	tk 17330-17	tk 17331-07
100 mm - 4"	tk 17330-10	tk 17330-20	tk 17331-10

scharf

sharp

pointu

agudo

acuto

halbscharf

semi sharp

semi pointu

semi agudo

semi acuto

stumpf

blunt

mousse

romo

smusso



1:2

HOLTZHEIMER

	4 x 4	4 x 4
100 mm - 4"	tk 17336-10	tk 17337-10

scharf

sharp

pointu

agudo

acuto

stumpf

blunt

mousse

romo

smusso

Wundhaken
Retractors

Ecarteurs
Separadores
Divaricatori



1:1

FREEMAN

	x = 22 mm
100 mm - 4"	tk 17147-09

scharf
sharp
pointu
agudo
acuto



1:1

FREEMAN

	x = 38 mm
100 mm - 4"	tk 17147-10

scharf
sharp
pointu
agudo
acuto



1:1

GORNEY

	x = 38 mm
75 mm - 3"	tk 17148-38

scharf
sharp
pointu
agudo
acuto

Wundhaken | Ecarteurs
 Retractors | Separadores
 Divaricatori



FREEMAN

	x = 22 mm	x = 38 mm
180 mm - 7"	tk 17147-22	tk 17147-38

scharf
 sharp
 pointu
 agudo
 acuto

Wundhaken
Retractors

Ecarteurs
Separadores
Divaricatori



YANCOSKIE

	x = 150 mm
180 mm - 7"	tk 17144-15

scharf
sharp
pointu
agudo
acuto



CORONAL LIFT

	x = 70 mm
180 mm - 7"	tk 17145-18

scharf
sharp
pointu
agudo
acuto

Wundhaken | Ecarteurs
 Retractors | Separadores
 Divaricatori



FREEMAN

	x = 12 mm	x = 25 mm
205 mm - 8"	tk 17218-01	tk 17218-02

stumpf
 blunt
 mousse
 romo
 smusso

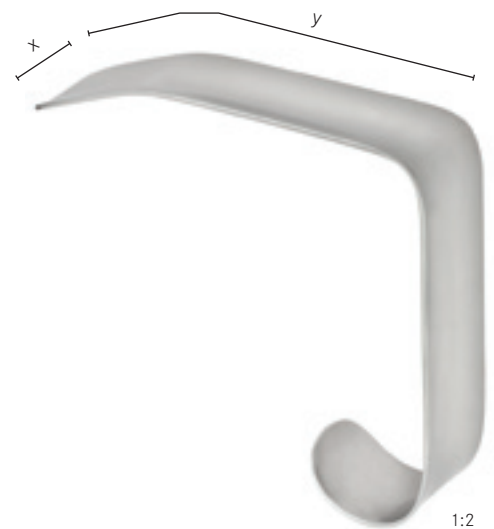

FERREIRA

	x = 23 mm / y = 120 mm
100 mm - 4"	tk 17218-03

stumpf
 blunt
 mousse
 romo
 smusso

Weichteilhaken für die Kieferchirurgie
Soft tissue retractors for maxillo-facial surgery

Ecarteurs pour la chirurgie maxillo-faciale
Ganchos para cirugía maxilofacial
Uncini per chirurgia massilofaciale

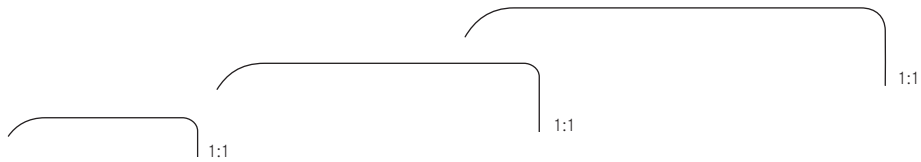

OBWEGESER

	7 mm x 25 mm	10 mm x 42 mm	12 mm x 55 mm
215 mm - 8½"	tk 17114-01	tk 17114-05	tk 17114-06

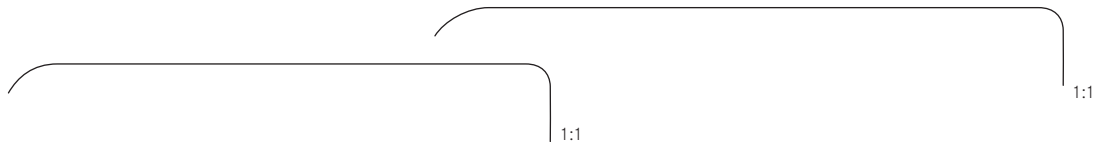

	14 mm x 70 mm	16 mm x 80 mm
215 mm - 8½"	tk 17114-07	tk 17114-09



7

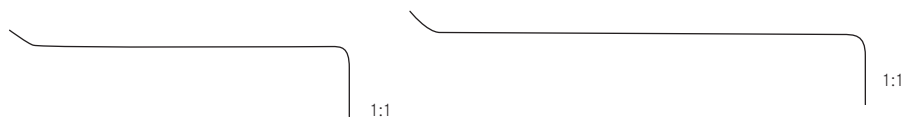

OBWEGESER

	13 mm x 42 mm	12 mm x 60 mm
220 mm - 8¾"	tk 52715-01	tk 52715-02



	16 mm x 80 mm
220 mm - 8¾"	tk 52715-03

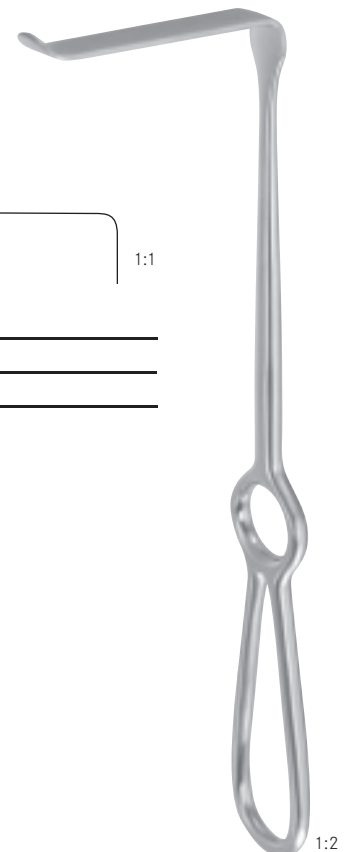

Weichteilhaken für die Kieferchirurgie
Soft tissue retractors for maxillo-facial surgery

Ecarteurs pour la chirurgie maxillo-faciale
Ganchos para cirugía maxilofacial
 Uncini per chirurgia massilofaciale



1:2

OBWEGESER

	44 mm x 9,5 mm	70 mm x 11,5 mm
220 mm - 8 ³ / ₄ "	tk 52717-22	tk 52719-22



1:2

OBWEGESER

155 mm - 6"	tk 52723-16
-------------	--------------------



1:2

OBWEGESER

	8 mm	10 mm
160 mm - 6 ¹ / ₄ "	tk 52725-08	tk 52725-10

biegsam
malleable
 malléable
 flexible
 flessibile

Wundhaken - Wundsperrer
Retractors - Wound spreaders, self-retaining

Ecarteurs - Ecarteurs autostatiques
Separadores - Separadores autoestáticos
 Divaricatori - Divaricatori autostatici



1:2

WEITLANER-LOKTITE

105 mm - 4 $\frac{1}{4}$ "	tk 17400-10	tk 17400-20	tk 17401-10
scharf	halbscharf	stumpf	
<i>sharp</i>	<i>semi sharp</i>	<i>blunt</i>	
pointu	semi pointu	mousse	
<i>agudo</i>	<i>semi agudo</i>	<i>romo</i>	
acuto	semi acuto	smusso	



WEITLANER-LOKTITE

130 mm - 5"	tk 17402-13	tk 17402-23	tk 17403-13
165 mm - 6 $\frac{1}{2}$ "	tk 17402-16	tk 17402-26	tk 17403-16
200 mm - 8"	tk 17404-20	tk 17404-30	tk 17405-20
260 mm - 10 $\frac{1}{4}$ "	tk 17404-26	tk 17404-36	tk 17405-26
scharf	halbscharf	stumpf	
<i>sharp</i>	<i>semi sharp</i>	<i>blunt</i>	
pointu	semi pointu	mousse	
<i>agudo</i>	<i>semi agudo</i>	<i>romo</i>	
acuto	semi acuto	smusso	

Wundhaken - Wundsperrer
Retractors - Wound spreaders, self-retaining

Ecarteurs - Ecarteurs autostatiques
 Separadores - Separadores autoestáticos
 Divaricatori - Divaricatori autostatici



1:2

WULLSTEIN

100 mm - 4"	tk 17408-01	tk 17408-02
-------------	--------------------	--------------------



BELUCCI

110 mm - 4 1/4"	tk 17410-11	tk 17411-11
130 mm - 5"	tk 17410-13	tk 17411-13

links, stumpf
 left, blunt
 gauche, mousse
 izquierda, romo
 sinistra, smusso

rechts, stumpf
 right, blunt
 droit, mousse
 derecha, romo
 destra, smusso



1:2

MILIGAN

130 mm - 5"	tk 17409-13
-------------	--------------------

stumpf
 blunt
 mousse
 romo
 smusso



1:2

TRAVERS

205 mm - 8 1/2"	tk 17412-20
-----------------	--------------------

stumpf
 blunt
 mousse
 romo
 smusso

Nadelhalter mit Hartmetalleinsätzen im Maulbereich Needle holders with tungsten-carbide inserts in the jaws

Porte-aiguilles avec des inserts de carbure de tungstène dans les mors
Porte-agujas con insertos de carburo tungsteno en las bocas
Port'aghi con inserti in carburo di tungsteno



Alle Nadelhalter mit „tucar“ Hartmetalleinsätzen bieten einen sicheren, festen Halt der Nadel und verhindern deren Verdrehen. Zur Kennzeichnung sind alle Hartmetall-Nadelhalter an den Ringgriffen bzw. den Branchen vergoldet.

All the needle holders with “tucar” tungsten-carbide inserts offer a safe and secure grip of the needle and prevent the twisting of the same. Needle holders with tungsten-carbide inserts are identified by gold-plated rings or handles.

Tous les porte-aiguilles avec des inserts «tucar» de carbure de tungstène garantissent que les aiguilles sont tenues sûres et fortes et qu'elles ne peuvent pas se tordre. Les portes aiguilles avec des inserts de tungstène de carbure peuvent être reconnus à leurs bagues ou manches dorées.

Todas las porta-agujas “tucar” con los insertos de carburo tungsteno aseguran la sujeción firme y seguro de las agujas que evita la torsión de las cuales. Porta-agujas con insertos de carburo de tungsteno se reconocen por los anillos o mangos dorados.

Tutti i port'aghi con inserti in carburo di tungsteno “tucar” (tungsten-carbide) assicurano una presa dell'ago sicura e forte, che previene la torsione dall'ago stesso. I port'aghi con inserto in carburo di tungsteno sono riconoscibili per la doratura del manico o degli anelli.

0.5 mm

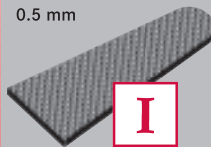

I

Normal für Nadeln und Nahtmaterial bis Stärke 4-0
Regular for use with needles and sutures up to size 4-0

Normale pour aiguilles et matériel à suture jusqu'à l'épaisseur de 4-0
Normal para agujas y material de suturar hasta el espesor de 4-0
Normale per aghi e materiale per sutura fino ad uno spessore di 4-0

0.4 mm

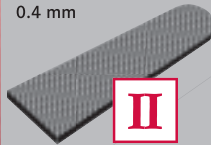

II

Fein für feine Nadeln und Nahtmaterial Stärke 5-0 + 6-0
Fine for delicate needles and sutures sizes 5-0 + 6-0

Fino pour aiguilles fines et matériel à suture à l'épaisseur 5-0 + 6-0
Fine para agujas finas y material de suturar espesores 5-0 + 6-0
Fine per aghi fini e materiale per sutura con spessore 5-0 + 6-0

0.3 mm

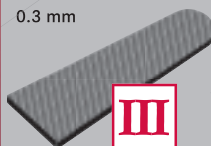

III

Extrafein für Mikro-Nadeln und Nahtmaterial Stärke 7-0 bis 10-0
Extrafine for use with micro-needles and sutures size 7-0 and 10-0

Extrafino pour micro-aiguilles et matériel à suture à l'épaisseur 7-0 à 10-0
Extrafine para micro-agujas y material de suturas espesor 7-0 y 10-0
Extrafine per micro-aghi e materiale per sutura 7-0 e 10-0

Glatt für feine Nadeln und Nahtmaterial Stärke 7-0 bis 12-0
Smooth for delicate needles and sutures sizes 7-0 and 12-0

Liso pour aiguilles fines et matériel à suture à l'épaisseur 7-0 à 12-0
Lisse para agujas finas y material de suturas espesor 7-0 y 12-0
Liscia per aghi fini e materiale per sutura 7-0 e 12-0

IV

Nadelhalter | Porte-aiguilles
Needle holders | Porta-agujas
 Porta aghi

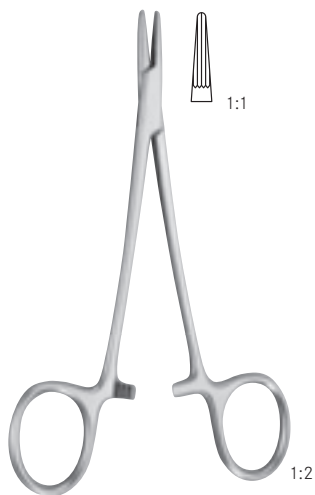

DERF
 125 mm - 5"
tk 20308-12

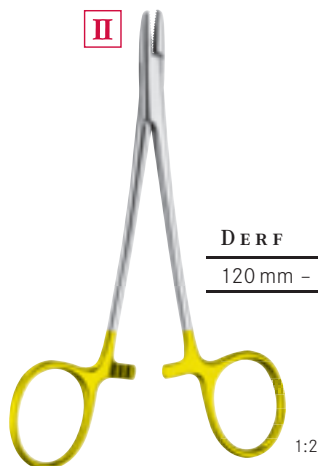

DERF
 120 mm - 4 3/4" | **tk 20008-12** | **tk 20508-12 TC**

ein Maul gefenstert
one fenestrated jaw
 une coté du mors fenêtré
un lado de la boca fenestrada
 una parte del morso finestrado



CRILE-MURRAY
 150 mm - 6"
tk 20001-15



CRILE-WOOD
 150 mm - 6" | **tk 20002-15** | **tk 20502-15 TC**
 180 mm - 7" | **tk 20002-18** | **tk 20502-18 TC**
 200 mm - 8" | **tk 20002-20** | **tk 20502-20 TC**

Nadelhalter
Needle holders

Porte-aiguilles
Porta-agujas
Porta aghi



HEGAR-BAUMGARTNER

140 mm - 5 3/4"	tk 20003-14
140 mm - 5 3/4"	tk 20503-14 TC



BABY-CRILE-WOOD

150 mm - 6"	tk 20504-15 TC
-------------	-----------------------

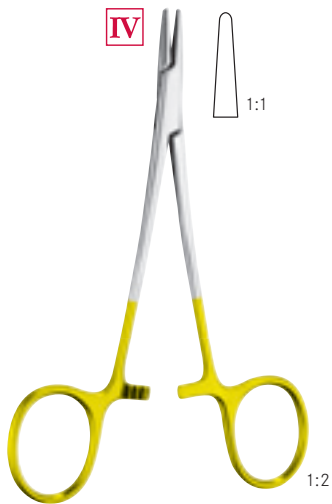

WEBSTER

130 mm - 5"	tk 20009-13
130 mm - 5"	tk 20509-13 TC

glatt
smooth
lisse
liso
liscio



MATHIEU-OLSEN

140 mm - 5 1/2"	tk 20106-14	tk 20516-14 TC
170 mm - 6 3/4"	tk 20106-17	tk 20516-17 TC
200 mm - 8"	tk 20106-20	tk 20516-20 TC

Nadelhalter | Porte-aiguilles
Needle holders | Porta-agujas
 Porta aghi

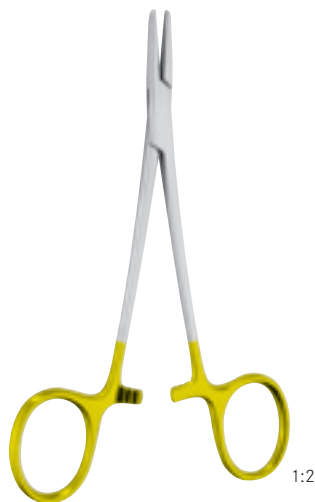

IV



1:1

II



1:1

HALSEY

130 mm - 5"	tk 20010-13	tk 20011-13
130 mm - 5"	tk 20510-13 TC	tk 20511-13 TC

glatt
smooth

lisse
liso
liscio

gerieft
serrated

strié
estriada
zigrinato

II



1:2



1:2

OLSEN-HEGAR

120 mm - 4 ³ / ₄ "	tk 20036-12	tk 20536-12 TC
140 mm - 5 ¹ / ₂ "	tk 20036-14	tk 20536-14 TC
170 mm - 6 ³ / ₄ "	tk 20036-17	tk 20536-17 TC
190 mm - 7 ¹ / ₂ "	tk 20036-19	tk 20536-19 TC

Nadelhalter
Needle holders

Porte-aiguilles
Porta-agujas
Porta aghi

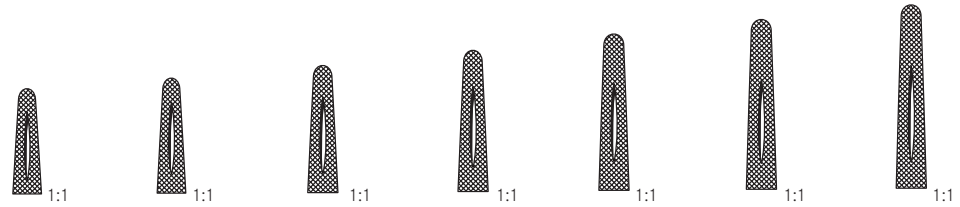

MAYO-HEGAR

140mm - 5½"	160mm - 6¼"	180mm - 7"	200mm - 8"	240mm - 9½"	260mm - 10¼"	300mm - 12"
tk 20012-14	tk 20012-16	tk 20012-18	tk 20012-20	tk 20012-24	tk 20012-26	tk 20012-30

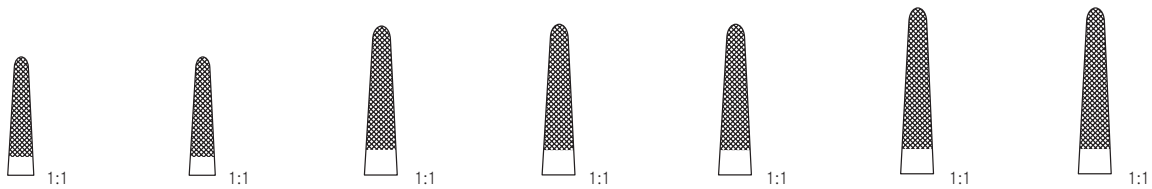

MAYO-HEGAR

140mm - 5½"	160mm - 6¼"	180mm - 7"	200mm - 8"	240mm - 9½"	260mm - 10¼"	300mm - 12"
tk 20512-14 TC	tk 20512-16 TC	tk 20512-18 TC	tk 20512-20 TC	tk 20512-24 TC	tk 20512-26 TC	tk 20512-30 TC

Nadelhalter | Porte-aiguilles
Needle holders | Porta-agujas
 Porta aghi

II



GILLIES

160 mm - 6 1/4"	tk 20035-16	tk 20535-16 TC
-----------------	--------------------	-----------------------



1:1



1:1



GILLIES

145 mm - 5 3/4"	tk 20035-14	tk 20535-14 TC
-----------------	--------------------	-----------------------



1:1



1:1



FOSTER-GILLIES

120 mm - 4 3/4"	tk 20546-12 TC	tk 20548-12 TC	tk 20547-12 TC	tk 20549-12 TC
-----------------	-----------------------	-----------------------	-----------------------	-----------------------



gerade, gerieft
straight, serrated
 droit, strié
recta, estriada
 retto, zigrinato

gerade, glatt
straight, smooth
 droit, lisse
recta, lisa
 retto, liscio

gebogen, gerieft
curved, serrated
 courbe, strié
curva, estriada
 curvo, zigrinato

gebogen, glatt
curved, smooth
 courbe, lisse
curva, lisa
 curvo, liscio

Nadelhalter
Needle holders

Porte-aiguilles
Porta-agujas
Porta aghi

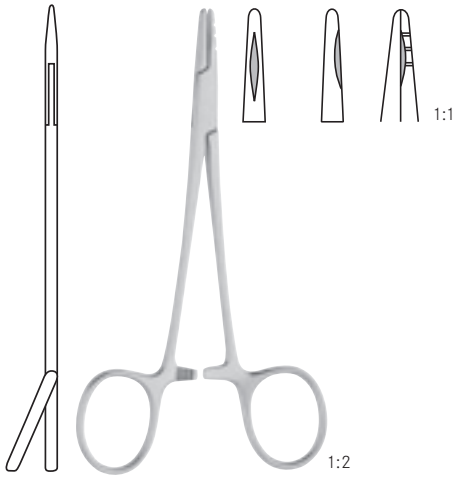

NEIVERT

125 mm - 5"

tk 20304-13

II

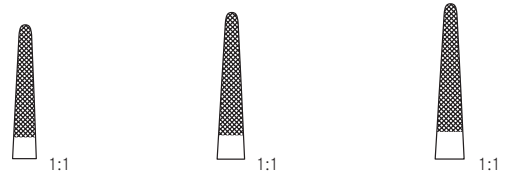
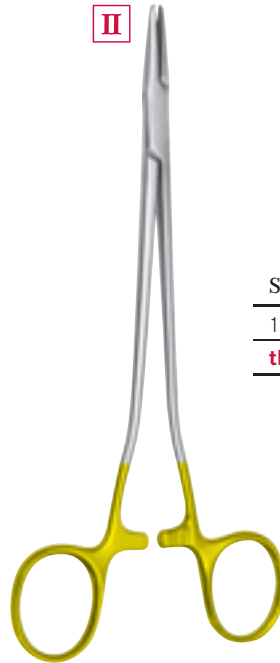

SAROT

180 mm - 7"	200 mm - 8"	260 mm - 10 1/4"
tk 20524-18 TC	tk 20524-20 TC	tk 20524-26 TC

I

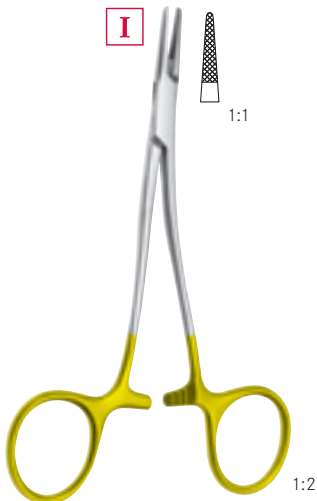

KILNER

135 mm - 5 1/4"

tk 20533-13 TC

I

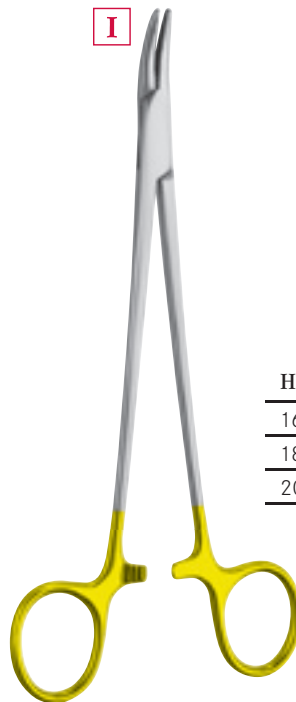

HEANEY

160 mm - 6 1/4"	tk 20515-16 TC
180 mm - 7"	tk 20515-18 TC
200 mm - 8"	tk 20515-20 TC

Nadelhalter | Porte-aiguilles
Needle holders | Porta-agujas
 Porta aghi

II



DE BAKEY

180 mm - 7"	200 mm - 8"	230 mm - 9"	260 mm - 10¼"
tk 20522-18 TC	tk 20522-20 TC	tk 20522-23 TC	tk 20522-26 TC

III

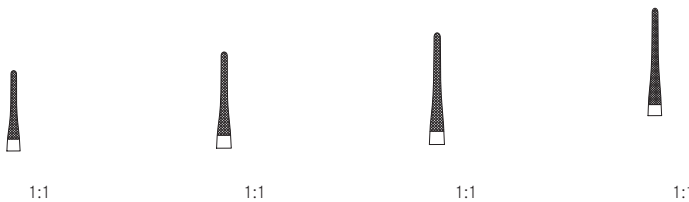

VASCULAR

140 mm - 5½"	180 mm - 7"	200 mm - 8"	230 mm - 9"
tk 20525-14 TC	tk 20525-18 TC	tk 20525-20 TC	tk 20525-23 TC

Nadelhalter
Needle holders

Porte-aiguilles
Porta-agujas
Porta aghi

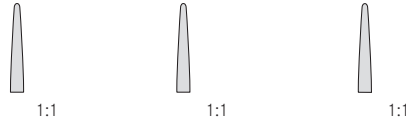

130 mm - 5"	150 mm - 5¾"	170 mm - 6¾"
tk 20570-13	tk 20570-15	tk 20570-17

mit Spezialbeschichtung im Maul
with special coated jaw

mors avec couche special
boca con capa especial
morso "diamant dust"

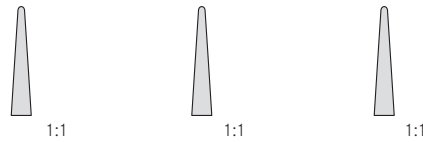

180 mm - 7"	200 mm - 8"	230 mm - 9"
tk 20570-18	tk 20570-20	tk 20570-23

mit Spezialbeschichtung im Maul
with special coated jaw

mors avec couche special
boca con capa especial
morso "diamant dust"



Beschichtung mit Hartmetallstaub.
Sicheres Halten der Nadel
Speziell geeignet für feine Nadelhalter, keine Bruchgefahr der Maulspitzen.

*Jaws coated with carbide dust.
Secure fixing of the needle.
Suitable for delicate needle-holders, no risk of breakage of the jaws*

Mors recouverts de poussière de carbure.
Tenu sûre de l'aiguille.
Spécialement approprié pour des port-aiguilles fins, pas de risque des ruptures des mors.

*Bocas revestidas con polvo de carburo.
Fija seguramente la aguja.
Apto para porta-agujas delicados, ningún riesgo de roturas de las bocas.*

Morsi rivestiti con polvere di carburo.
Regge sicuramente l'ago.
Appropriato particolarmente per porta-aghi sottili, senza rischio per rottura di morso.

Nadelhalter | Porte-aiguilles
Needle holders | Porta-agujas
 Porta aghi



II

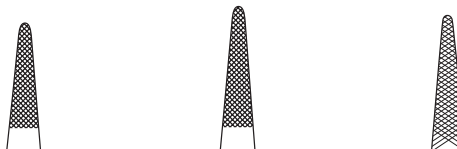

LICHTENBERG

170 mm - 6 3/4"	tk 20615-17 TC		tk 20115-17
200 mm - 8"		tk 20615-20 TC	tk 20115-20

III



DIETRICH

160 mm - 6 1/4"	tk 20560-16 TC
180 mm - 7"	tk 20560-18 TC
200 mm - 8"	tk 20560-20 TC
230 mm - 9"	tk 20560-23 TC
250 mm - 9 3/4"	tk 20560-25 TC

II



III



RYDER

130 mm - 5"	tk 20540-13 TC	tk 20541-13
150 mm - 6"	tk 20540-15 TC	tk 20541-15
180 mm - 7"	tk 20540-18 TC	tk 20541-18
200 mm - 8"	tk 20540-20 TC	tk 20541-20
230 mm - 9"	tk 20540-23 TC	tk 20541-23
260 mm - 10 1/4"	tk 20540-26 TC	

MINI-RYDER

tk 20542-13 TC
tk 20542-15 TC
tk 20542-18 TC
tk 20542-20 TC
tk 20542-23 TC
tk 20542-26 TC



mit Spezialbeschichtung im Maul
 with special coated jaw

Mors avec couche special
 Boca con capa especial
 Morso "diamant dust"

Nadelhalter
Needle holders

Porte-aiguilles
Porta-agujas
Porta aghi

IV



CASTROVIEJO-
JACOBSON



140 mm - 5½"			tk 20210-14	tk 20710-14 TC
150 mm - 6"	tk 20204-15	tk 20704-15 TC	tk 20210-15	tk 20710-15 TC
180 mm - 7"	tk 20204-18	tk 20704-18 TC	tk 20210-18	tk 20710-18 TC
210 mm - 8¼"	tk 20204-21	tk 20704-21 TC	tk 20210-21	tk 20710-21 TC

glattes Maul
smooth jaws
mors lisse
boca lisa
morso liscio

gerade, ohne Sperre
straight, without ratchet
droit, sans crémaillère
recta, sin cremallera
retto, senza cremagliera

gerade, mit Sperre
straight, with ratchet
droit, avec crémaillère
recta, con cremallera
retto, con cremagliera



140 mm - 5½"			tk 20211-14	tk 20711-14 TC
150 mm - 6"	tk 20205-15	tk 20705-15 TC	tk 20211-15	tk 20711-15 TC
180 mm - 7"	tk 20205-18	tk 20705-18 TC	tk 20211-18	tk 20711-18 TC
210 mm - 8¼"	tk 20205-21	tk 20705-21 TC	tk 20211-21	tk 20711-21 TC

glattes Maul
smooth jaws
mors lisse
boca lisa
morso liscio

gebogen, ohne Sperre
curved, without ratchet
courbe, sans crémaillère
curva, sin cremallera
curvo, senza cremagliera

gebogen, mit Sperre
curved, with ratchet
courbe, avec crémaillère
curva, con cremallera
curvo, con cremagliera



BARRAQUER



1:1



1:1

145 mm - 5¾"	tk 20200-14	tk 20201-14
--------------	-------------	-------------

gerade
straight
droit
recta
retto

gebogen
curved
courbe
curva
curvo

1:2

Mikronadelhalter
Micro needle holders

Micro porte aiguilles
Micro porta agujas
Micro porta aghi



CASTROVIEJO

x = 11.0 mm x 0.75 mm

140 mm - 5½"

tk 40910-14

tk 40911-14

tk 40912-14

tk 40913-14

ohne Sperre, feines Maul
without ratchet, fine jaws

gerade
straight

gebogen
curved

gerade, diamantiert
straight, diamond coated

gebogen, diamantiert
curved, diamond coated

sans crémaillère, mors fine
sin cremallera, boca fina

droit
recta

courbe
curva

droit, diamanté
recta, diamantada

courbe, diamanté
curva, diamantada

senza cremagliera, morso fino

retto

curvo

retto, diamantato

curvo, diamantato

x = 11.0 mm x 0.75 mm

140 mm - 5½"

tk 40915-14

tk 40917-14

tk 40918-14

tk 40919-14

mit Sperre, feines Maul
with ratchet, fine jaws

gerade
straight

gebogen
curved

gerade, diamantiert
straight, diamond coated

gebogen, diamantiert
curved, diamond coated

avec crémaillère, mors fine
con cremallera, boca fina

droit
recta

courbe
curva

droit, diamanté
recta, diamantada

courbe, diamanté
curva, diamantada

con cremagliera, morso fino

retto

curvo

retto, diamantato

curvo, diamantato







1:1

Mikronadelhalter
Micro needle holders

Micro porte aiguilles
Micro porta agujas
Micro porta aghi







JACOBSON	 1:1	 1:1	 1:1	 1:1
	x = 1 mm	x = 1 mm	x = 1 mm	x = 1 mm
180 mm - 7"	tk 25740-01	tk 25740-02	tk 25740-13	tk 25740-14
ohne Sperre without ratchet	gerade straight	gebogen curved	gerade, diamantiert straight, diamond coated	gebogen, diamantiert curved, diamond coated
sans crémaillère sin cremallera senza cremagliera	droit recta retto	courbe curva curvo	droit, diamanté recta, diamantada retto, diamantato	courbe, diamanté curva, diamantada curvo, diamantato
	x = 1 mm	x = 1 mm	x = 1 mm	x = 1 mm
180 mm - 7"	tk 25740-03	tk 25740-04	tk 25740-15	tk 25740-16
mit Sperre with ratchet	gerade straight	gebogen curved	gerade, diamantiert straight, diamond coated	gebogen, diamantiert curved, diamond coated
avec crémaillère con cremallera con cremagliera	droit recta retto	courbe curva curvo	droit, diamanté recta, diamantada retto, diamantato	courbe, diamanté curva, diamantada curvo, diamantato



	 1:1	 1:1	 1:1	 1:1
	x = 1 mm	x = 1 mm	x = 1 mm	x = 1 mm
180 mm - 7"	tk 25740-05 tucar	tk 25740-06 tucar	tk 25740-09 tucar	tk 25740-10 tucar
ohne Sperre without ratchet	gerade, glatt straight, smooth	gebogen, glatt curved, smooth	gerade, gerieft straight, serrated	gebogen, gerieft curved, serrated
sans crémaillère sin cremallera senza cremagliera	droit, lisse recta, liso retto, liscio	courbe, lisse curva, lisa curvo, liscio	droit, strié recta, estriada retto, zigrinato	courbe, strié curva, estriada curvo, zigrinato
	x = 1 mm	x = 1 mm	x = 1 mm	x = 1 mm
180 mm - 7"	tk 25740-07 tucar	tk 25740-08 tucar	tk 25740-11 tucar	tk 25740-12 tucar
1 mm				
mit Sperre with ratchet	gerade, glatt straight, smooth	gebogen, glatt curved, smooth	gerade, gerieft straight, serrated	gebogen, gerieft curved, serrated
avec crémaillère con cremallera con cremagliera	droit, lisse recta, liso retto, liscio	courbe, lisse curva, lisa curvo, liscio	droit, strié recta, estriada retto, zigrinato	courbe, strié curva, estriada curvo, zigrinato

Mikronadelhalter mit Rundgriff
Micro needle holders with round handle

Micro porte aiguilles avec manche ronde
Micro porta agujas con mango redondo
 Micro porta aghi con manico rotondo

BARRAQUER		 1:1	 1:1	 1:1	 1:1
140 mm - 5½"	8 mm Ø	tk 25622-01	tk 25622-02	tk 25622-05	tk 25622-06
ohne Sperre, sehr feines Maul <i>without ratchet, extra delicate jaws</i>	gerade <i>straight</i>	gebogen <i>curved</i>	gerade, diamantiert <i>straight, diamond coated</i>	gebogen, diamantiert <i>curved, diamond coated</i>	
sans crémaillère, mors très fine <i>sin cremallera, boca muy fina</i>	droit <i>recta</i>	courbe <i>curva</i>	droit, diamanté <i>recta, diamantada</i>	courbe, diamanté <i>curva, diamantada</i>	
senza cremagliera, morso molto fino	retto	curvo	retto, diamantato	curvo, diamantato	
140 mm - 5½"	8 mm Ø	tk 25622-03	tk 25622-04	tk 25622-07	tk 25622-08
mit Sperre, sehr feines Maul <i>with ratchet, extra delicate jaws</i>	gerade <i>straight</i>	gebogen <i>curved</i>	gerade, diamantiert <i>straight, diamond coated</i>	gebogen, diamantiert <i>curved, diamond coated</i>	
avec crémaillère, mors très fine <i>con cremallera, boca muy fina</i>	droit <i>recta</i>	courbe <i>curva</i>	droit, diamanté <i>recta, diamantada</i>	courbe, diamanté <i>curva, diamantada</i>	
con cremagliera, morso molto fino	retto	curvo	retto, diamantato	curvo, diamantato	



1:1

Mikronadelhalter mit Rundgriff
Micro needle holders with round handle

Micro porte aiguilles avec manche ronde
Micro porta agujas con mango redondo
 Micro porta aghi con manico rotondo



110 mm - 4 1/4"	8 mm Ø	tk 25637-11	tk 25638-11
125 mm - 5"	7 mm Ø	tk 25654-12	tk 25655-12
130 mm - 5"	8 mm Ø	tk 25658-13	tk 25659-13
130 mm - 5"	10 mm Ø	tk 25652-13	tk 25653-13
150 mm - 6"	8 mm Ø	tk 25640-15	tk 25641-15
180 mm - 7"	8 mm Ø	tk 25664-18	tk 25665-18
180 mm - 7"	10 mm Ø	tk 25668-18	tk 25669-18

ohne Sperre
without ratchet
 sans crémaillère
sin cremallera
 senza cremagliera

gerade
straight
 droit
recta
 retto

gebogen
curved
 courbe
curva
 curvo

110 mm - 4 1/4"	8 mm Ø	tk 25635-11	tk 25636-11
125 mm - 5"	7 mm Ø	tk 25656-12	tk 25657-12
130 mm - 5"	8 mm Ø	tk 25662-13	tk 25663-13
130 mm - 5"	10 mm Ø	tk 25645-13	tk 25646-13
150 mm - 6"	8 mm Ø	tk 25642-15	tk 25643-15
180 mm - 7"	8 mm Ø	tk 25666-18	tk 25667-18
180 mm - 7"	10 mm Ø	tk 25670-18	tk 25671-18

mit Sperre
with ratchet
 avec crémaillère
con cremallera
 con cremagliera





gerade
straight
 droit
recta
 retto

gebogen
curved
 courbe
curva
 curvo

Mikronadelhalter mit Rundgriff
Micro needle holders with round handle





Micro porte aiguilles avec manche ronde
Micro porta agujas con mango redondo
 Micro porta aghi con manico rotondo



YASARGIL	 1:1	 1:1	 1:1	 1:1
	x = 1 mm	x = 1 mm	x = 1 mm	x = 1 mm
210 mm - 8 1/4"	tk 25623-01	tk 25623-02	tk 25623-13	tk 25623-14
ohne Sperre <i>without ratchet</i>	gerade <i>straight</i>	gebogen <i>curved</i>	gerade, diamantiert <i>straight, diamond coated</i>	gebogen, diamantiert <i>curved, diamond coated</i>
sans crémaillère <i>sin cremallera</i>	droit <i>recta</i>	courbe <i>curva</i>	droit, diamanté <i>recta, diamantado</i>	courbe, diamanté <i>curva, diamantado</i>
senza cremagliera	retto	curvo	retto, diamantato	curvo, diamantato

	x = 1 mm	x = 1 mm	x = 1 mm	x = 1 mm
210 mm - 8 1/4"	tk 25623-03	tk 25623-04	tk 25623-15	tk 25623-16
mit Sperre <i>with ratchet</i>	gerade <i>straight</i>	gebogen <i>curved</i>	gerade, diamantiert <i>straight, diamond coated</i>	gebogen, diamantiert <i>curved, diamond coated</i>
avec crémaillère <i>con cremallera</i>	droit <i>recta</i>	courbe <i>curva</i>	droit, diamanté <i>recta, diamantada</i>	courbe, diamanté <i>curva, diamantada</i>
con cremagliera	retto	curvo	retto, diamantato	curvo, diamantato



	 1:1	 1:1	 1:1	 1:1
	x = 1 mm	x = 1 mm	x = 1 mm	x = 1 mm
210 mm - 8 1/4"	tk 25623-05 tucar	tk 25623-06 tucar	tk 25623-09 tucar	tk 25623-10 tucar
ohne Sperre <i>without ratchet</i>	gerade, glatt <i>straight, smooth</i>	gebogen, glatt <i>curved, smooth</i>	gerade, gerieft <i>straight, serrated</i>	gebogen, gerieft <i>curved, serrated</i>
sans crémaillère <i>sin cremallera</i>	droit, lisse <i>recta, lisa</i>	courbe, lisse <i>curva, lisa</i>	droit, strié <i>recta, estriada</i>	courbe, strié <i>curva, estriada</i>
senza cremagliera	retto, liscio	curvo, liscio	retto, zigrinato	curvo, zigrinato

	x = 1 mm	x = 1 mm	x = 1 mm	x = 1 mm
210 mm - 8 1/4"	tk 25623-07 tucar	tk 25623-08 tucar	tk 25623-11 tucar	tk 25623-12 tucar
mit Sperre <i>with ratchet</i>	gerade, glatt <i>straight, smooth</i>	gebogen, glatt <i>curved, smooth</i>	gerade, gerieft <i>straight, serrated</i>	gebogen, gerieft <i>curved, serrated</i>
avec crémaillère <i>con cremallera</i>	droit, lisse <i>recta, lisa</i>	courbe, lisse <i>curva, lisa</i>	droit, strié <i>recta, estriada</i>	courbe, strié <i>curva, estriada</i>
con cremagliera	retto, liscio	curvo, liscio	retto, zigrinato	curvo, zigrinato



Auf Anfrage mit kräftigem Maul 1.5 mm - 2.0 mm lieferbar.
On request also available with stronger jaw 1.5 mm - 2.0 mm.

Egalement disponible avec mors plus gros 1.5 mm - 2.0 mm.
También disponible con boca mas fuerte 1.5 mm - 2.0 mm.

A richiesta fornibile anche con morso più forte di mm 1.5 a mm 2.0.

Mikronadelhalter
Micro needle holders

Micro porte aiguilles
Micro porta agujas
Micro porta aghi



Das 2 in 1 System erlaubt die Benutzung der Nadelhalter, selbst während des Eingriffs, mit Sperre (Fig. A) oder ohne Sperre (Fig. B). Außer dem wirtschaftlichen Aspekt, der für dieses System spricht, erhöht sich auch die Zuverlässigkeit der Instrumente.

The 2 in 1 system allows to switch intraoperatively from lock (Fig. A) to lock free (Fig. B) use of the needle holder.

In addition to cost effectiveness, this new concept provides better reliability.

Le système 2 in 1 permet d'utiliser, même en cours d'intervention, les porte-aiguille avec verrou (Fig. A) ou sans verrou (Fig. B). En dehors de l'aspect économique, ce nouveau concept apporte une plus grande fiabilité.

El sistema 2 in 1 permite utilizar el portaaguja con cerrojo (Fig. A) o sin cerrojo (Fig. B) incluso durante la intervención. Aparte del aspecto económico, este nuevo concepto aporta una mayor fiabilidad.

Il sistema 2 in 1 permette di utilizzare, anche in corso d'intervento il portaghi con la chiusura (Fig. A) o senza (Fig. B). Questo nuovo concetto assicura una maggiore affidabilità.



Fig. A



Fig. B

Mikronadelhalter
Micro needle holders

Micro porte aiguilles
Micro porta agujas
Micro porta aghi



	0.4 x 0.6 mm	0.4 x 0.6 mm	0.6 x 0.6 mm	0.6 x 0.6 mm
200 mm - 8"	tk 25685-13	tk 25685-14	tk 25685-15	tk 25685-16

Titan, mit Sperre
Titanium, with ratchet
Titane, avec crémaillère
Titanio, con cremallera
Titanio, con cremagliera

Mikronadelhalter
Micro needle holders

Micro porte aiguilles
Micro porta agujas
Micro porta aghi

TITANTK



	0.3 mm x 0.4 mm	0.3 mm x 0.4 mm
180 mm - 7"	tk 25685-07	tk 25685-08

Titan, mit Sperre
Titanium, with ratchet
Titane, avec crémaillère
Titanio, con cremallera
Titanio, con cremagliera



	0.8 mm x 0.8 mm	0.8 mm x 0.8 mm
185 mm - 7 1/4"	tk 25685-09	tk 25685-10

Titan, mit Sperre
Titanium, with ratchet
Titane, avec crémaillère
Titanio, con cremallera
Titanio, con cremagliera

Hämmer | **Maillets**
Mallets | **Martillos**
Martelli

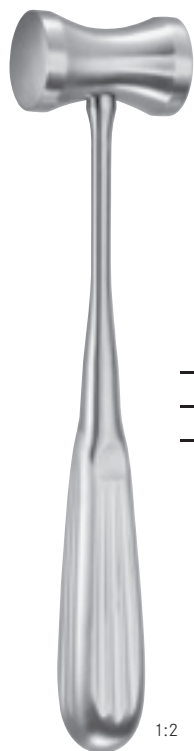

1:2

H A J E K	
	27 mm Ø - 140 g
215 mm - 8½"	tk 24047-21

Stahl massiv
Steel solid
 Acier solide
 Acero solido
 Acciaio massiccio



1:2

C O L L I N	
	30 mm Ø - 220 g
200 mm - 8"	tk 24051-20

Stahl massiv
Steel solid
 Acier solide
 Acero solido
 Acciaio massiccio

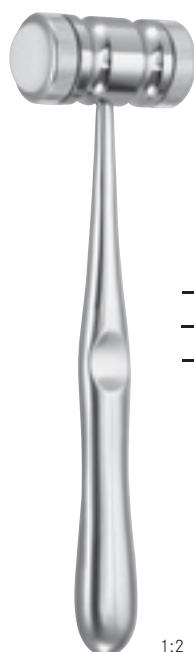

1:2

M E A D		
	26 mm Ø - 320 g	26 mm Ø - 320 g
170 mm - 6¾"	tk 24050-17	tk 24050-90

Stahl massiv, mit Ferrozellbacken <i>Steel solid, with Ferrozell faces</i>	Ersatzbacken, 1 Paar <i>Spare faces, 1 pair</i>
Acier solide, avec plaques en Ferrozell	Plaques de rechange, 1 paire
Acero solido, con placas en Ferrozell	Placas de cambio, 1 par
Acciaio massiccio, con punte di Ferrozell	Placche di ricambio, 1 paia

Hämmer
Mallets

Maillets
Martillos
Martelli



PARTSCH

	22 mm Ø - 200 g
180 mm - 7"	tk 24053-18

1:2



1:2

	20 mm Ø - 140 g
165 mm - 6½"	tk 24055-16

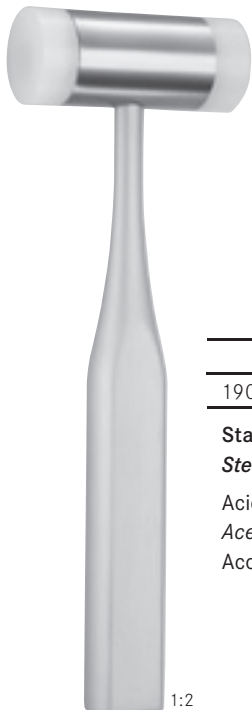

1:2

	25 mm Ø - 205 g
190 mm - 7½"	tk 24056-19

Stahl massiv, mit Kunststoffbacken
Steel solid, with plastic faces

Acier solide, avec plaques en plastic
Acero solido, con placas en plastica
Acciaio massiccio, con placche di plastica



1:2

LUCAE

	19 mm Ø - 230 g	25 mm Ø - 260 g
190 mm - 7½"	tk 24057-01	tk 24057-02

Stahl massiv
Steel solid

Acier solide
Acero solido
Acciaio massiccio

Meißel zur Nasenplastik
Chisels, osteotomes for rhinoplastic

Ostéotomes, ciseaux-burins pour rhinoplastique
Cinceles para rinoplastica
 Scalpelli per plastica nasale



KILIAN

	5 mm
160 mm - 6 1/4"	tk 24261-16



KILIAN-CLAUS

	5 mm
160 mm - 6 1/4"	tk 24263-16



COTTLE

	7 mm	12 mm
150 mm - 6"	tk 24270-07	tk 24270-12



1:2



COTTLE

	4 mm
190 mm - 7 1/2"	tk 24272-19



1:2



COTTLE

	6 mm
180 mm - 7"	tk 24277-06

Meißel zur Nasenplastik
Chisels, osteotomes for rhinoplastic

Ostéotomes, ciseaux-burins pour rhinoplastique
Cinceles para rinoplastica
Scalpelli per plastica nasale



1:1



1:1



1:1



1:1

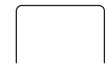

1:1

COTTLE

	4 mm	7 mm	9 mm	12 mm
180 mm - 7"	tk 24280-04	tk 24280-07	tk 24280-09	tk 24280-12

1:2



1:1



1:1



1:1



1:1



1:1

COTTLE

	4 mm	7 mm	9 mm	12 mm
180 mm - 7"	tk 24281-04	tk 24281-07	tk 24281-09	tk 24281-12

1:2

Meißel zur Nasenplastik
Chisels, osteotomes for rhinoplastic

Ostéotomes, ciseaux-burins pour rhinoplastique
Cinceles para rinoplastica
 Scalpelli per plastica nasale



1:2

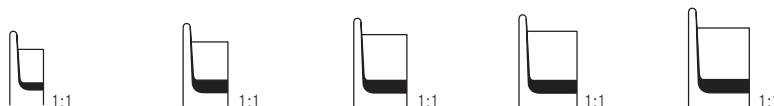

FOMON

	4 mm	5 mm	6 mm	7 mm	8 mm
170 mm - 6 3/4"	tk 24278-04	tk 24278-05	tk 24278-06	tk 24278-07	tk 24278-08



1:2

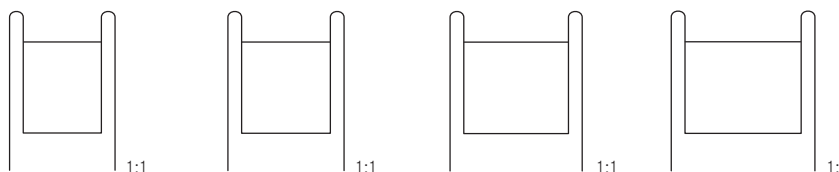

CINELLI

	10 mm	12 mm	14 mm	16 mm
180 mm - 7"	tk 24279-10	tk 24279-12	tk 24279-14	tk 24279-16

Meißel zur Nasenplastik
Chisels, osteotomes for rhinoplastic

Ostéotomes, ciseaux-burins pour rhinoplastique
Cinceles para rinoplastica
Scalpelli per plastica nasale

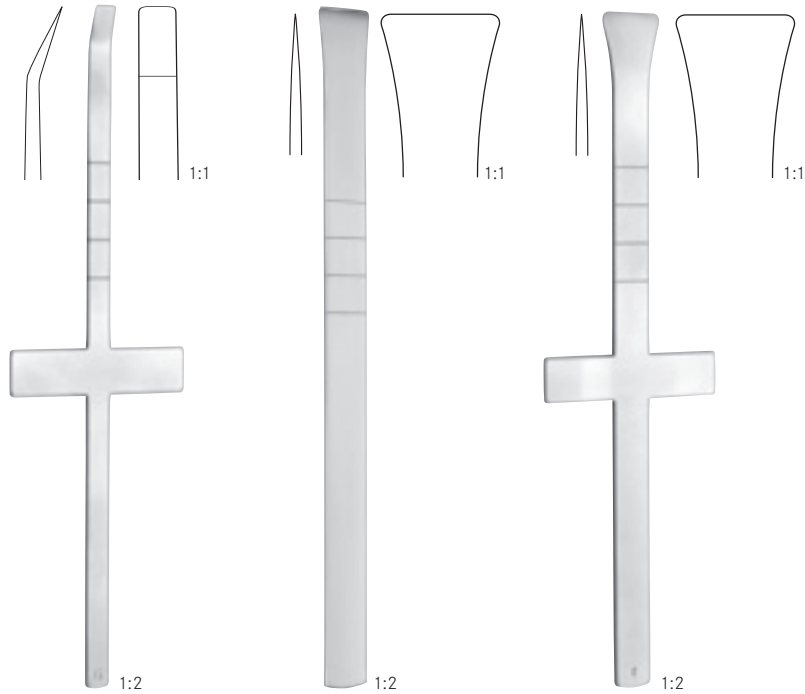

COTTLE

	6 mm	16 mm	16 mm
180 mm - 7"	tk 24283-06	tk 24284-16	tk 24286-16



COTTLE

	4 mm	7 mm	9 mm	12 mm
200 mm - 8"	tk 24287-04	tk 24287-07	tk 24287-09	tk 24287-12

Meißel zur Nasenplastik
Chisels, osteotomes for rhinoplastic

Ostéotomes, ciseaux-burins pour rhinoplastique
Cinceles para rinoplastica
Scalpelli per plastica nasale

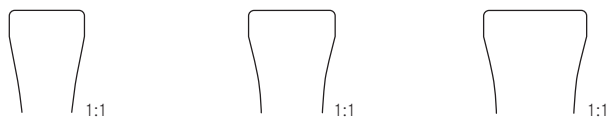

RUBIN

	10 mm	12 mm	14 mm
180 mm - 7"	tk 24290-10	tk 24290-12	tk 24290-14

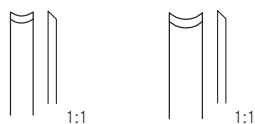

WALTER

	3 mm	4,5 mm
190 mm - 7½"	tk 24292-03	tk 24292-04

Meißel zur Nasenplastik
Chisels, osteotomes for rhinoplastic

Ostéotomes, ciseaux-burins pour rhinoplastique
Cinceles para rinoplastica
Scalpelli per plastica nasale

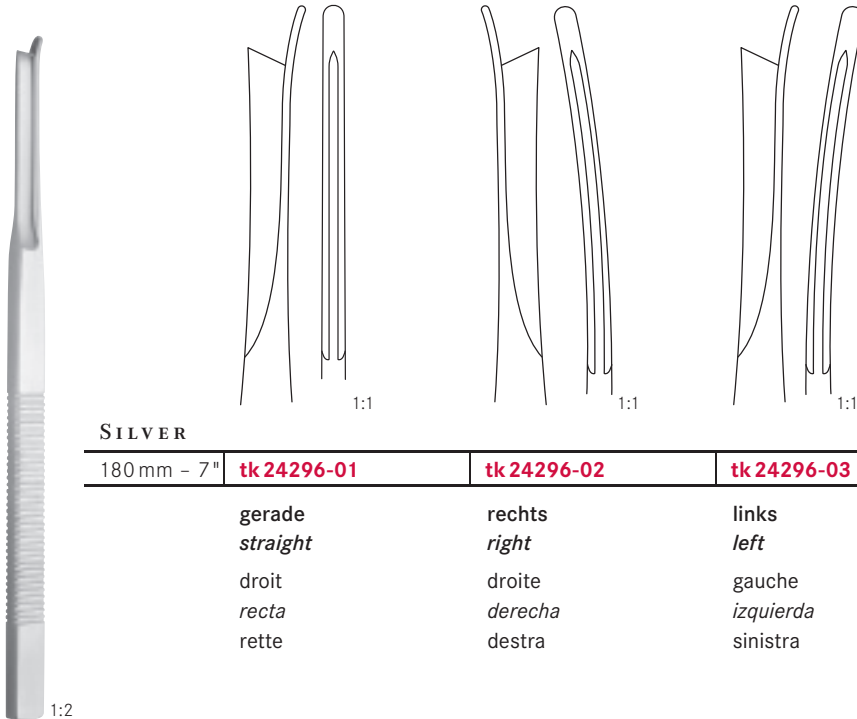

SILVER

180 mm - 7"	tk 24296-01	tk 24296-02	tk 24296-03
	gerade straight	rechts right	links left
	droit recta	droite derecha	gauche izquierda
	rette	destra	sinistra

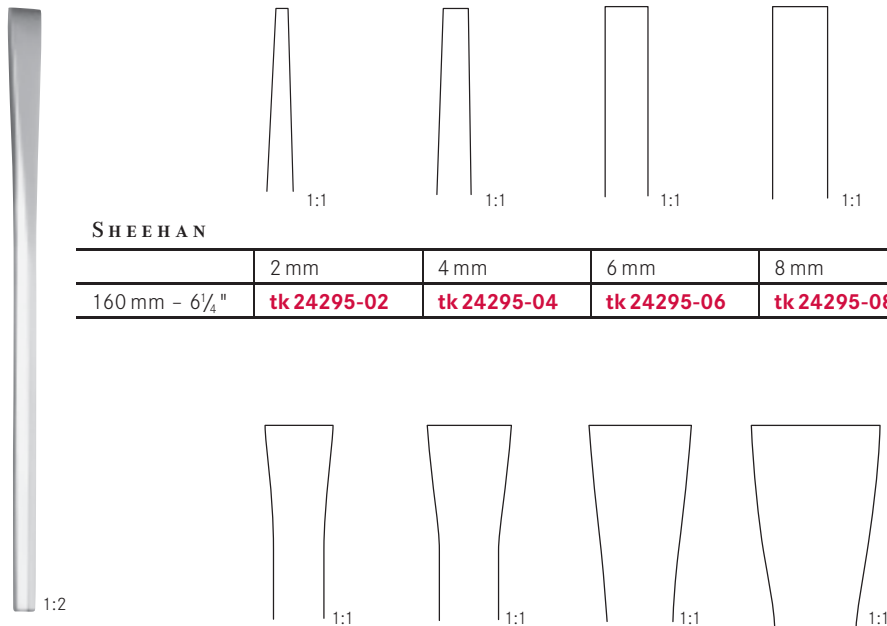

SHEEHAN

	2 mm	4 mm	6 mm	8 mm
160 mm - 6¼"	tk 24295-02	tk 24295-04	tk 24295-06	tk 24295-08

	10 mm	12 mm	15 mm	18 mm
160 mm - 6¼"	tk 24295-10	tk 24295-12	tk 24295-15	tk 24295-18

Meißel zur Nasenplastik
Chisels, osteotomes for rhinoplastic

Ostéotomes, ciseaux-burins pour rhinoplastique
Cinceles para rhinoplastica
 Scalpelli per plastica nasale

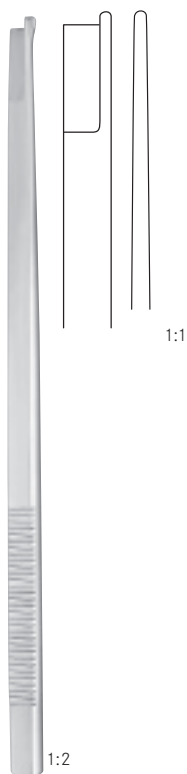

NEIVERT

200 mm - 8"

tk 24298-01

- gerade
- straight*
- droit
- recta*
- rette

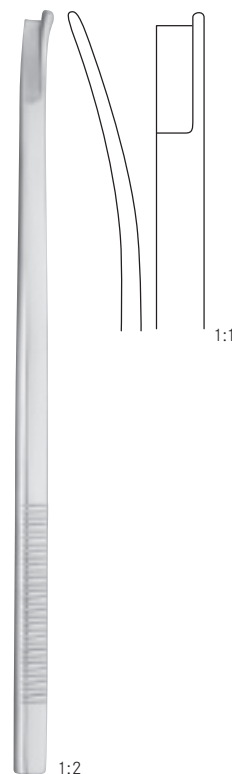

NEIVERT-ANDERSON

200 mm - 8"

tk 24298-02

- rechts
- right*
- droite
- derecha*
- destra

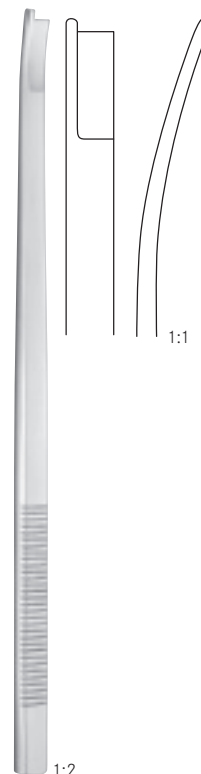

tk 24298-03

- links
- left*
- gauche
- izquierda*
- sinistra

Septum-Elevatorien
Septum elevators

Elevateurs pour la cloison nasale
Elevadores para el tabique nasal
Elevatori per setto

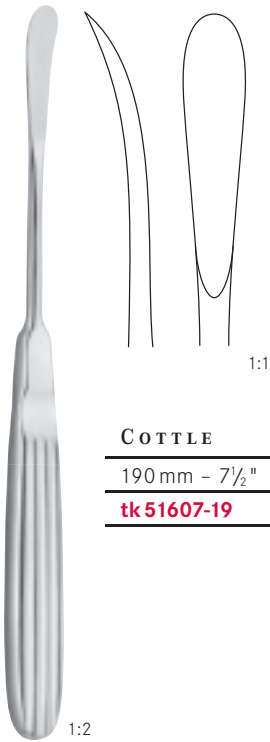

COTTLE

190 mm - 7½"

tk 51607-19

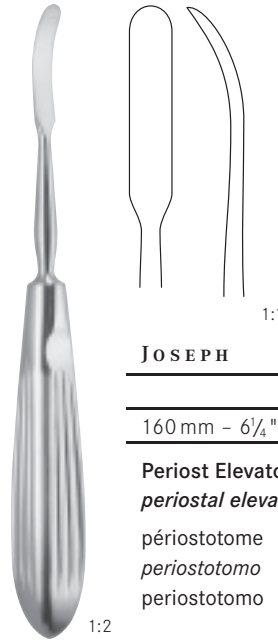

JOSEPH

4 mm

160 mm - 6¼"

tk 51613-16

Periost Elevatorium
periostal elevator

périostotome
periostotomo
periostotomo



HALLE

160 mm - 6¼"

tk 51617-16



BALLENGER-HAJEK

190 mm - 7½"

tk 51637-19

220 mm - 8¾"

tk 51637-22

Septum-Elevatorien
Septum elevators

Elevateurs pour la cloison nasale
Elevadores para el tabique nasal
Elevatori per setto



FREER

190 mm - 7½"

tk 51625-19

stumpf
blunt

mousse
roma
smussa

1:2

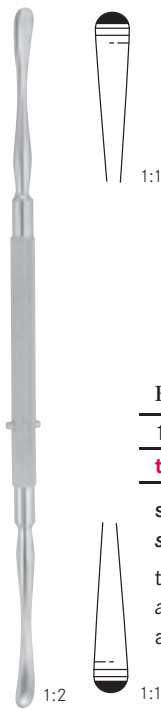

FREER

180 mm - 7"

tk 51627-18

scharf/stumpf
sharp/blunt

tranchant/mousse
aguda/roma
acuta/smussa

1:2

1:1

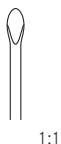

1:1

COTTLE

2.5 mm

160 mm - 6¼"

tk 51646-02

1:2

Septum-Elevatorien
Septum elevators

Elevateurs pour la cloison nasale
Elevadores para el tabique nasal
Elevatori per setto



200 mm - 8" **tk 51645-20**

Saug-Raspatorium - biegsam, scharf
suction raspatory - malleable, sharp
rugine aspirante - flexible, tranchant
legra aspiradora - maleable y agudo
elevatore-aspiratore - flessibile, tagliente

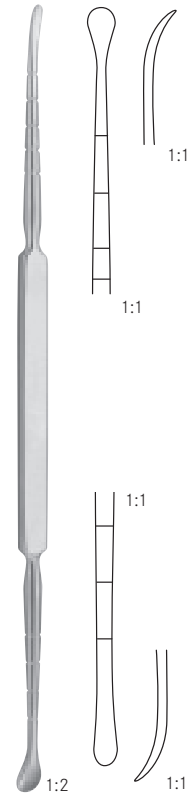

COTTLE

210 mm - 8 1/4"

tk 51644-21

Septum-Elevatorien
Septum elevators

Elevateurs pour la cloison nasale
Elevadores para el tabique nasal
Elevatori per setto

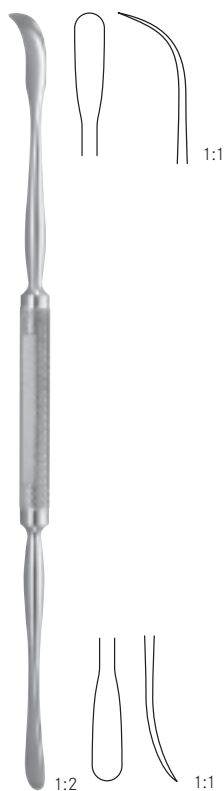

FREER

205 mm - 8"

tk 51631-20

scharf/stumpf
sharp/blunt

tranchant/mousse
aguda/roma
acuta/smussa

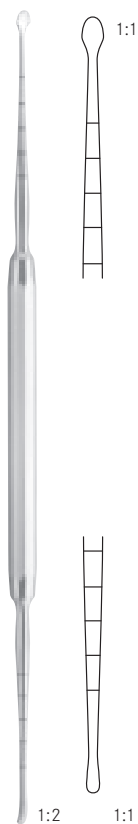

MASING

200 mm - 8

tk 51636-21



COTTLE

220 mm - 8 3/4"

tk 51643-22

Raspatorien und Ahlen für die Kieferchirurgie
Periosteal elevators and awls for maxillo-facial surgery

Rugines, décolleurs et passe-fils pour chirurgie maxillo-faciale
Periostótomos y leznas para maxillofacial
Raspatori, punteruoli per chirurgia massilofaciale



1:1



1:1



1:1



1:1

OBWEGESER

	6 mm	7 mm	9 mm	11 mm
175 mm - 7"	tk 52730-06	tk 52730-07	tk 52730-09	tk 52730-11

1:2



1:1

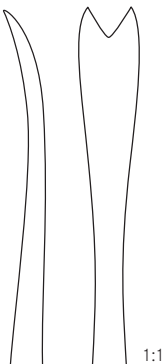

1:1

OBWEGESER

175 mm - 7"

tk 52735-01

1:2



1:1

1:2

OBWEGESER

180 mm - 7"

tk 52749-18



1:1

1:2

OBWEGESER

140 mm - 5½"

tk 52750-14



1:2

OBWEGESER

230 mm - 8"

tk 52751-23

Raspatorien - Elevatorien
Periosteal raspatories - Elevators

Rugines - Elevateurs
Raspatorios - Elevadores
 Periostotomi - Elevatori

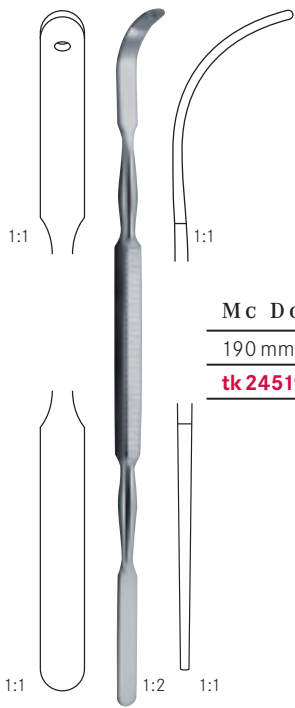

Mc DONALD
 190 mm - 7½"
tk 24519-19



WATSON-CHEYNE
 190 mm - 7½"
tk 24529-19

Meißel für die Kieferchirurgie
Osteotomes for maxillo-facial surgery

Ostéotomes pour chirurgie maxillo-faciale
Cinceles para maxilofacial
Scalpelli per chirurgia massilofaciale



OBWEGESER

	7 mm	10 mm
215 mm - 8½"	tk 52755-21	tk 52756-21

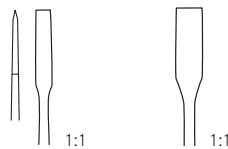

OBWEGESER

	2,5 mm	4 mm
150 mm - 6"	tk 52742-25	tk 52742-40

Raspatorien, Meißel für die Kieferchirurgie
Periosteal elevators, osteotomes for maxillo-facial surgery

Rugines, ostéotomes pour chirurgie maxillo-faciale
Periostótomos, cinceles para maxilofacial
 Raspatori, scalpelli per chirurgia massilofaciale

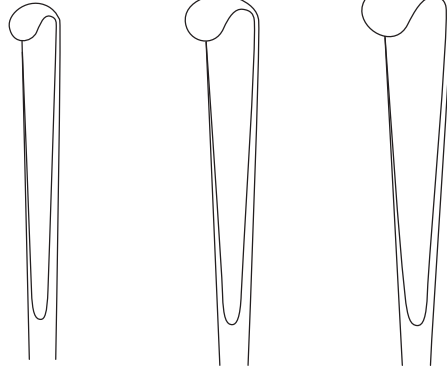

OBWEGESER

	5 mm	8 mm	9 mm
200 mm - 8"	tk 52731-05	tk 52731-08	tk 52731-09



OBWEGESER

210 mm - 8 1/4"
tk 52738-21



OBWEGESER

210 mm - 8 1/4"
tk 52740-21



OBWEGESER

235 mm - 9 1/4"
x = 11 mm
tk 52744-24



OBWEGESER

185 mm - 7 1/4"
tk 52746-19



OBWEGESER

185 mm - 7 1/4"
tk 52747-19

Nasenspekula
Nasal specula

Spéculums nasaux
Especulos nasales
Specoli nasali

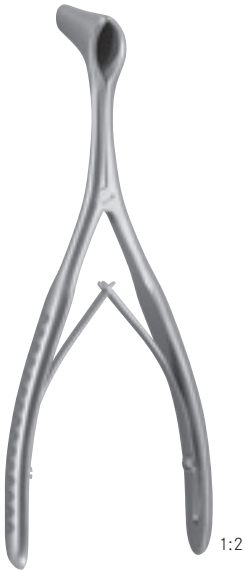

HARTMANN-HALLE

150 mm - 6"

tk 50813-01

tk 50813-02

tk 50813-03

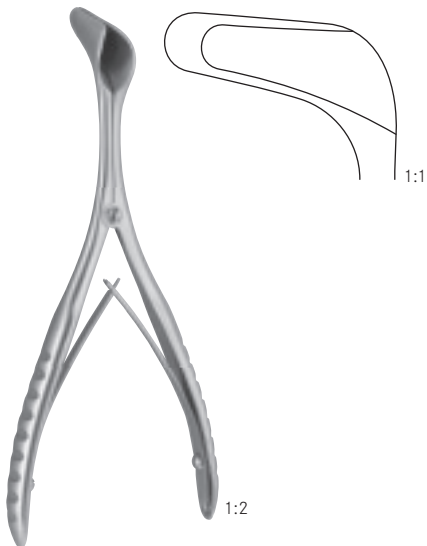
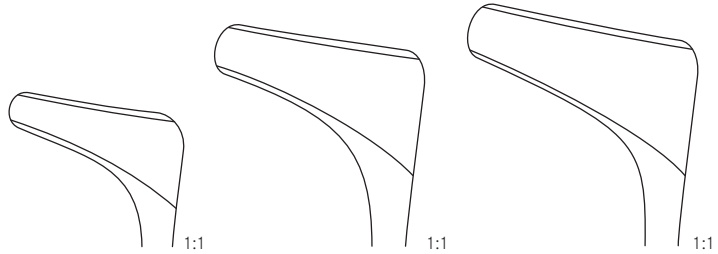

SCHWARZ

140 mm - 5½"

tk 50811-14



TIECK-HALLE

135 mm - 5¼"

tk 50823-13



Alle Nasenspekula sind optional auch mit Feststellschraube erhältlich

All nasal specula are also available with locking screw

Tous les spéculums nasaux sont aussi disponible avec une vis de fixation

Todos los especulos nasales son también disponibles con un tornillo de fijación

Tutti gli specoli nasali sono disponibili anche con vite di fassaggio



Nasenspekula | Spéculums nasaux
Nasal specula | Espéculos nasales
 Specoli nasali

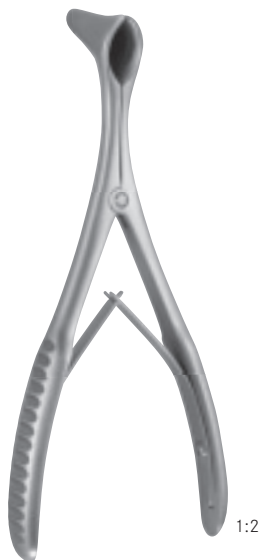

1:2

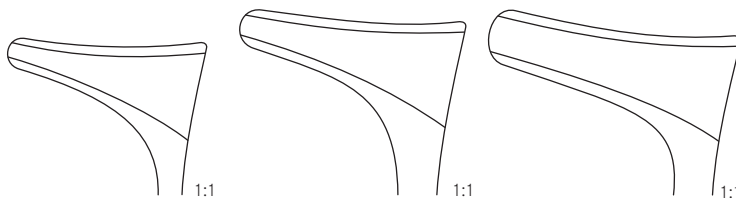

MODELL WIEN

145 mm - 5 3/4"	tk 50834-01	tk 50834-02	tk 50834-03
-----------------	--------------------	--------------------	--------------------



1:2

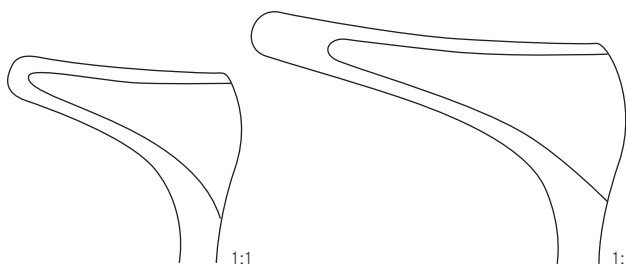

COTTLE

	x = 35 mm	x = 50 mm
150 mm - 6"	tk 50836-35	tk 50836-50

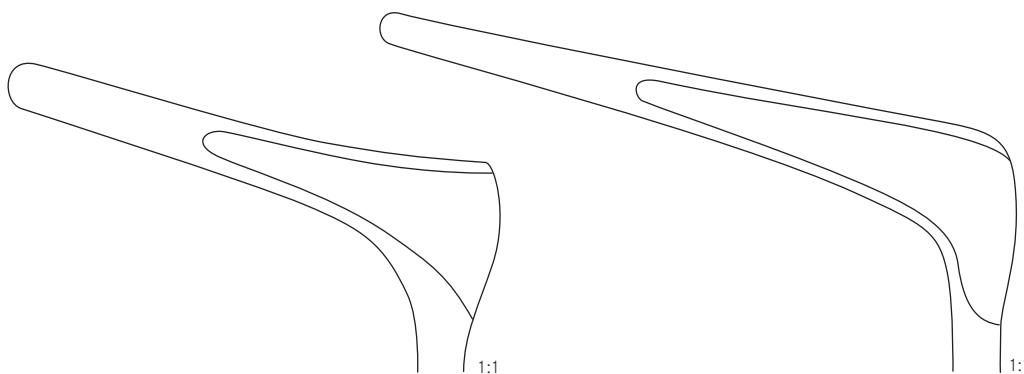

COTTLE

	x = 75 mm	x = 90 mm
150 mm - 6"	tk 50836-75	tk 50836-90

Nasenspekula
Nasal specula

Spéculums nasaux
Espéculos nasales
Specoli nasali

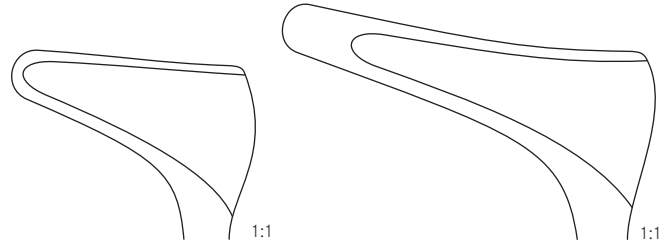

KILIAN

	x = 35 mm	x = 50 mm
130 mm - 5"	tk 50828-01	tk 50828-02

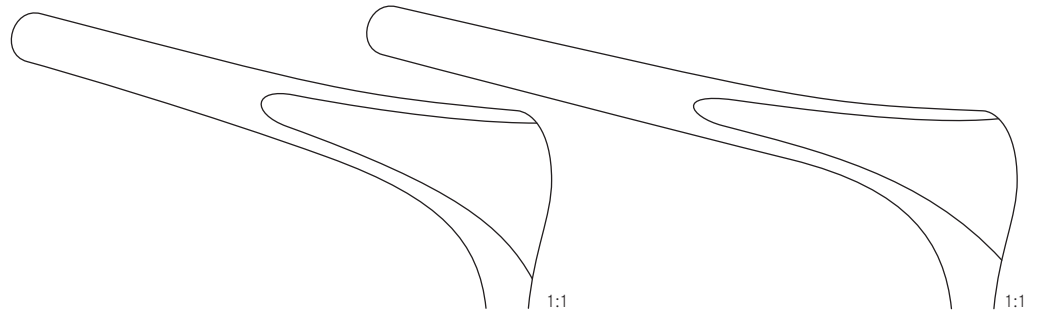

	x = 75 mm	x = 90 mm
130 mm - 5"	tk 50828-03	tk 50828-04

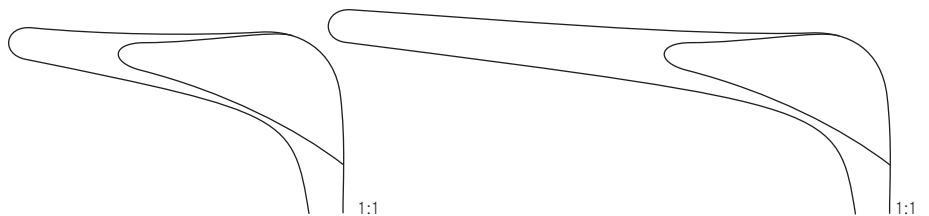

COTTLE

	x = 45 mm	x = 75 mm
140 mm - 5½"	tk 50840-45	tk 50840-75

schwarz verchromt
black, chrome plated
chromé en noir
chromado en negro
cromato nero

Nasensägen
Nasal saws

Scies nasales
Sierras nasales
Seghe nasali



JOSEPH

170 mm - 6³/₄"

tk 51655-20

tk 51657-20



JOSEPH

190 mm - 7¹/₂"

tk 51661-01

tk 51661-02

Nasenraspeln
Nasal rasps

Râpes nasales
Limas nasales
Raspe nasali



AUFRICHT

210 mm - 8 1/4" **tk 51672-21**

auf Zug und auf Stoss schneidend
drawing and pushing cut

tranchant à traction et en poussant
cortante a tracción y empuje
tagliente a trazione e a urto

1:2

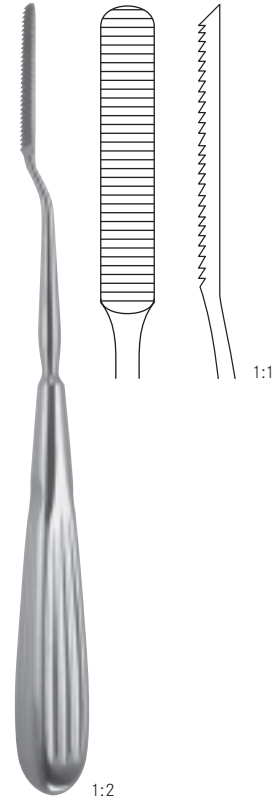

COTTLE

210 mm - 8 1/4"

tk 51665-21

1:2

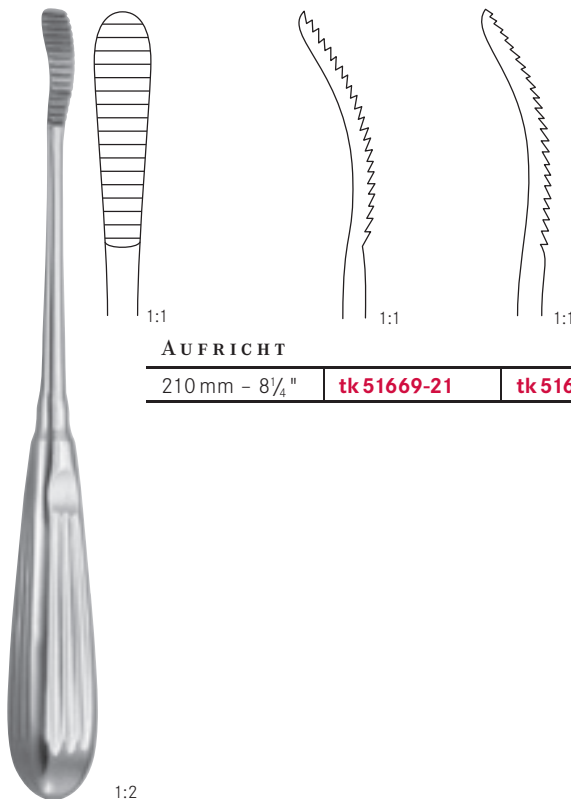

AUFRICHT

210 mm - 8 1/4" **tk 51669-21** **tk 51671-21**

1:2

11

Nasenraspeln | Râpes nasales
Nasal rasps | *Limas nasales*
 Raspe nasali

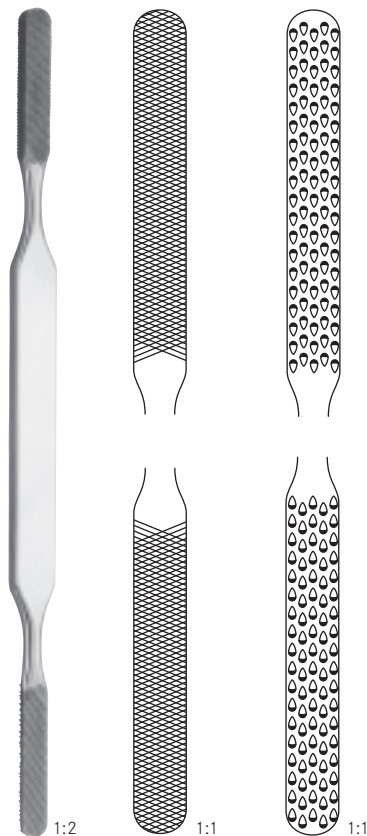

FOMON
 210 mm - 8 1/4"
tk 51685-21

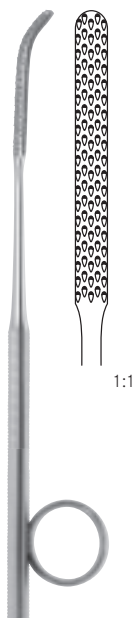

GALLAHER			
160 mm - 6 1/4"	tk 51683-01	tk 51683-02	tk 51683-03

Raspeln mit Hartmetall
Rasps with tungsten carbide

Râpes avec inserts de carbure de tungstène
Limas con carburo de tungsteno
Raspe con tungsteno

TUCAR **TK**

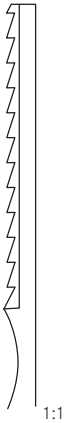

1:1



1:1



1:1



1:1



1:1



1:1

Fig. 1	Fig. 3	Fig. 5	Fig. 7	Fig. 9
12	16	24	36	52

Zähne

Teeth

Dentes

Dientes

Denti

FOMON TC

200 mm - 8"	tk 51686-01 tucar	tk 51686-03 tucar	tk 51686-05 tucar	tk 51686-07 tucar	tk 51686-09 tucar
-------------	--------------------------	--------------------------	--------------------------	--------------------------	--------------------------



1:1



1:1



1:1



1:1



1:1

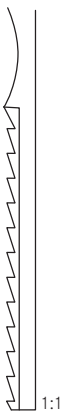

1:1

1:1

Fig. 2	Fig. 4	Fig. 6	Fig. 8	Fig. 10
14	20	30	44	62

Zähne

Teeth

Dentes

Dientes

Denti



HOCHFREQUENZKABEL
HIGH FREQUENCY CABLES

Wiegung - Hochfrequenzkabel, unidirektional (30°), 27V
 Weighing - High Frequency cable, unidirectional (30°), 27V

4 m / cable code / code	HF-01-04
6 m / cable code / code	HF-01-06

Baugruppe
 design

Wiegung
 design

TK-TEKNO

Herstellerangaben sind zu befolgen.
 Herstellerangaben sind zu befolgen.
 Please observe instructions.

TK-TEKNO

Herstellerangaben sind zu befolgen.
 Herstellerangaben sind zu befolgen.
 Please observe instructions.

ELEKTRODEN
ELECTRODES

1.1 / 1.1	2.1 / 2.1	3.1 / 3.1
2.2 / 2.2	3.2 / 3.2	4.2 / 4.2

Baugruppe
 design

TK-TEKNO

Herstellerangaben sind zu befolgen.
 Herstellerangaben sind zu befolgen.
 Please observe instructions.

ZUBEHÖRE
ACCESSORIES

1.1	1.2	1.3
1.4	1.5	1.6

Baugruppe
 design

TK-TEKNO

Herstellerangaben sind zu befolgen.
 Herstellerangaben sind zu befolgen.
 Please observe instructions.

ZUBEHÖRE
ACCESSORIES

Wiegung
 design

TK-TEKNO

Herstellerangaben sind zu befolgen.
 Herstellerangaben sind zu befolgen.
 Please observe instructions.

TK-TEKNO

Herstellerangaben sind zu befolgen.
 Herstellerangaben sind zu befolgen.
 Please observe instructions.

TK-TEKNO

Herstellerangaben sind zu befolgen.
 Herstellerangaben sind zu befolgen.
 Please observe instructions.

TK-TEKNO

HF-CERAT TOM 80
HF-SUIT TOM 80

TK-TEKNO

Herstellerangaben sind zu befolgen.
 Herstellerangaben sind zu befolgen.
 Please observe instructions.

Für weitere Informationen, fragen Sie bitte nach unserem Spezial-Katalog!
 For further information, please ask for our special catalogue!
 Pour plus d'information, veuillez demander pour notre catalogue spécial!
 Para mas información pueden preguntar para nuestro catálogo especial!
 Per ulteriore informazioni, per favore domandate per il nostro catalogo speciale!

Septumzangen
Septum forceps

Pinces pour la cloison nasale
Pinzas para el tabique nasal
Pinze per il setto nasale

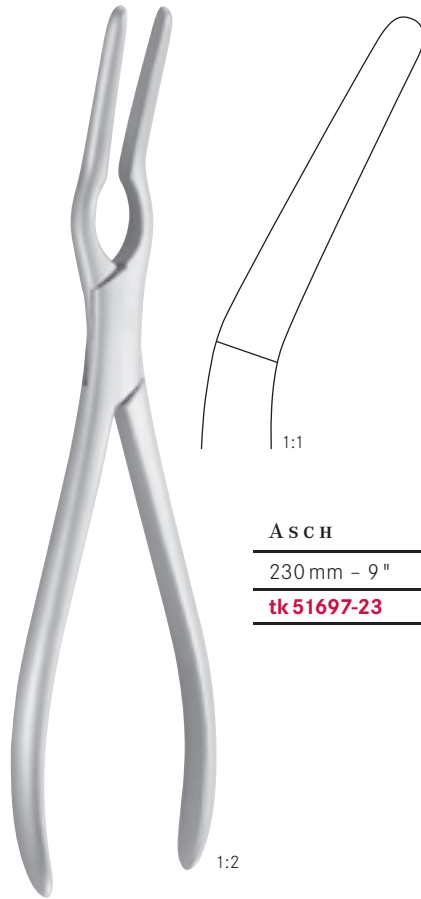

ASCH

230 mm - 9"

tk 51697-23

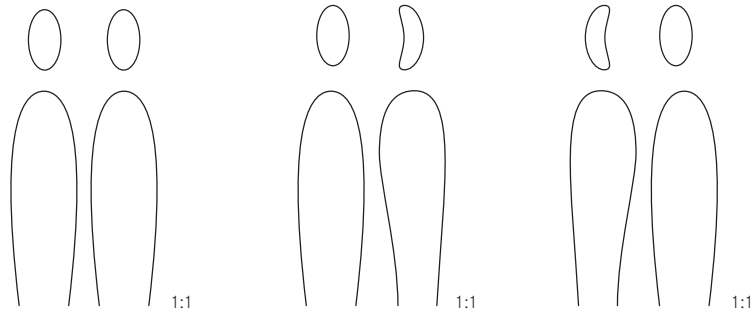

COTTLE-WALSHAM

230 mm - 9"	tk 51695-01	tk 51695-02	tk 51695-03
gerade <i>straight</i>	links <i>left</i>	rechts <i>right</i>	
droit <i>recta</i> rette	gauche <i>izquierda</i> a sinistra	droite <i>derecha</i> a destra	

1:2

Septumzangen
Septum forceps

Pinces pour la cloison nasale
Pinzas para el tabique nasal
Pinze per il setto nasale



1:2



1:1

MIDDLETON-JANSEN

190 mm - 7½" **tk51180-19**



1:2

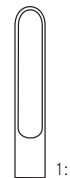

1:1

MIDDLETON-JANSEN

190 mm - 7½" **tk51182-19**



1:2

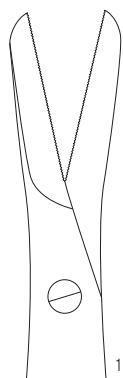

1:1

CAPLAN

200 mm - 8" **tk51184-20**

gezahnt
toothed
dentelée
dentado
dentato



1:2



1:1

RUBIN

210 mm - 8¼" **tk51188-21**



tk51188-01

Schutzkappe
Protection Cap
Capuchon protecteur
Caperuza protectora
Calotta protettiva

Sehnenstripper
Tendon strippers

Instruments à écorcher les tendons
Enucleadores de tendones
Scollatendini



	1:1	1:1	1:1
	4.0 mm Ø	4.5 mm Ø	5.5 mm Ø
230 mm - 9"	tk 24578-40	tk 24578-45	tk 24578-55

Schaft biegsam
Malleable shaft
Tige malléable
Tija maleable
Asta malleabile

1:2



BUNNELL	1:1	1:1	1:1
	Fig. 1	Fig. 2	Fig. 3
150 mm - 6"	tk 24575-01	tk 24575-02	tk 24575-03

1:1	1:1
Fig. 4	Fig. 5
tk 24575-04	tk 24575-05

1:2

11

Sehnenstripper
Tendon strippers

Instruments à écorcher les tendons
Enucleadores de tendones
Scollatendini



FISCHER
310 mm - 12 1/4"
tk 24580-31



BUNNELL
230 mm - 9"
tk 24582-23





**KLEINERT-
KUTZ**
200 mm - 8"
20 mm Ø
tk 24588-20

Sehnedurchzugs-sonde
Tendon passer
Sonde conductrice pour tendons
Sonda conductora de tendones
Sonda conduttrice per tendini

Sehnenfazzangen
Tendon holding forceps

Pinces pour saisir les tendons
Pinzas para coger tendones
Pinze per afferrare tendini



BRAND	 1:1	 1:1	 1:1
	150 mm - 6"	190 mm - 7½"	240 mm - 9½"
	tk 24585-15	tk 24585-19	tk 24585-24

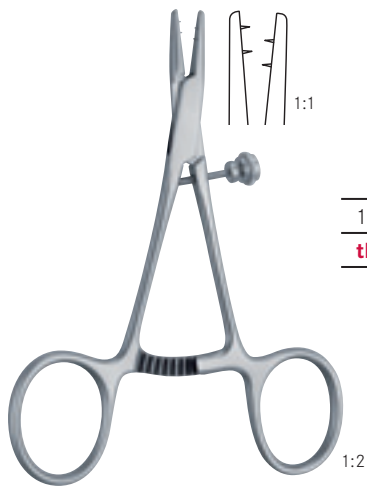

130 mm - 5"
tk 38724-13

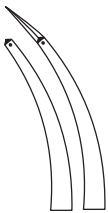

 1:1	 1:1
150 mm - 6"	tk 24589-15
	tk 24590-15

Sehnenfasszangen
Tendon holding forceps

Pinces pour saisir les tendons
Pinzas para coger tendones
Pinze per afferrare tendini



1:2



1:1

1:1

205 mm - 8"

tk 24586-00

tk 24586-01

Sehnedurchzugszange
Tendon passer

Pince conductrice pour tendons
Pinza conductora para tendones
Pinza conduttrice per tendini



1:2

CAROLL

110 mm - 4¼"

tk 38723-11

Sehnenfaßzange
Tendon grasping forceps

Pince pour saisir les tendons
Pinza para coger tendones
Pinza per afferrare tendini

Hohlmeißelzangen
Bone rongeurs

Pinces gouges
Pinzas gubias
Pinze sgorbie

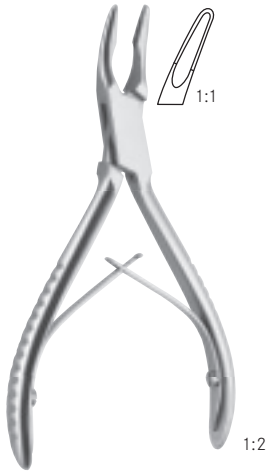

MINI-FRIEDMAN
120 mm - 4¾" **tk 24605-12**



FRIEDMAN
140 mm - 5½" **tk 24605-14**

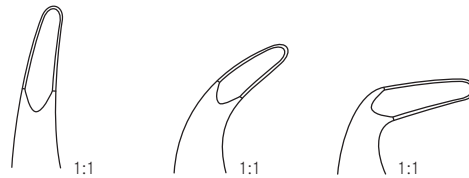

BLUMENTHAL

	Fig. 1	Fig. 2	Fig. 3
155 mm - 6"	tk 24606-01	tk 24606-02	tk 24606-03

Hohlmeißelzangen
Bone rongeurs

Pinces gouges
Pinzas gubias
Pinze sgorbie



1:2



1:1



1:1

BÖHLER

150 mm - 6"	tk 24613-00	tk 24613-02
-------------	--------------------	--------------------



1:2



1:1

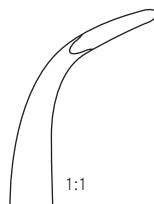

1:1

STELLBRINK

175 mm - 7"	tk 24614-01	tk 24614-02
-------------	--------------------	--------------------

leicht gebogen
slightly curved

stark gebogen
strongly curved

légèrement courbe
ligeramente curvada
legermente curvata

très courbe
fuertemente curvada
fortemente curvata

Hohlmeißelzangen
Bone rongeurs

Pinces gouges
Pinzas gubias
Pinze sgorbie



**ZAUFAL-
JANSEN**

180 mm - 7"

tk 24614-18

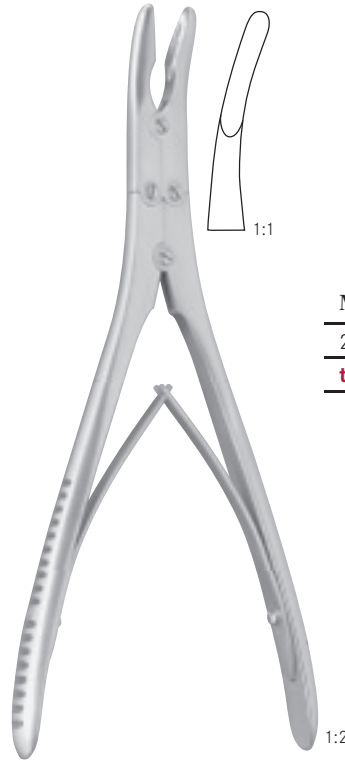

MARQUARDT

200 mm - 8"

tk 24614-20



BEYER

180 mm - 7"

tk 24615-18



RUSKIN

180 mm - 7"

tk 24616-05

tk 24616-04

Knochensplitterzangen
Bone cutting forceps

Pinces coupantes à os
Pinzas cortantes para huesos
Cesoie per ossa

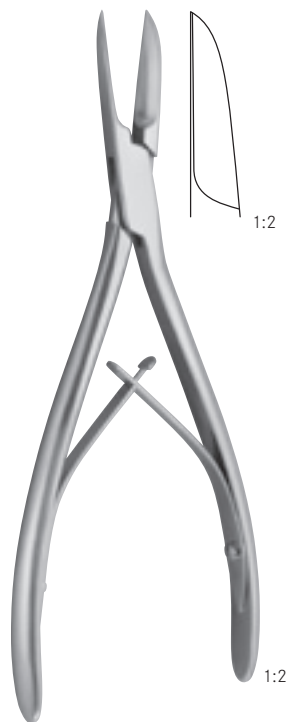

**COTTLE-
KAZANJIAN**

190 mm - 7½"

tk 24649-19



BÖHLER

150 mm - 6"

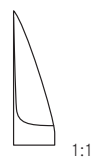

1:1

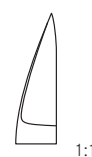

1:1

tk 24654-15

tk 24655-15



RUSKIN-LISTON

185 mm - 7¼"

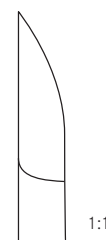

1:1



1:1

tk 24660-18

tk 24661-18

Tränenkanal-Dilatatoren
Lacrimal dilators

Dilatateurs pour le canal lacrymal
Dilatadores para el canal lacrimal
Dilatatori lacrimali

Tränenkanal-Dilatator

Lacrimal dilators

Dilatateurs pour le canal lacrymal

Dilatadores para el canal lacrimal

Dilatatori lacrimali



BOWMAN

Fig. 000 / 00	Fig. 00 / 0	Fig. 0 / 1	Fig. 1 / 2	Fig. 2 / 3
0.4 / 0.6 mm Ø	0.7 / 0.8 mm Ø	0.8 / 0.9 mm Ø	0.9 / 1.1 mm Ø	1.1 / 1.3 mm Ø
tk40099-00	tk40100-00	tk40100-01	tk40100-12	tk40100-23
Fig. 3 / 4	Fig. 4 / 5	Fig. 5 / 6	Fig. 6 / 7	Fig. 7 / 8
1.3 / 1.4 mm Ø	1.4 / 1.5 mm Ø	1.5 / 1.6 mm Ø	1.6 / 1.8 mm Ø	1.8 / 1.9 mm Ø
tk40100-34	tk40100-45	tk40100-56	tk40100-67	tk40100-78

zylindrisch

cylindrical

cylindriques

cilíndrico

cilindrico



WILLIAMS

Fig. 000 / 00	Fig. 00 / 0	Fig. 0 / 1	Fig. 1 / 2	Fig. 2 / 3
0.4 / 0.6 mm Ø	0.7 / 0.8 mm Ø	0.8 / 0.9 mm Ø	0.9 / 1.1 mm Ø	1.1 / 1.3 mm Ø
tk40101-00	tk40102-00	tk40102-01	tk40102-12	tk40102-23
Fig. 3 / 4	Fig. 4 / 5	Fig. 5 / 6	Fig. 6 / 7	Fig. 7 / 8
1.3 / 1.4 mm Ø	1.4 / 1.5 mm Ø	1.5 / 1.6 mm Ø	1.6 / 1.8 mm Ø	1.8 / 1.9 mm Ø
tk40102-34	tk40102-45	tk40102-56	tk40102-67	tk40102-78

geknöpft

probe

boutonnés

botonado

botonuti

Tränenkanal-Dilatatoren
Lacrimal dilators

Dilatateurs pour le canal lacrymal
Dilatadores para el canal lacrimal
Dilatatori lacrimali

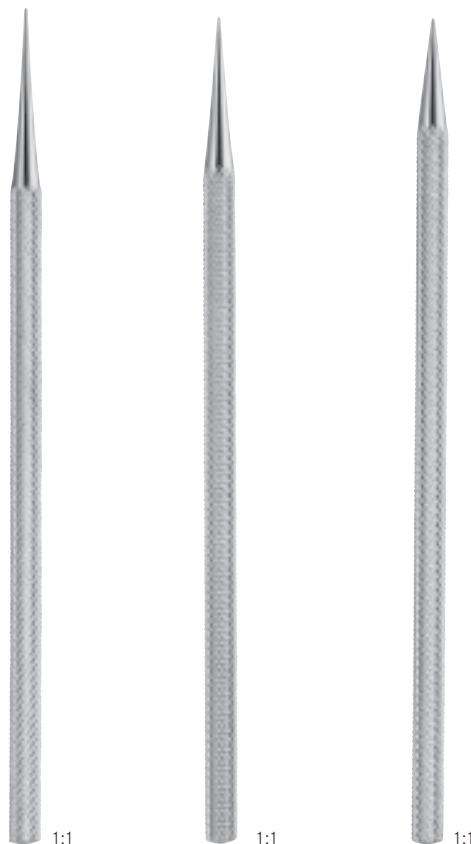

115 mm - 4½"	tk 18110-11	tk 18112-11
130 mm - 5"	tk 18110-13	tk 18112-13
145 mm - 5¾"	tk 18110-14	tk 18112-14
160 mm - 6¼"	tk 18110-16	tk 18112-16
180 mm - 7"	tk 18110-18	tk 18112-18
200 mm - 8"	tk 18110-20	tk 18112-20

WILDER

tk 40105-00	tk 40106-00	tk 40107-00
--------------------	--------------------	--------------------

Tränenkanal-Dilatatoren
Lacrimal dilators

Dilatateurs pour le canal lacrymal
Dilatadores para el canal lacrimal
Dilatatori lacrimali

Knorpelquetscher
Bone crusher

Broyeurs pour os
Prensas para huesos
Trittatori osseo



1:2



1:2

COTTLE

tk 51648-00

Quetscher mit Klammer
bone crusher with clamp

broyeur avec pince
prensa para huesos
sciaccia cartilagine



1:2

tk 51755-00

Knorpelhalter
cartilage holding forceps

pince à saisir des cartilages
pinza para tener cartilagos
pinza fissa cartilagine



COTTLE

tk 51649-00

Knochenmühle
bone mill

moulin d'os
molino de huesos
mulino per ossa

Instrumenten-Kassetten aus Edelstahl
Instrument trays made of stainless steel

Contenaires d'instruments en acier inox
Cajas en acero inox para instrumental
Scatole per sterilizzazione di acciaio inossidabile

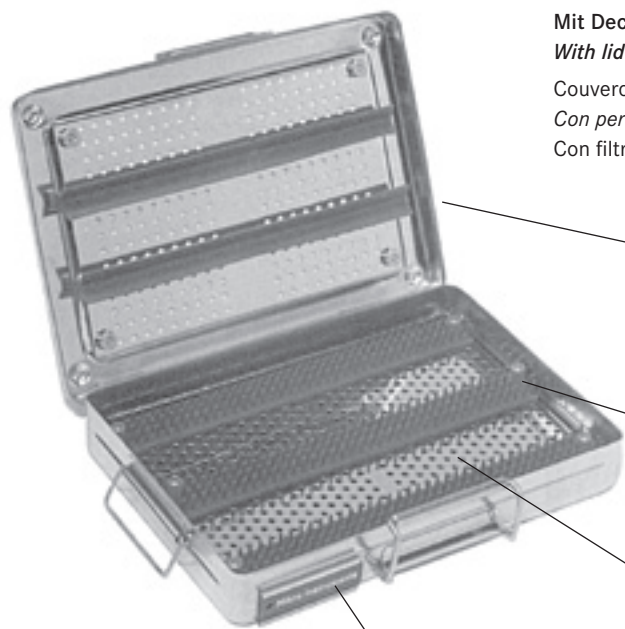

Mit Deckel- und Bodenlochung mit Textil-Langzeitfiltern für Dampfsterilisation
With lid and bottom perforation with textil "Longterm" filters for steam sterilisation
Couvercle et boîtier perforé avec filtre en textile pour stérilisation à vapeur
Con perforación en tapa y fondo, con filtros en tejido para esterilización a vapor
Con filtri tessili, per la sterilizzazione a vapore

Silikon-Andrückleisten zum Fixieren der Instrumente
Silicone protective strips for fixation of instruments
Tapis en silicone pour fixer les instruments
Tiras de silicon para fijar los instrumentos
Righe di silicone per fissare gli strumenti

Silikon-Noppenstreifen zur schonenden Auflage der Instrumente
Silicon strips for a soft and protective storage of the instruments
Tapis en silicone pour la protection des instruments
Mata de silicon para proteger los instrumentos
Stuoie di silicone per proteggere gli strumenti

1 herausnehmbare Siebplatte
1 removable tray insert
1 tableau pour sortir
1 placa para sacar
1 cestello

Kennzeichnungsschilder nach Wahl (Farbe und Text)
Marking plate for selection: colour and description
Plaque d'identification (texte et couleur selon demande)
Placas de identificación a opción (color y texto)
Placche d'identificazione (colore a scelta)

280 x 195 x 55 mm	265 x 255 x 55 mm	380 x 260 x 55 mm	200 x 140 x 55 mm	470 x 250 x 55 mm
tk 85100-01	tk 85101-01	tk 85102-01	tk 85103-01	tk 85104-01

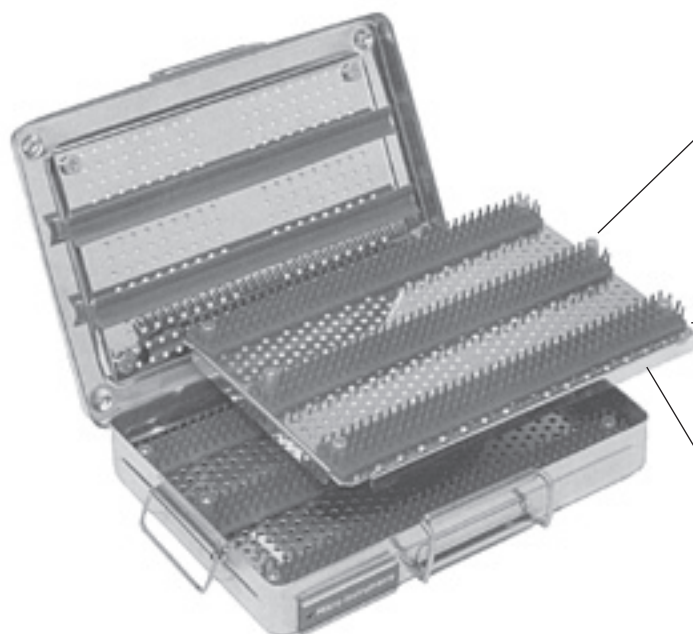

wärmeisolierende Halteknöpfe zum Herausheben
heatisolated handles
pins isolés pour sortir des tableaux
Pernos aislados para sacar las placas
maniglia a forma di botone

2 herausnehmbare Siebplatten
2 removable tray inserts
2 tableaux detachables
2 placas para sacar
2 cestelli

Silikon-Andrückleisten an der Unterseite des Siebes
Silicon protective strips at the lower side of the tray
Tapis de silicone à la partie inférieure des tableaux
Tiras de silicon a bajo de las placas
Righe di silicone

280 x 195 x 65 mm	265 x 255 x 65 mm	380 x 260 x 65 mm	200 x 140 x 65 mm	470 x 250 x 65 mm
tk 85100-03	tk 85101-03	tk 85102-03	tk 85103-03	tk 85104-03

Grundinstrumentarium für die plastische Chirurgie
Basic set for plastic surgery

 Set de base pour la chirurgie plastique
Juego de base para la cirugía plástica
 Set di base per la chirurgia plastica

tk56500-00











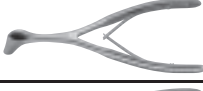
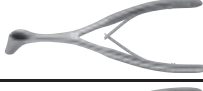
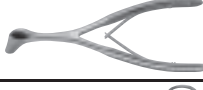

Dieser Satz beinhaltet folgende Instrumente:

This set contents the following instruments:

Ce jeu contient des instruments suivants:

Este juego contiene los instrumentos siguientes:

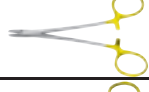
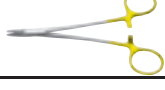
Questo set contiene seguenti strumenti:

FARABEUF [pos 01]	<i>Retractor set</i>		120 mm	tk 17311-12	
DESMARRES [pos 02]	<i>Retractor</i>		160 mm	tk 17038-10	→ S 90
JOSEPH [pos 03]	<i>Retractor</i>		150 mm	tk 16900-15	→ S 85
JOSEPH [pos 04]	<i>Retractor</i>		160 mm	tk 16910-02	→ S 85
[pos 05]	<i>Retractor, 4 teeth, sharp, flexible</i>		160 mm	tk 17024-16	→ S 90
HARTMANN - HALLE [pos 06]	<i>Nasal specula, fig. 1</i>		150 mm	tk 50813-01	→ S 140
HARTMANN - HALLE [pos 07]	<i>Nasal specula, fig. 2</i>		150 mm	tk 50813-02	→ S 140
HARTMANN - HALLE [pos 08]	<i>Nasal specula, fig. 3</i>		150 mm	tk 50813-03	→ S 140
FOERSTER [pos 09]	<i>Sponge holding forceps, curved</i>		180 mm	tk 15185-18	→ S 83
JOSEPH [pos 10]	<i>Periost elevator, 4 mm</i>		160 mm	tk 51613-16	→ S 132
FREER [pos 11]	<i>Elevators, sharp / blunt</i>		180 mm	tk 51627-18	→ S 133
CASTROVIEJO - JACOBSON [pos 12]	<i>Needle holder, straight</i>		180 mm	tk 20710-18	→ S 114
BARRAQUER [pos 13]	<i>Needle holder, curved</i>		145 mm	tk 20201-14	→ S 114
WEBSTER [pos 14]	<i>Needle holder, smooth, TC</i>		130 mm	tk 20509-13	→ S 106
DERF [pos 15]	<i>Needle holder, TC</i>		125 mm	tk 20508-12	→ S 105
MAYO - HEGAR [pos 16]	<i>Needle holder, TC</i>		180 mm	tk 20512-18	→ S 108
[pos 17]	<i>Standard dressing forceps</i>		145 mm	tk 10000-14	

Grundinstrumentarium für die plastische Chirurgie
Basic set for plastic surgery

Set de base pour la chirurgie plastique
Juego de base para la cirugía plástica
 Set di base per la chirurgia plastica

ADSON [pos 18]	<i>Dressing forceps</i>		120 mm	tk 10500-12	→ S 54
TAYLOR [pos 19]	<i>Dressing forceps, bayonet</i>		175 mm	tk 10313-17	→ S 59
ADSON [pos 20]	<i>Tissue forceps, 1 x 2 teeth</i>		120 mm	tk 11200-12	→ S 55
ADSON - BROWN [pos 21]	<i>Tissue forceps</i>		120 mm	tk 11210-12	→ S 54
GRAEFE [pos 22]	<i>Forceps, fine pattern, straight, 1 x 2 teeth</i>		105 mm	tk 11730-10	→ S 56
MAYO [pos 23]	<i>Scissors, straight</i>		150 mm	tk 8272-15	→ S 24
SHEA [pos 24]	<i>Scissors, curved, pointed</i>		120 mm	tk 9209-12	→ S 45
METZENBAUM - NELSON [pos 25]	<i>Scissors, straight, fig. 1</i>		180 mm	tk 8347-18	→ S 28
SHEA [pos 26]	<i>Scissors, straight, pointed</i>		120 mm	tk 9208-12	→ S 45
METZENBAUM - FINO [pos 27]	<i>Scissors, curved, fig. 1</i>		180 mm	tk 8371-18	→ S 30
KNAPP [pos 28]	<i>Fine scissors, blunt, curved</i>		105 mm	tk 8689-10	→ S 32
CRILE [pos 29]	<i>Haemostatic forceps, curved, 1 x 2 teeth</i>		140 mm	tk 12053-14	→ S 78
KOCHER [pos 30]	<i>Haemostatic forceps, curved, 1 x 2 teeth, delicate</i>		160 mm	tk 12079-16	→ S 80
CRILE [pos 31]	<i>Haemostatic forceps, curved</i>		140 mm	tk 12051-14	→ S 78
HALSTEAD - MOSQUITO [pos 32]	<i>Haemostatic forceps, curved</i>		125 mm	tk 12011-12	→ S 76
ALLIS [pos 33]	<i>Intestinal grasping forceps, 4 x 5 teeth</i>		150 mm	tk 28140-15	→ S 71
YANKAUER [pos 34]	<i>Suction tube</i>		270 mm	tk 6350-27	
[pos 35]	<i>Scalpel handle, no. 3</i>		??? mm	tk 7110-03	→ S 7
BACKHAUS [pos 36]	<i>Towel forceps</i>		110 mm	tk 12805-11	
BACKHAUS [pos 37]	<i>Towel forceps</i>		130 mm	tk 12805-13	

Nummernverzeichnis
Numerical index

Index numériques
Indice numerico
Indice dei numeri d'articolo

tk 4651-10 11	tk 8125-16-C..... 18	tk 8279-17 TC..... 24	tk 8343-30 28	tk 8354-28 29	tk 8381-20-A..... 17
tk 4651-15 11	tk 8125-16-D..... 18	tk 8279-23 TC..... 24	tk 8344-18 28	tk 8354-30 29	tk 8381-20-B..... 17
tk 4651-20 11	tk 8125-16-E..... 18	tk 8283-17-A..... 19	tk 8344-20 28	tk 8356-18 29	tk 8381-20-C..... 17
tk 4651-30 11	tk 8134-11..... 47	tk 8283-17-B..... 19	tk 8344-23 28	tk 8356-20 29	tk 8381-20-E..... 17
tk 4651-50 11	tk 8134-11 SU 47	tk 8283-17-C..... 19	tk 8344-25 28	tk 8356-23 29	tk 8381-20 SU 30
tk 4664-01 11	tk 8134-11 SUB 47	tk 8283-17-D..... 19	tk 8344-28 28	tk 8356-25 29	tk 8381-20 SUB 30
tk 4664-02 11	tk 8135-11 47	tk 8283-17-E..... 19	tk 8344-30 28	tk 8356-28 29	tk 8381-23 30
tk 4664-03 11	tk 8135-11 SU 47	tk 8323-11 28	tk 8345-18 28	tk 8356-30 29	tk 8381-23 SU 30
tk 4664-04 11	tk 8135-11 SUB 47	tk 8323-14 28	tk 8345-20 28	tk 8357-18 TC..... 29	tk 8381-23 SUB 30
tk 4664-05 11	tk 8138-16 TC..... 26	tk 8323-14-A..... 16	tk 8345-23 28	tk 8357-20 TC..... 29	tk 8392-14 44
tk 4664-06 11	tk 8139-16 TC..... 26	tk 8323-14-B..... 16	tk 8345-25 28	tk 8357-23 TC..... 29	tk 8392-14 SU 44
tk 4664-07 11	tk 8154-14..... 41	tk 8323-14-C..... 16	tk 8345-28 28	tk 8357-25 TC..... 29	tk 8392-14 SUB 44
tk 4664-08 11	tk 8154-18..... 41	tk 8323-14-E..... 16	tk 8345-30 28	tk 8357-28 TC..... 29	tk 8394-19 44
tk 4664-09 11	tk 8155-14..... 41	tk 8323-14 SU 28	tk 8347-18 TC..... 28	tk 8357-30 TC..... 29	tk 8462-16 26
tk 4664-10 11	tk 8155-18..... 41	tk 8323-14 SUB 28	tk 8347-20 TC..... 28	tk 8358-18 TC..... 29	tk 8462-18 26
tk 4664-11 11	tk 8188-11..... 46	tk 8324-14 28	tk 8347-23 TC..... 28	tk 8358-20 TC..... 29	tk 8463-13-A..... 21
tk 7100-04 7	tk 8188-11 SU 46	tk 8325-14 28	tk 8347-25 TC..... 28	tk 8358-23 TC..... 29	tk 8463-13-B..... 21
tk 7110-03 7	tk 8188-11 SUB 46	tk 8327-11 TC..... 28	tk 8347-28 TC..... 28	tk 8359-18 TC..... 29	tk 8463-16 26
tk 7110-07 7	tk 8188-14..... 46	tk 8327-14 TC..... 28	tk 8347-30 TC..... 28	tk 8359-20 TC..... 29	tk 8463-16-A..... 20
tk 7110-71 7	tk 8188-14 SU 46	tk 8328-14 TC..... 28	tk 8348-18 TC..... 28	tk 8359-23 TC..... 29	tk 8463-16-B..... 20
tk 7113-03 7	tk 8188-14 SUB 46	tk 8329-14 TC..... 28	tk 8348-20 TC..... 28	tk 8363-14 TC..... 30	tk 8463-16-C..... 20
tk 7115-03 7	tk 8189-11 46	tk 8333-11 29	tk 8348-23 TC..... 28	tk 8365-14 TC..... 30	tk 8463-16-D..... 20
tk 7116-03 7	tk 8189-11 SU 46	tk 8333-11-A..... 17	tk 8349-18 TC..... 28	tk 8366-14 TC..... 30	tk 8463-16-E..... 20
tk 7120-13 6	tk 8189-11 SUB 46	tk 8333-11-B..... 17	tk 8349-20 TC..... 28	tk 8367-14 TC..... 30	tk 8463-18 26
tk 7121-03 6	tk 8189-14..... 46	tk 8333-11-C..... 17	tk 8349-23 TC..... 28	tk 8370-18 TC..... 30	tk 8523-12 25
tk 7121-04 6	tk 8189-14 SU 46	tk 8333-11-D..... 17	tk 8352-18 33	tk 8370-20 TC..... 30	tk 8524-12 25
tk 7121-07 6	tk 8189-14 SUB 46	tk 8333-11-E..... 17	tk 8352-18 SU 33	tk 8370-23 TC..... 30	tk 8525-12 25
tk 7121-09 6	tk 8193-14 TC..... 27	tk 8333-14..... 29	tk 8352-18 SUB 33	tk 8371-18 TC..... 30	tk 8533-12 25
tk 7210-10T 8	tk 8197-14 SU TC 27	tk 8333-14-A..... 16	tk 8353-15 29	tk 8371-20 TC..... 30	tk 8534-12 25
tk 7210-11T 8	tk 8198-14 27	tk 8333-14-B..... 16	tk 8353-15-A..... 16	tk 8371-23 TC..... 30	tk 8535-12 25
tk 7210-12DT 8	tk 8198-14 SU 27	tk 8333-14-C..... 16	tk 8353-15-B..... 16	tk 8372-14 30	tk 8572-14 27
tk 7210-12T 8	tk 8198-14 SUB 27	tk 8333-14-E..... 16	tk 8353-18 29	tk 8372-14 SU 30	tk 8573-14 27
tk 7210-15CT 8	tk 8272-14 24	tk 8333-14 SU 29	tk 8353-18-A..... 16	tk 8372-14 SUB 30	tk 8582-16 33
tk 7210-15T 8	tk 8272-14 SU 24	tk 8333-14 SUB 29	tk 8353-18-B..... 16	tk 8373-14 30	tk 8587-16 33
tk 7210-18T 8	tk 8272-14 SUB 24	tk 8334-14 29	tk 8353-18-C..... 16	tk 8373-14-A..... 17	tk 8592-12 33
tk 7210-20T 8	tk 8272-15 24	tk 8335-14 29	tk 8353-18-E..... 16	tk 8373-14-B..... 17	tk 8597-12 33
tk 7210-21T 8	tk 8272-15 SU 24	tk 8337-11 TC..... 29	tk 8353-18 SU 29	tk 8373-14-C..... 17	tk 8602-16 36
tk 7210-22T 8	tk 8272-15 SUB 24	tk 8337-14 TC..... 29	tk 8353-18 SUB 29	tk 8373-14-E..... 17	tk 8602-16 SU 36
tk 7210-23T 8	tk 8272-17 24	tk 8338-14 TC..... 29	tk 8353-20 29	tk 8373-14 SU 30	tk 8602-16 SUB 36
tk 7210-24T 8	tk 8272-17 SU 24	tk 8339-14 TC..... 29	tk 8353-20-A..... 16	tk 8373-14 SUB 30	tk 8602-18 36
tk 7890-20 9	tk 8272-17 SUB 24	tk 8343-15 28	tk 8353-20-B..... 16	tk 8374-14 30	tk 8602-18 SU 36
tk 7900-00 9	tk 8272-23 24	tk 8343-18 28	tk 8353-20-C..... 16	tk 8375-14 30	tk 8602-18 SUB 36
tk 7901-00 9	tk 8272-23 SU 24	tk 8343-18-A..... 16	tk 8353-20-E..... 16	tk 8380-18 30	tk 8603-14-A..... 19
tk 7902-00 9	tk 8272-23 SUB 24	tk 8343-18-B..... 16	tk 8353-20 SU 29	tk 8380-18 SU 30	tk 8603-16 36
tk 7905-00 10	tk 8273-14 24	tk 8343-18-C..... 16	tk 8353-20 SUB 29	tk 8380-18 SUB 30	tk 8603-16-A..... 19
tk 7907-00 10	tk 8273-14 SU 24	tk 8343-18-E..... 16	tk 8353-23 29	tk 8380-20 30	tk 8603-16-E..... 19
tk 7908-00 10	tk 8273-14 SUB 24	tk 8343-18 SU 28	tk 8353-23-A..... 16	tk 8380-20 SU 30	tk 8603-16 SU 36
tk 8122-16 26	tk 8273-15 24	tk 8343-18 SUB 28	tk 8353-23-B..... 16	tk 8380-20 SUB 30	tk 8603-16 SUB 36
tk 8122-16 SU 26	tk 8273-15 SU 24	tk 8343-20 28	tk 8353-23-C..... 16	tk 8380-23 30	tk 8603-18 36
tk 8122-16 SUB 26	tk 8273-15 SUB 24	tk 8343-20-A..... 16	tk 8353-23-E..... 16	tk 8380-23 SU 30	tk 8603-18 SU 36
tk 8122-21 26	tk 8273-17 24	tk 8343-20-B..... 16	tk 8353-23 SU 29	tk 8380-23 SUB 30	tk 8603-18 SUB 36
tk 8123-16 26	tk 8273-17 SU 24	tk 8343-20-C..... 16	tk 8353-23 SUB 29	tk 8381-18 30	tk 8632-11 31
tk 8123-16-A..... 18	tk 8273-17 SUB 24	tk 8343-20-E..... 16	tk 8353-25 29	tk 8381-18-A..... 17	tk 8633-11 31
tk 8123-16-B..... 18	tk 8273-23 24	tk 8343-20 SU 28	tk 8353-25-E..... 16	tk 8381-18-B..... 17	tk 8636-11 TC..... 31
tk 8123-16-C..... 18	tk 8273-23 SU 24	tk 8343-20 SUB 28	tk 8353-28 29	tk 8381-18-C..... 17	tk 8637-11 TC..... 31
tk 8123-16-D..... 18	tk 8273-23 SUB 24	tk 8343-23 28	tk 8353-30 29	tk 8381-18-D..... 17	tk 8642-09 31
tk 8123-16-E..... 18	tk 8278-14 TC..... 24	tk 8343-23 SU 28	tk 8354-18 29	tk 8381-18-E..... 17	tk 8643-09 31
tk 8123-16 SU 26	tk 8278-17 TC..... 24	tk 8343-23 SUB 28	tk 8354-20 29	tk 8381-18 SU 30	tk 8652-09 31
tk 8123-16 SUB 26	tk 8278-23 TC..... 24	tk 8343-25 28	tk 8354-23 29	tk 8381-18 SUB 30	tk 8652-10 31
tk 8123-21 26	tk 8279-14 TC..... 24	tk 8343-28 28	tk 8354-25 29	tk 8381-20 30	tk 8652-10 SU 31

Nummernverzeichnis
Numerical index
Index numériques
Indice numerico
Indice dei numeri d'articolo

tk 8652-10 SUB31	tk 9171-23 TC38	tk 9191-18 SUB42	tk 9463-10 SU35	tk 11150-2158	tk 12011-14-P72
tk 8652-1131	tk 9172-18 TC40	tk 9192-17 TC42	tk 9463-10 SUB35	tk 11150-2558	tk 12012-1276
tk 8653-0931	tk 9172-19 SU TC38	tk 9192-20 TC42	tk 9463-1135	tk 11151-1858	tk 12012-12-P72
tk 8653-1031	tk 9173-18 TC40	tk 9193-14 TC27	tk 9463-11 SU35	tk 11151-2158	tk 12012-1476
tk 8653-10 SU31	tk 9173-19 SU TC38	tk 9193-17 TC42	tk 9463-11 SUB35	tk 11151-2558	tk 12012-14-P72
tk 8653-10 SUB31	tk 9174-14 SU39	tk 9193-20 TC42	tk 9482-1132	tk 11200-1255	tk 12013-1276
tk 8653-1131	tk 9174-14 SUB39	tk 9196-14 TC43	tk 9482-11 SU32	tk 11200-1555	tk 12013-12-P72
tk 8688-1032	tk 9174-14 TC39	tk 9197-14 SU TC27	tk 9483-1132	tk 11202-1255	tk 12013-1476
tk 8689-1032	tk 9174-18 SU39	tk 9198-1146	tk 9483-11 SU32	tk 11202-1555	tk 12013-14-P72
tk 8692-1437	tk 9174-18 SUB39	tk 9198-11 SU46	tk 9483-11 SUB32	tk 11204-1255	tk 12020-1076
tk 8693-1437	tk 9174-18 TC39	tk 9198-11 SUB46	tk 9483-11 SUB32	tk 11206-1255	tk 12020-10-P72
tk 8693-14-A20	tk 9175-14 SU39	tk 9198-1427	tk 9922-1341	tk 11206-12B55	tk 12020-1276
tk 8693-14-B20	tk 9175-14 SUB39	tk 9198-14 SU27	tk 9922-13 SU41	tk 11206-1355	tk 12020-12-P72
tk 8694-0932	tk 9175-14 TC39	tk 9198-14 SUB27	tk 9922-13 SUB41	tk 11206-1555	tk 12020-1477
tk 8697-1236	tk 9175-18 SU39	tk 9199-1146	tk 9923-1341	tk 11210-1254	tk 12021-1076
tk 8697-12 SU36	tk 9175-18 SUB39	tk 9199-11 SU46	tk 9923-13 SU41	tk 11212-1254	tk 12021-10-P72
tk 8697-12 SUB36	tk 9175-18 TC39	tk 9199-11 SUB46	tk 9923-13 SUB41	tk 11250-1553	tk 12021-1276
tk 8697-1536	tk 9176-23 SU39	tk 9199-1342	tk 9924-13 SU TC41	tk 11300-1252	tk 12021-12-P72
tk 8697-15 SU36	tk 9176-23 SUB39	tk 9200-11 SU TC46	tk 9925-13 SU TC41	tk 11300-1552	tk 12021-1477
tk 8697-15 SUB36	tk 9176-23 TC39	tk 9200-11 TC46	tk 10300-1252	tk 11635-1057	tk 12022-1076
tk 8697-18 SU36	tk 9177-23 SU39	tk 9201-11 SU TC46	tk 10300-1552	tk 11640-15 TC53	tk 12022-10-P72
tk 8697-18 SUB36	tk 9177-23 SUB39	tk 9201-11 TC46	tk 10310-1759	tk 11690-14 TC53	tk 12022-1276
tk 8697-20 SU36	tk 9177-23 TC39	tk 9203-1034	tk 10312-1759	tk 11690-16 TC53	tk 12022-12-P72
tk 8697-20 SUB36	tk 9178-14 SU TC39	tk 9205-1844	tk 10313-1759	tk 11690-18 TC53	tk 12023-1076
tk 8698-12 TC36	tk 9178-18 SU TC39	tk 9206-1134	tk 10324-1859	tk 11690-20 TC53	tk 12023-10-P72
tk 8698-15 TC36	tk 9178-23 SU TC39	tk 9207-1134	tk 10325-1859	tk 11690-25 TC53	tk 12023-1276
tk 8702-20 TC37	tk 9179-1147	tk 9208-1245	tk 10326-1959	tk 11690-30 TC53	tk 12023-12-P72
tk 8702-23 TC37	tk 9179-14 SU TC39	tk 9208-12 SU45	tk 10327-1560	tk 11700-1056	tk 12030-1477
tk 8703-20 TC37	tk 9179-18 SU TC39	tk 9208-12 SUB45	tk 10327-1860	tk 11701-1056	tk 12031-1277
tk 8703-23 TC37	tk 9179-23 SU TC39	tk 9208-1643	tk 10328-1860	tk 11703-1056	tk 12032-1477
tk 8704-18 SU37	tk 9180-1147	tk 9209-1245	tk 10328-2060	tk 11730-1056	tk 12034-1579
tk 8704-18 SUB37	tk 9182-1742	tk 9209-12 SU45	tk 10400-1752	tk 11731-1056	tk 12035-1579
tk 8704-23 SU37	tk 9182-17 SU42	tk 9209-12 SUB45	tk 10401-1752	tk 11733-1056	tk 12040-1479
tk 8704-23 SUB37	tk 9182-17 SUB42	tk 9209-1643	tk 10402-17 TC52	tk 11960-1261	tk 12040-14-P73
tk 8705-18 SU37	tk 9182-18 SU40	tk 9210-16 TC43	tk 10500-1254	tk 11960-1461	tk 12040-1679
tk 8705-18 SUB37	tk 9182-18 SUB40	tk 9211-0945	tk 10500-1554	tk 11960-1661	tk 12040-16-P73
tk 8705-23 SU37	tk 9182-2042	tk 9212-0945	tk 10502-12 TC54	tk 11960-2061	tk 12041-1479
tk 8705-23 SUB37	tk 9182-20 SU42	tk 9432-1131	tk 10502-15 TC54	tk 11960-2461	tk 12041-14-P73
tk 8706-15 SU40	tk 9182-20 SUB42	tk 9434-1131	tk 10503-1254	tk 11964-1461	tk 12041-1679
tk 8706-15 SUB40	tk 9183-1742	tk 9434-11-B21	tk 10503-1554	tk 11964-1661	tk 12041-16-P73
tk 8707-15 SU40	tk 9183-17 SU42	tk 9434-11-C21	tk 10504-12 TC55	tk 11964-2061	tk 12050-1478
tk 8707-15 SUB40	tk 9183-17 SUB42	tk 9452-1035	tk 10504-15 TC55	tk 11964-2461	tk 12050-14-P73
tk 8832-1844	tk 9183-18 SU40	tk 9452-10 SU35	tk 10506-12 TC55	tk 11964-3061	tk 12050-1678
tk 9134-11 SU TC47	tk 9183-18 SUB40	tk 9452-10 SUB35	tk 10506-15 TC55	tk 11968-15 TC62	tk 12050-16-P73
tk 9134-11 TC47	tk 9183-18 SU TC40	tk 9452-1135	tk 10508-12 TC54	tk 11968-19 TC62	tk 12051-1478
tk 9135-11 SU TC47	tk 9183-2042	tk 9452-11 SU35	tk 10550-1553	tk 11968-24 TC62	tk 12051-14-P73
tk 9135-11 TC47	tk 9183-20 SU42	tk 9452-11 SUB35	tk 10604-2057	tk 11969-15 TC62	tk 12051-1678
tk 9163-20 SU39	tk 9183-20 SUB42	tk 9453-1035	tk 10608-1553	tk 11969-19 TC62	tk 12051-16-P73
tk 9163-20 SUB39	tk 9185-23 SU38	tk 9453-10 SU35	tk 10608-2353	tk 11969-24 TC62	tk 12052-1478
tk 9164-20 TC39	tk 9186-23 SU38	tk 9453-10 SUB35	tk 10616-1557	tk 12000-1076	tk 12053-1478
tk 9165-20 SU TC39	tk 9188-11 SU TC46	tk 9453-1135	tk 10616-2057	tk 12000-10-P72	tk 12054-1678
tk 9167-1938	tk 9188-11 TC46	tk 9453-11 SU35	tk 10616-2557	tk 12001-1076	tk 12055-1678
tk 9168-1938	tk 9188-14 SU TC46	tk 9453-11 SUB35	tk 11086-1557	tk 12001-10-P72	tk 12058-1378
tk 9168-19 SU38	tk 9188-14 TC46	tk 9454-1034	tk 11086-2057	tk 12010-1276	tk 12058-13-P74
tk 9168-19 SUB38	tk 9189-11 SU TC46	tk 9455-1034	tk 11087-1557	tk 12010-12-P72	tk 12058-1478
tk 9169-19 SU38	tk 9189-11 TC46	tk 9456-1034	tk 11087-2057	tk 12010-1476	tk 12058-14-P74
tk 9169-19 SUB38	tk 9189-14 SU TC46	tk 9457-1034	tk 11087-2557	tk 12010-14-P72	tk 12058-1678
tk 9170-19 TC38	tk 9189-14 TC46	tk 9462-1035	tk 11100-2058	tk 12011-1276	tk 12058-16-P74
tk 9170-23 TC38	tk 9191-1842	tk 9462-1135	tk 11101-2058	tk 12011-12-P72	tk 12059-1378
tk 9171-19 TC38	tk 9191-18 SU42	tk 9463-1035	tk 11150-1858	tk 12011-1476	tk 12059-13-P74

Nummernverzeichnis
Numerical index
Index numériques
Indice numerico
Indice dei numeri d'articolo

tk 12059-14.....78	tk 16905-02.....85	tk 17090-18.....95	tk 17219-06.....92	tk 20012-16.....108	tk 20522-26 TC.....111
tk 12059-14-P.....74	tk 16905-03.....85	tk 17091-18.....95	tk 17219-07.....92	tk 20012-18.....108	tk 20524-18 TC.....110
tk 12059-16.....78	tk 16906-19.....86	tk 17092-18.....95	tk 17219-08.....92	tk 20012-20.....108	tk 20524-20 TC.....110
tk 12059-16-P.....74	tk 16906-59.....86	tk 17093-18.....95	tk 17219-09.....92	tk 20012-24.....108	tk 20524-26 TC.....110
tk 12062-14-P.....75	tk 16907-10.....87	tk 17094-18.....95	tk 17219-10.....92	tk 20012-26.....108	tk 20525-14 TC.....111
tk 12062-16-P.....75	tk 16907-12.....87	tk 17095-18.....95	tk 17330-07.....95	tk 20012-30.....108	tk 20525-18 TC.....111
tk 12062-18-P.....75	tk 16908-12.....86	tk 17114-01.....100	tk 17330-10.....95	tk 20035-14.....109	tk 20525-20 TC.....111
tk 12063-14-P.....75	tk 16910-02.....85	tk 17114-05.....100	tk 17330-17.....95	tk 20035-16.....109	tk 20525-23 TC.....111
tk 12063-16-P.....75	tk 16910-05.....85	tk 17114-06.....100	tk 17330-20.....95	tk 20036-12.....107	tk 20533-13 TC.....110
tk 12063-18-P.....75	tk 16910-07.....85	tk 17114-07.....100	tk 17331-07.....95	tk 20036-14.....107	tk 20535-14 TC.....109
tk 12078-13.....80	tk 16910-10.....85	tk 17114-09.....100	tk 17331-10.....95	tk 20036-17.....107	tk 20535-16 TC.....109
tk 12078-13-P.....74	tk 16912-20.....88	tk 17144-15.....98	tk 17336-10.....95	tk 20036-19.....107	tk 20536-12 TC.....107
tk 12078-14.....80	tk 16914-16.....88	tk 17145-18.....98	tk 17337-10.....95	tk 20106-14.....106	tk 20536-14 TC.....107
tk 12078-14-P.....74	tk 16915-01.....88	tk 17147-09.....96	tk 17400-10.....102	tk 20106-17.....106	tk 20536-17 TC.....107
tk 12078-16.....80	tk 16915-02.....88	tk 17147-10.....96	tk 17400-20.....102	tk 20106-20.....106	tk 20536-19 TC.....107
tk 12078-16-P.....74	tk 16915-03.....88	tk 17147-22.....97	tk 17401-10.....102	tk 20115-17.....113	tk 20540-13 TC.....113
tk 12079-13.....80	tk 16916-16.....88	tk 17147-38.....97	tk 17402-13.....102	tk 20115-20.....113	tk 20540-15 TC.....113
tk 12079-13-P.....74	tk 16917-15.....88	tk 17148-38.....96	tk 17402-16.....102	tk 20200-14.....114	tk 20540-18 TC.....113
tk 12079-14.....80	tk 16918-15.....88	tk 17156-01.....93	tk 17402-23.....102	tk 20201-14.....114	tk 20540-20 TC.....113
tk 12079-14-P.....74	tk 16920-16.....88	tk 17156-02.....93	tk 17402-26.....102	tk 20204-15.....114	tk 20540-23 TC.....113
tk 12079-16.....80	tk 16922-16.....88	tk 17156-03.....93	tk 17403-13.....102	tk 20204-18.....114	tk 20540-26 TC.....113
tk 12079-16-P.....74	tk 16930-15.....89	tk 17156-04.....93	tk 17403-16.....102	tk 20204-21.....114	tk 20541-13.....113
tk 12082-14-P.....75	tk 16933-17.....89	tk 17156-05.....93	tk 17404-20.....102	tk 20205-15.....114	tk 20541-15.....113
tk 12082-16-P.....75	tk 16935-17.....89	tk 17156-06.....93	tk 17404-26.....102	tk 20205-18.....114	tk 20541-18.....113
tk 12082-18-P.....75	tk 17001-16.....89	tk 17156-08.....93	tk 17404-30.....102	tk 20205-21.....114	tk 20541-20.....113
tk 12083-14-P.....75	tk 17002-16.....89	tk 17156-09.....93	tk 17404-36.....102	tk 20210-14.....114	tk 20541-23.....113
tk 12083-16-P.....75	tk 17003-16.....89	tk 17156-10.....93	tk 17405-20.....102	tk 20210-15.....114	tk 20542-13 TC.....113
tk 12083-18-P.....75	tk 17004-16.....89	tk 17156-11.....93	tk 17405-26.....102	tk 20210-18.....114	tk 20542-15 TC.....113
tk 12110-12.....76	tk 17011-16.....89	tk 17156-12.....93	tk 17408-01.....103	tk 20210-21.....114	tk 20542-18 TC.....113
tk 12111-12.....76	tk 17012-16.....89	tk 17156-13.....93	tk 17408-02.....103	tk 20211-14.....114	tk 20542-20 TC.....113
tk 12112-12.....76	tk 17013-16.....89	tk 17156-20.....93	tk 17409-13.....103	tk 20211-15.....114	tk 20542-23 TC.....113
tk 12113-12.....76	tk 17014-16.....89	tk 17156-21.....93	tk 17410-11.....103	tk 20211-18.....114	tk 20542-26 TC.....113
tk 12210-18.....80	tk 17021-16.....90	tk 17217-01.....91	tk 17410-13.....103	tk 20211-21.....114	tk 20546-12 TC.....109
tk 12211-18.....80	tk 17022-16.....90	tk 17217-02.....91	tk 17411-11.....103	tk 20304-13.....110	tk 20547-12 TC.....109
tk 12212-18.....80	tk 17024-16.....90	tk 17217-03.....91	tk 17411-13.....103	tk 20308-12.....105	tk 20548-12 TC.....109
tk 12213-18.....80	tk 17025-16.....90	tk 17217-04.....91	tk 17412-20.....103	tk 20502-15 TC.....105	tk 20549-12 TC.....109
tk 12220-14.....81	tk 17031-16.....90	tk 17217-05.....91	tk 17750-00.....87	tk 20502-18 TC.....105	tk 20560-16 TC.....113
tk 12220-18.....81	tk 17032-16.....90	tk 17217-06.....91	tk 17919-13.....86	tk 20502-20 TC.....105	tk 20560-18 TC.....113
tk 12221-14.....81	tk 17034-16.....90	tk 17217-07.....91	tk 18110-11.....159	tk 20503-14 TC.....106	tk 20560-20 TC.....113
tk 12221-18.....81	tk 17038-08.....90	tk 17217-08.....91	tk 18110-13.....159	tk 20504-15 TC.....106	tk 20560-23 TC.....113
tk 15130-18.....83	tk 17038-10.....90	tk 17217-09.....91	tk 18110-14.....159	tk 20508-12 TC.....105	tk 20560-25 TC.....113
tk 15130-25.....83	tk 17038-12.....90	tk 17217-10.....91	tk 18110-16.....159	tk 20509-13 TC.....106	tk 20570-13.....112
tk 15131-18.....83	tk 17038-14.....90	tk 17217-21.....91	tk 18110-18.....159	tk 20510-13 TC.....107	tk 20570-15.....112
tk 15131-25.....83	tk 17038-16.....90	tk 17217-22.....91	tk 18110-20.....159	tk 20511-13 TC.....107	tk 20570-17.....112
tk 15180-18.....83	tk 17038-18.....90	tk 17217-23.....91	tk 18112-11.....159	tk 20512-14 TC.....108	tk 20570-18.....112
tk 15180-25.....83	tk 17061-21.....94	tk 17217-24.....91	tk 18112-13.....159	tk 20512-16 TC.....108	tk 20570-20.....112
tk 15182-18.....83	tk 17062-21.....94	tk 17217-25.....91	tk 18112-14.....159	tk 20512-18 TC.....108	tk 20570-23.....112
tk 15182-20.....83	tk 17063-21.....94	tk 17217-26.....91	tk 18112-16.....159	tk 20512-20 TC.....108	tk 20615-17 TC.....113
tk 15182-25.....83	tk 17064-21.....94	tk 17217-27.....91	tk 18112-18.....159	tk 20512-24 TC.....108	tk 20615-20 TC.....113
tk 15183-18.....83	tk 17066-21.....94	tk 17217-28.....91	tk 18112-20.....159	tk 20512-26 TC.....108	tk 20704-15 TC.....114
tk 15183-25.....83	tk 17071-21.....94	tk 17217-29.....91	tk 20001-15.....105	tk 20512-30 TC.....108	tk 20704-18 TC.....114
tk 15185-18.....83	tk 17072-21.....94	tk 17217-30.....91	tk 20002-15.....105	tk 20515-16 TC.....110	tk 20704-21 TC.....114
tk 15185-20.....83	tk 17073-21.....94	tk 17218-01.....99	tk 20002-18.....105	tk 20515-18 TC.....110	tk 20705-15 TC.....114
tk 15185-25.....83	tk 17074-21.....94	tk 17218-02.....99	tk 20002-20.....105	tk 20515-20 TC.....110	tk 20705-18 TC.....114
tk 16900-15.....85	tk 17076-21.....94	tk 17218-03.....99	tk 20003-14.....106	tk 20516-14 TC.....106	tk 20705-21 TC.....114
tk 16901-22.....84	tk 17079-01.....94	tk 17219-01.....92	tk 20008-12.....105	tk 20516-17 TC.....106	tk 20710-14 TC.....114
tk 16902-16.....84	tk 17079-02.....94	tk 17219-02.....92	tk 20009-13.....106	tk 20516-20 TC.....106	tk 20710-15 TC.....114
tk 16903-30.....92	tk 17080-16.....94	tk 17219-03.....92	tk 20010-13.....107	tk 20522-18 TC.....111	tk 20710-18 TC.....114
tk 16904-17.....84	tk 17081-16.....94	tk 17219-04.....92	tk 20011-13.....107	tk 20522-20 TC.....111	tk 20710-21 TC.....114
tk 16905-01.....85	tk 17084-14.....95	tk 17219-05.....92	tk 20012-14.....108	tk 20522-23 TC.....111	tk 20711-14 TC.....114

Nummernverzeichnis
Numerical index

Index numériques
Indice numerico
Indice dei numeri d'articolo

tk 20711-15 TC.....	114	tk 24298-03.....	131	tk 25064-02.....	69	tk 25610-04.....	49	tk 25667-18.....	118	tk 28167-15.....	82
tk 20711-18 TC.....	114	tk 24519-19.....	137	tk 25064-03.....	69	tk 25610-15.....	50	tk 25668-18.....	118	tk 28180-20.....	82
tk 20711-21 TC.....	114	tk 24529-19.....	137	tk 25064-04.....	69	tk 25611-01.....	49	tk 25669-18.....	118	tk 28190-20.....	82
tk 24047-21.....	123	tk 24575-01.....	150	tk 25065-01.....	69	tk 25611-02.....	49	tk 25670-15.....	48	tk 28192-16.....	82
tk 24050-17.....	123	tk 24575-02.....	150	tk 25065-02.....	69	tk 25611-03.....	49	tk 25670-18.....	118	tk 28280-16-P.....	71
tk 24050-90.....	123	tk 24575-03.....	150	tk 25065-03.....	69	tk 25611-04.....	49	tk 25671-15.....	48	tk 28280-18-P.....	71
tk 24051-20.....	123	tk 24575-04.....	150	tk 25065-04.....	69	tk 25611-15.....	50	tk 25671-18.....	118	tk 28280-20-P.....	71
tk 24053-18.....	124	tk 24575-05.....	150	tk 25070-01.....	69	tk 25612-12.....	50	tk 25672-15.....	48	tk 38723-11.....	153
tk 24055-16.....	124	tk 24578-40.....	150	tk 25070-02.....	69	tk 25613-12.....	50	tk 25673-15.....	48	tk 38724-13.....	152
tk 24056-19.....	124	tk 24578-45.....	150	tk 25070-03.....	69	tk 25618-18.....	51	tk 25675-15.....	48	tk 40099-00.....	158
tk 24057-01.....	124	tk 24578-55.....	150	tk 25070-04.....	69	tk 25619-18.....	51	tk 25677-18.....	48	tk 40100-00.....	158
tk 24057-02.....	124	tk 24580-31.....	151	tk 25071-01.....	69	tk 25620-18.....	51	tk 25678-15.....	48	tk 40100-01.....	158
tk 24261-16.....	125	tk 24582-23.....	151	tk 25071-02.....	69	tk 25621-18.....	51	tk 25679-15.....	48	tk 40100-12.....	158
tk 24263-16.....	125	tk 24585-15.....	152	tk 25071-03.....	69	tk 25622-01.....	117	tk 25685-07.....	122	tk 40100-23.....	158
tk 24270-07.....	125	tk 24585-19.....	152	tk 25071-04.....	69	tk 25622-02.....	117	tk 25685-08.....	122	tk 40100-34.....	158
tk 24270-12.....	125	tk 24585-24.....	152	tk 25072-01.....	69	tk 25622-03.....	117	tk 25685-09.....	122	tk 40100-45.....	158
tk 24272-19.....	125	tk 24586-00.....	153	tk 25072-02.....	69	tk 25622-04.....	117	tk 25685-10.....	122	tk 40100-56.....	158
tk 24277-06.....	125	tk 24586-01.....	153	tk 25072-03.....	69	tk 25622-05.....	117	tk 25685-13.....	121	tk 40100-67.....	158
tk 24278-04.....	127	tk 24588-20.....	151	tk 25072-04.....	69	tk 25622-06.....	117	tk 25685-14.....	121	tk 40100-78.....	158
tk 24278-05.....	127	tk 24589-15.....	152	tk 25073-01.....	69	tk 25622-07.....	117	tk 25685-15.....	121	tk 40101-00.....	158
tk 24278-06.....	127	tk 24590-15.....	152	tk 25073-02.....	69	tk 25622-08.....	117	tk 25685-16.....	121	tk 40102-00.....	158
tk 24278-07.....	127	tk 24605-12.....	154	tk 25073-03.....	69	tk 25623-01.....	119	tk 25686-30.....	63	tk 40102-01.....	158
tk 24278-08.....	127	tk 24605-14.....	154	tk 25073-04.....	69	tk 25623-02.....	119	tk 25686-35.....	63	tk 40102-12.....	158
tk 24279-10.....	127	tk 24606-01.....	154	tk 25074-01.....	69	tk 25623-03.....	119	tk 25687-30.....	63	tk 40102-23.....	158
tk 24279-12.....	127	tk 24606-02.....	154	tk 25074-02.....	69	tk 25623-04.....	119	tk 25687-335.....	63	tk 40102-34.....	158
tk 24279-14.....	127	tk 24606-03.....	154	tk 25074-03.....	69	tk 25623-05 tucar.....	119	tk 25740-01.....	116	tk 40102-45.....	158
tk 24279-16.....	127	tk 24613-00.....	155	tk 25074-04.....	69	tk 25623-06 tucar.....	119	tk 25740-02.....	116	tk 40102-56.....	158
tk 24280-04.....	126	tk 24613-02.....	155	tk 25075-01.....	69	tk 25623-07 tucar.....	119	tk 25740-03.....	116	tk 40102-67.....	158
tk 24280-07.....	126	tk 24614-01.....	155	tk 25075-02.....	69	tk 25623-08 tucar.....	119	tk 25740-04.....	116	tk 40102-78.....	158
tk 24280-09.....	126	tk 24614-02.....	155	tk 25075-03.....	69	tk 25623-09 tucar.....	119	tk 25740-05 tucar.....	116	tk 40105-00.....	159
tk 24280-12.....	126	tk 24614-18.....	156	tk 25075-04.....	69	tk 25623-10 tucar.....	119	tk 25740-06 tucar.....	116	tk 40106-00.....	159
tk 24281-04.....	126	tk 24614-20.....	156	tk 25209-01.....	67	tk 25623-11 tucar.....	119	tk 25740-07 tucar.....	116	tk 40107-00.....	159
tk 24281-07.....	126	tk 24615-18.....	156	tk 25209-02.....	67	tk 25623-12 tucar.....	119	tk 25740-08 tucar.....	116	tk 40910-14.....	115
tk 24281-09.....	126	tk 24616-04.....	156	tk 25210-00.....	67	tk 25623-13.....	119	tk 25740-09 tucar.....	116	tk 40911-14.....	115
tk 24281-12.....	126	tk 24616-05.....	156	tk 25211-00.....	67	tk 25623-14.....	119	tk 25740-10 tucar.....	116	tk 40912-14.....	115
tk 24283-06.....	128	tk 24649-19.....	157	tk 25212-00.....	67	tk 25623-15.....	119	tk 25740-11 tucar.....	116	tk 40913-14.....	115
tk 24284-16.....	128	tk 24654-15.....	157	tk 25213-00.....	67	tk 25623-16.....	119	tk 25740-12 tucar.....	116	tk 40915-14.....	115
tk 24286-16.....	128	tk 24655-15.....	157	tk 25214-00.....	67	tk 25635-11.....	118	tk 25740-13.....	116	tk 40917-14.....	115
tk 24287-04.....	128	tk 24660-18.....	157	tk 25215-00.....	67	tk 25636-11.....	118	tk 25740-14.....	116	tk 40918-14.....	115
tk 24287-07.....	128	tk 24661-18.....	157	tk 25216-00.....	67	tk 25637-11.....	118	tk 25740-15.....	116	tk 40919-14.....	115
tk 24287-09.....	128	tk 25059-01.....	68	tk 25217-00.....	67	tk 25638-11.....	118	tk 25740-16.....	116	tk 48128-15.....	84
tk 24287-12.....	128	tk 25059-02.....	68	tk 25308-01.....	85	tk 25640-15.....	118	tk 26001-11.....	64	tk 48130-01.....	84
tk 24290-10.....	129	tk 25059-03.....	68	tk 25308-02.....	85	tk 25641-15.....	118	tk 26002-11.....	64	tk 48130-02.....	84
tk 24290-12.....	129	tk 25060-01.....	69	tk 25600-15.....	50	tk 25642-15.....	118	tk 26003-11.....	64	tk 48180-01.....	12
tk 24290-14.....	129	tk 25060-02.....	69	tk 25601-15.....	50	tk 25643-15.....	118	tk 26005-12.....	64	tk 48180-02.....	12
tk 24292-03.....	129	tk 25060-03.....	69	tk 25602-01.....	49	tk 25645-13.....	118	tk 26006-13.....	64	tk 48180-03.....	12
tk 24292-04.....	129	tk 25060-04.....	69	tk 25602-02.....	49	tk 25646-13.....	118	tk 26009-12.....	65	tk 48180-04.....	12
tk 24295-02.....	130	tk 25061-01.....	69	tk 25602-03.....	49	tk 25652-13.....	118	tk 26009-13.....	65	tk 50811-14.....	140
tk 24295-04.....	130	tk 25061-02.....	69	tk 25602-04.....	49	tk 25653-13.....	118	tk 26015-02.....	66	tk 50813-01.....	140
tk 24295-06.....	130	tk 25061-03.....	69	tk 25602-18.....	51	tk 25654-12.....	118	tk 26015-03.....	66	tk 50813-02.....	140
tk 24295-08.....	130	tk 25061-04.....	69	tk 25603-01.....	49	tk 25655-12.....	118	tk 26015-04.....	66	tk 50813-03.....	140
tk 24295-10.....	130	tk 25062-01.....	69	tk 25603-02.....	49	tk 25655-12.....	118	tk 26015-05.....	66	tk 50823-13.....	140
tk 24295-12.....	130	tk 25062-02.....	69	tk 25603-03.....	49	tk 25657-12.....	118	tk 28100-14.....	82	tk 50828-01.....	142
tk 24295-15.....	130	tk 25062-03.....	69	tk 25603-04.....	49	tk 25658-13.....	118	tk 28140-15.....	82	tk 50828-02.....	142
tk 24295-18.....	130	tk 25062-04.....	69	tk 25603-18.....	51	tk 25659-13.....	118	tk 28140-15-P.....	71	tk 50828-03.....	142
tk 24296-01.....	130	tk 25063-01.....	69	tk 25606-18.....	51	tk 25662-13.....	118	tk 28160-15.....	82	tk 50828-04.....	142
tk 24296-02.....	130	tk 25063-02.....	69	tk 25607-18.....	51	tk 25663-13.....	118	tk 28160-15-P.....	71	tk 50834-01.....	141
tk 24296-03.....	130	tk 25063-03.....	69	tk 25610-01.....	49	tk 25664-18.....	118	tk 28160-19.....	82	tk 50834-02.....	141
tk 24298-01.....	131	tk 25063-04.....	69	tk 25610-02.....	49	tk 25665-18.....	118	tk 28160-19-P.....	71	tk 50834-03.....	141
tk 24298-02.....	131	tk 25064-01.....	69	tk 25610-03.....	49	tk 25666-18.....	118	tk 28160-25.....	82	tk 50836-35.....	141

Nummernverzeichnis
Numerical index
Index numériques
Indice numerico
Indice dei numeri d'articolo

tk 50836-50.....	141	tk 52731-08.....	139
tk 50836-75.....	141	tk 52731-09.....	139
tk 50836-90.....	141	tk 52735-01.....	136
tk 50840-45.....	142	tk 52738-21.....	139
tk 50840-75.....	142	tk 52740-21.....	139
tk 51180-19.....	149	tk 52742-25.....	138
tk 51182-19.....	149	tk 52742-40.....	138
tk 51184-20.....	149	tk 52744-24.....	139
tk 51188-01.....	149	tk 52746-19.....	139
tk 51188-21.....	149	tk 52747-19.....	139
tk 51607-19.....	132	tk 52749-18.....	136
tk 51613-16.....	132	tk 52750-14.....	136
tk 51617-16.....	132	tk 52751-23.....	136
tk 51625-19.....	133	tk 52755-21.....	138
tk 51627-18.....	133	tk 52756-21.....	138
tk 51631-20.....	135	tk 55210-01.....	68
tk 51636-21.....	135	tk 55210-02.....	68
tk 51637-19.....	132	tk 55210-03.....	68
tk 51637-22.....	132	tk 56500-00.....	162
tk 51643-22.....	135	tk 85100-01.....	161
tk 51644-21.....	134	tk 85100-03.....	161
tk 51645-20.....	134	tk 85101-01.....	161
tk 51646-02.....	133	tk 85101-03.....	161
tk 51648-00.....	160	tk 85102-01.....	161
tk 51649-00.....	160	tk 85102-03.....	161
tk 51655-20.....	143	tk 85103-01.....	161
tk 51657-20.....	143	tk 85103-03.....	161
tk 51661-01.....	143	tk 85104-01.....	161
tk 51661-02.....	143	tk 85104-03.....	161
tk 51665-21.....	144		
tk 51669-21.....	144		
tk 51671-21.....	144		
tk 51672-21.....	144		
tk 51683-01.....	145		
tk 51683-02.....	145		
tk 51683-03.....	145		
tk 51685-21.....	145		
tk 51686-01 tucar.....	146		
tk 51686-03 tucar.....	146		
tk 51686-05 tucar.....	146		
tk 51686-07 tucar.....	146		
tk 51686-09 tucar.....	146		
tk 51695-01.....	148		
tk 51695-02.....	148		
tk 51695-03.....	148		
tk 51697-23.....	148		
tk 51755-00.....	160		
tk 52715-01.....	100		
tk 52715-02.....	100		
tk 52715-03.....	100		
tk 52717-22.....	101		
tk 52719-22.....	101		
tk 52723-16.....	101		
tk 52725-08.....	101		
tk 52725-10.....	101		
tk 52730-06.....	136		
tk 52730-07.....	136		
tk 52730-09.....	136		
tk 52730-11.....	136		
tk 52731-05.....	139		

Inhaltsverzeichnis Index

Tables de matières Indice Indice

ADLERKREUTZ Pinzetten.....	57	CONVERSE Schere	34
ADSON Arterienklemmen.....	80	CORONAL LIFT Wundhaken.....	98
ADSON Pinzetten	54, 55	COTTLE Elevatorien	132-135
ADSON-BROWN Pinzetten	54	COTTLE Knorpelquetscher	160
ADSON-GRAEFE Pinzette	54	COTTLE Meißel	125, 126, 128
ALLIS Gewebefasszangen	82	COTTLE Nasenraspel.....	144
ALLIS Gewebefasszangen PRIMUSLINE	71	COTTLE Nasenspekula	141-142
ALLIS-ADAIR Gewebefasszange.....	82	COTTLE Trachealhäkchen.....	84, 85, 87, 88
ALLIS-BABY Gewebefasszange	82	COTTLE-KAZANJIAN Knochensplitterzange.....	157
ALM Wundsperrerr.....	95	COTTLE-NEIVERT Nasenhäkchen.....	88
Anatomische Pinzetten - Chirurgische Pinzetten	52-59	COTTLE-WALSHAM Septumzangen.....	148
Anlegepinzetten für Gefäßclips	68	CRILE Arterienklemmen	78
Approximatoren, Gefäßclips.....	69	CRILE Arterienklemmen PRIMUSLINE	73
Approximatoren, Gefäßclips nach Biemer.....	67	CRILE Nasenhaken	85
Arterienklemmen.....	71-81	CRILE-MURRAY Nadelhalter.....	105
Arterienklemmen PRIMUSLINE	71-75	CRILE-RANKIN Arterienklemmen	78
ASCH Septumzange	148	CRILE-RANKIN Arterienklemmen PRIMUSLINE	73
Atraumatische Pinzetten	60-62	CRILE-WOOD Nadelhalter	105
AUFRICHT Nasenhaken	86	CUSHING anatomische Pinzetten	52
AUFRICHT Nasenraspeln.....	144	DANDY Arterienklemmen.....	77
AUFRICHT Scheren.....	40	DAVIS Face-Lift-Scheren.....	42
Augenscheren.....	45-47	DE BAKEY atraumatische Pinzetten	61, 62
BABCOCK Gewebefasszangen PRIMUSLINE	71	DE BAKEY BAYONET atraumatische Pinzetten.....	60
BABY-ADSON Arterienklemmen.....	81	DE Baky Nadelhalter.....	111
BABY-CRILE-WOOD Nadelhalter	106	DE BAKEY-GERALD atraumatische Pinzetten	60
BABY-METZENBAUM Scheren PRIMUSLINE	17	DERF Nadelhalter	105
BABY-MIXTER Arterienklemmen	81	Dermatome.....	9-10
BALLENGER-HAJEK Septumelevatorien	132	DESMARRES Lidhalter.....	90
BARRAQUER Mikronadelhalter.....	117	DIETHRICH Nadelhalter.....	113
BARRAQUER Nadelhalter	114	DUEHRSEN anatomische Pinzette	57
BARRON Skalpellgriff	7	Face-Lift-Scheren.....	42-43
BELUCCI Wundsperrerr	103	Feine Scheren.....	32-34
BEUSE Scheren	34	FERREIRA Brust Dissektoren.....	92
BEYER Hohlmeißelzange	156	FERREIRA Wundhaken	99
BIEMER Approximatoren, Gefäßclips	67	FISCHER Sehnenstripper.....	151
Bleihände.....	12	FOERSTER (BALLENGER) Schwammzangen.....	83
BLUMENTHAL Hohlmeißelzangen	154	FOMON Meißel	127
BOETTCHER Nasenschere.....	44	FOMON Nasenhäkchen	84, 88
BÖHLER Hohlmeißelzangen	155	FOMON Nasenraspeln.....	145-146
BÖHLER Knochensplitterzangen	157	FOMON Nasenscheren.....	44
BONN Augenscheren.....	45	FOSTER-GILLIES Nadelhalter	109
BOWMAN Tränenkanal-Dilatatoren	158	FREEMAN Mamillenringe.....	11
BRAND Sehnenfasszangen.....	152	FREEMAN Wundhaken	96-97, 99
BROPHY (SULLIVAN) Scheren.....	27	FREEMAN-KAYE Scheren	40
BROPHY Chirurgische Pinzetten	58	FREER Elevatorien	133, 135
Brust Dissektoren.....	91-93	FRIEDMAN Hohlmeißelzange	154
BUNELL Sehnenstripper.....	150, 151	GALLAHER Nasenraspeln.....	145
CAPLAN Septumzange	149	Gefäßdilatatoren.....	66
CAROLL Sehnenfasszange	153	GERALD anatomische Pinzetten	59
CASTANARES Face-Lift-Scheren.....	43	Gewebe- und Darmfasszangen	82
CASTROVIEJO Mikronadelhalter.....	115	Gewebe- und Darmfasszangen PRIMUSLINE	71
CASTROVIEJO Mikroscheren	50	GILLIES chirurgische Pinzette	53
CASTROVIEJO-JACOBSON Nadelhalter	114	GILLIES Nadelhalter	109
CHANG Mamillenring	11	GILLIES Nasenhäkchen	84
Chirurgische Pinzetten - Anatomische Pinzetten	52-59	GOLDMAN-FOX Scheren.....	41
Chirurgische Scheren.....	24-27	GORNEY PLATYSMA Scheren.....	38
Chirurgische Scheren - Präparierscheren	28-30	GORNEY Scheren	37
CINELLI Meißel	127	GORNEY Wundhaken.....	96
COLLIN Hammer	123	GORNEY-DELICATE Scheren	39
CONVERSE Nasenhaken.....	86	GORNEY-FREEMAN Scheren.....	38

Inhaltsverzeichnis
Index

Tables de matières
Indice
Indice

GRADLE Schere 32

GRAEFE Pinzetten 56

GREENBERG PAR Scheren 46

GREGORY Schere 43

GROSSMAN Mamillenring 11

HAJEK Hammer 123

HALLE Elevatorium 132

HALSEY Nadelhalter 107

HALSTED-MOSQUITO Arterienklemmen 76

HALSTED-MOSQUITO Arterienklemmen **PRIMUSLINE** 72

Hämmer 123-124

HARTMANN Arterienklemmen 76

HARTMANN Arterienklemmen **PRIMUSLINE** 72

HARTMANN-HALLE Nasenspekula 140

HEANEY Nadelhalter 110

HEGAR-BAUMGARTNER Nadelhalter 106

Hohlmeißelzangen 154-156

Hohlsonden 159

HOLTZHEIMER Wundsperrer 95

HUMBY Dermatom 10

Instrumenten-Kassetten aus Edelstahl 161

Irisscheren 31

ITERSON Trachealhäkchen 88

JACKSON Trachealhäkchen 89

JACOBSON Mikronadelhalter 116

JOSEPH Elevatorium 132

JOSEPH Nasenhäkchen 85

JOSEPH Nasensägen 143

JOSEPH Scheren 37

JOSEPH Scheren **PRIMUSLINE** 20

KAHN Scheren 41

KAYE BLEPHAROPLASTY Scheren 47

KAYE RIBBON TYPE Scheren 47

KAYE Scheren 39

KELLY Arterienklemmen 79

KELLY Arterienklemmen **PRIMUSLINE** 73

KELLY Scheren 26

KELLY Scheren **PRIMUSLINE** 20

KELLY-RANKIN Arterienklemmen 79

KELLY-RANKIN Arterienklemmen **PRIMUSLINE** 73

KILIAN Meißel 125

KILIAN Nasenspekula 142

KILIAN-CALUS Meißel 125

KILNER (RAGNELL) Scheren 36

KILNER Nadelhalter 110

KILNER Nasenhäkchen 84, 87

KLEINERT-KURTZ Sehnenstripper 151

KNAPP (ROLLET) Trachealhäkchen 90

KNAPP Scheren 32

KNIGHT Nasenschere 44

Knochensplitterzangen 157

Knorpelquetscher 160

KOCHER Arterienklemmen 80

KOCHER Arterienklemmen **PRIMUSLINE** 74

KOCHER-FINO Arterienklemmen **PRIMUSLINE** 75

LANGE Trachealhäkchen 84

LERICHE Arterienklemmen 79

LEXER Scheren 26

LEXER Scheren **PRIMUSLINE** 18

LICHTENBERG Nadelhalter 113

LOCKLIN Scheren 33

LOCKWOOD Gewebefasszange 82

LUCAE Hämmer 124

LUKENS Trachealhäkchen 89

MACCOLLUM-DINGMAN Brust Dissektor 92

Mamillenringe 11

MARQUARDT Hohlmeißelzange 156

MARTINEZ-KILNER Nasenhäkchen 87

MASING Elevatorium 135

MATHIEU-OLSEN Nadelhalter 106

MAYO Scheren 24

MAYO-HEGAR Nadelhalter 108

MAYO-LEXER Scheren **PRIMUSLINE** 18

MAYO-STILLE Scheren **PRIMUSLINE** 19

MC DONALD Raspatorium 137

MC INDOE anatomische Pinzetten 53

MC INDOE Scheren 33

MEAD Hämmer 123

Meißel für die Kieferchirurgie 138

Meißel zur Nasenplastik 125-131

Messinstrumente 11

METZENBAUM Scheren **PRIMUSLINE** 16

METZENBAUM-FINO Scheren 30

METZENBAUM-FINO Scheren **PRIMUSLINE** 17

METZENBAUM-NELSON Scheren 28-29

MEYERDING Wundhaken 95

MICRO-ADSON Pinzetten 54-55

MICRO-MOSQUITO Arterienklemmen 76

MICRO-MOSQUITO Arterienklemmen **PRIMUSLINE** 72

MIDDLETON-JANSEN Septumzangen 149

Mikroklingen Halter - Mikroklingen 6

Mikronadelhalter 115-122

Mikronadelhalter mit Rundgriff 117-119

Mikro-Pinzetten 63-65

Mikro-Scheren 48-50

MILIGAN Wundsperrer 103

MINI-FRIEDMAN Hohlmeißelzangen 154

MINI-RYDER Nadelhalter 113

MODELL WIEN Nasenspekula 141

MOSQUITO-DANDY Arterienklemme 77

Nadelhalter 105-122

Nadelhalter, Mikro- 115-122

Nadelhalter, Titan- 121-122

Nasen- und Trachealhäkchen 84-88

Nasenraspeln 144-146

Nasenraspeln mit Hartmetall 146

Nasensägen 143

Nasenscheren 44

Nasenspekula 140-142

NEIVERT Meißel 131

NEIVERT Nadelhalter 110

NEIVERT Trachealhäkchen 88

NEIVERT-ANDERSON Meißel 131

NEUMANN Schere 33

OBWEGESER Raspatorien 136, 139

OBWEGESER Wundhaken 100-101

OEHLER chirurgische Pinzetten 53

OLSEN-HEGAR Nadelhalter 107

PARTSCH Hammer 124

PAR-TYPE Scheren 46

Inhaltsverzeichnis Index

Tables de matières Indice Indice

PÉAN Arterienklemmen	78	Trachealhäkchen	89-90
PÉAN Arterienklemmen <i>PRIMUSLINE</i>	74	Tränenkanal-Dilatatoren.....	158-159
PÉAN-FINO Arterienklemmen <i>PRIMUSLINE</i>	75	TRAVERS Wundsperrerr.....	103
PECK-JOSEF Scheren.....	27	Tupfer- und Schwammzangen	83
PIERSE Mikro-Pinzetten	65	TYP JUWELIER Mikro-Pinzetten.....	64
Pinzetten	52-65	ULTRA-MICRO-ADSON (BRAKA) Pinzette	55
Pinzetten, atraumatische	60-62	VANNAS Mikro-Scheren.....	50
Pinzetten, Mikro-.....	63-65	VASCULAR Nadelhalter.....	111
POTTS-SMITH chirurgische Pinzetten.....	58	VOLKMANN Wundhaken	94
PROVIDENCE-HOSPITAL Arterienklemmen	77	WALTER Meißel.....	129
QUINBY Schere	33	WANGENSTEEN Pinzetten	53
RAGNELL-DAVIS Wundhaken	95	WATSON Dermatom	10
RAMPLEY Schwammzangen.....	83	WATSON-CHEYNE Raspatorium.....	137
Raspatorien - Elevatorien	136-137, 139	WAUGH Pinzetten.....	57
REES Bulldog Schere.....	42	WEBSTER Nadelhalter	106
REES Scheren.....	42	Weichteilhaken für die Kieferchirurgie	100-101
REYNOLDS (JAMESON) Scheren	36	WEITLANER-LOKTITE Wundsperrerr.....	102
REYNOLDS Scheren <i>PRIMUSLINE</i>	19	WILDER Tränenkanal-Dilatatoren	159
RIBBON STEVENS Scheren	34	WILLIAMS Gewebefasszange	82
RUBIN Meißel	129	WILLIAMS Tränenkanal-Dilatatoren	158
RUBIN Septumzange	149	WULLSTEIN Wundsperrerr.....	103
RUSKIN Hohlmeißelzangen	156	Wundhaken.....	94-101
RUSKIN-LISTON Knochensplitterzangen	157	Wundsperrerr.....	102-103
RYDER Nadelhalter	113	YANCOSKIE Wundhaken.....	98
SAROT Nadelhalter	110	YASARGIL Mikro-Nadelhalter	119
Scheren	16-51	ZAUFAL-JANSEN Hohlmeißelzange.....	156
Scheren für plastische Operationen	36-41		
Scheren, Augen.....	45-47		
Scheren, chirurgische	24-30		
Scheren, Face-Lift.....	42-43		
Scheren, feine	32-34		
Scheren, Iris-.....	31		
Scheren, Mikro-.....	48-51		
Scheren, Nasen-.....	44		
Scheren, Präparier-.....	28-30		
Scheren, Sehnen-.....	35		
SCHINK Dermatom.....	9		
SCHWARZ Nasenspekulum	140		
Sehnenfasszangen	152-153		
Sehnenscheren.....	35		
Sehnenstripper.....	150-151		
SEMKEN Pinzetten	52		
SENN-MUELLER Wundhaken.....	94		
Septum-Elevatorien.....	132-135		
Septumzangen.....	148-149		
SHEA Scheren	45		
SHEEHAN Nasenmeißel.....	130		
SILVER Nasenmeißel	130		
Skalpellgriffe	7		
Skalpellklingen	8		
STELLBRINK Hohlmeißelzangen.....	155		
STEVENS Scheren	35		
STEVENS Scheren <i>PRIMUSLINE</i>	21		
Strabismus-Scheren.....	32		
STRANDELL-STILLE Wundhaken	94		
TAYLOR Pinzetten	59		
THOMS-ALLIS Gewebefasszange.....	82		
THOREK Schere.....	44		
TIECK-HALLE Nasenspekulum.....	140		
TIERSCH Dermatom	9		

Inhaltsverzeichnis
Index

Tables de matières
Indice
Indice

ADLERKREUTZ forceps.....57

ADSON forceps 54, 55

ADSON haemostatic forceps.....80

ADSON-BROWN forceps54

ADSON-GRAEFE forceps.....54

ALLIS tissue holding forceps.....82

ALLIS tissue holding forceps *PRIMUSLINE*.....71

ALLIS-ADAIR tissue holding forceps82

ALLIS-BABY tissue holding forceps.....82

ALM self retaining retractors95

Anatomic forceps - dressing forceps 52-59

Applying forceps for vessel clips.....68

Applying forceps, vessel clips.....69

Applying forceps, vessel clips BIEMER67

Areola markers 11

ASCH septum forceps148

Atraumatic forceps.....60-62

AUFRICHT nasal hooks.....86

AUFRICHT nasal rasps.....144

AUFRICHT scissors.....40

BABCOCK tissue holding forceps *PRIMUSLINE*.....71

BABY-ADSON haemostatic forceps.....81

BABY-CRILE-WOOD needle holder.....106

BABY-METZENBAUM scissors *PRIMUSLINE*17

BABY-MIXTER haemostatic forceps81

BALLENGER-HAJEK septum elevators.....132

BARRAQUER micro-needle holders.....117

BARRAQUER needle holders114

BARRON scalpel handle7

BELUCCI self retaining retractors103

BEUSE scissors.....34

BEYER bone rongeur.....156

BIEMER applying forceps, vessel clips.....67

Blepharoplasty scissors45-47

BLUMENTHAL bone rongeurs.....154

BOETTCHER nasal scissors44

BÖHLER bone cutting forceps.....157

BÖHLER bone rongeurs.....155

Bone crusher160

Bone cutting forceps157

Bone rongeurs 154-156

BONN blepharoplasty scissors.....45

BOWMAN lacrimal dilators158

BRAND tendon holding forceps.....152

BROPHY (SULLIVAN) scissors27

BROPHY dissecting forceps58

BUNELL tendon strippers.....150, 151

CAPLAN septum forceps.....149

CAROLL tendon holding forceps153

CASTANARES face-lift scissors.....43

CASTROVIEJO micro scissors.....50

CASTROVIEJO micro-needle holders.....115

CASTROVIEJO-JACOBSON needle holders.....114

CHANG areola marker 11

Chisels for rhinoplasty 125-131

CINELLI chisels.....127

COLLIN mallet123

CONVERSE nasal hook86

CONVERSE scissors34

CORONAL LIFT retractor98

COTTLE bone crusher.....160

COTTLE chisels.....125, 126, 128

COTTLE elevators132-135

COTTLE nasal rasp144

COTTLE nasal specula141-142

COTTLE trachea hooklets.....84, 85, 87, 88

COTTLE-KAZANJIAN bone cutting forceps.....157

COTTLE-NEIVERT nasal hooklet88

COTTLE-WALSHAM septum forceps148

Cotton swab and sponge holding forceps.....83

CRILE haemostatic forceps78

CRILE haemostatic forceps *PRIMUSLINE*73

CRILE nasal hooks85

CRILE-MURRAY needle holder105

CRILE-RANKIN haemostatic forceps78

CRILE-RANKIN haemostatic forceps *PRIMUSLINE*.....73

CRILE-WOOD needle holders105

CUSHING dressing forceps52

DANDY haemostatic forceps.....77

DAVIS face-lift scissors.....42

DE BAKEY atraumatic forceps.....61, 62

DE BAKEY BAYONET atraumatic forceps.....60

DE Bakey needle holders.....111

DE BAKEY-GERALD atraumatic forceps60

DERF needle holders105

Dermatomes.....9-10

DESMARRES retractor.....90

DIETHRICH needle holders.....113

Dissecting forceps - Dressing forceps 52-59

Dissecting scissors.....24-30

DUEHRSSSEN dressing forceps57

Face-lift scissors.....42-43

FERREIRA mamaplasty retractors.....92

FERREIRA retractors.....99

Fine scissors.....32-34

FISCHER tendon strippers.....151

FOERSTER (BALLENGER) sponge holding forceps83

FOMON chisels.....127

FOMON nasal hooklet84, 88

FOMON nasal rasps.....145-146

FOMON nasal scissors44

Forceps.....52-65

Forceps, atraumatic60-62

Forceps, micro-63-65

FOSTER-GILLIES needle holders109

FREEMAN areola markers 11

FREEMAN retractors96-97, 99

FREEMAN-KAYE scissors40

FREER elevators133, 135

FRIEDMAN bone rongeur.....154

GALLAHER nasal rasps.....145

GERALD dressing forceps59

GILLIES dissecting forceps.....53

GILLIES nasal hooklet.....84

GILLIES needle holders109

GOLDMAN-FOX scissors.....41

GORNEY PLATYSMA scissors.....38

GORNEY retractors.....96

GORNEY scissors37

GORNEY-DELICATE scissors39

English

Inhaltsverzeichnis Index

Tables de matières Indice Indice

GORNEY-FREEMAN scissors	38	LOCKLIN scissors	33
GRADLE scissors	32	LOCKWOOD tissue holding forceps	82
GRAEFE forceps	56	LUCAE mallets	124
GREENBERG PAR scissors	46	LUKENS trachea hooklet	89
GREGORY scissors	43	MACCOLLUM-DINGMAN mamaplasty retractor	92
GROSSMAN areola marker	11	Mallets	123-124
Haemostatic forceps	71-81	Mamaplasty retractors	91-93
Haemostatic forceps PRIMUSLINE	71-75	MARQUARDT bone rongeur	156
HAJEK mallet	123	MARTINEZ-KILNER nasal hooklet	87
HALLE elevator	132	MASING elevator	135
HALSEY needle holders	107	MATHIEU-OLSEN needle holders	106
HALSTED-MOSQUITO haemostatic forceps	76	MAYO scissors	24
HALSTED-MOSQUITO haemostatic forceps PRIMUSLINE	72	MAYO-HEGAR needle holders	108
HARTMANN haemostatic forceps	76	MAYO-LEXER scissors PRIMUSLINE	18
HARTMANN haemostatic forceps PRIMUSLINE	72	MAYO-STILLE scissors PRIMUSLINE	19
HARTMANN-HALLE nasal specula	140	MC DONALD periosteal raspatory	137
HEANEY needle holders	110	MC INDOE dressing forceps	53
HEGAR-BAUMGARTNER needle holders	106	MC INDOE scissors	33
HOLTZHEIMER self retaining retractors	95	MEAD mallets	123
HUMBY dermatome	10	Measuring instruments	11
Instrument trays, stainless steel	161	METZENBAUM scissors PRIMUSLINE	16
Iris scissors	31	METZENBAUM-FINO scissors	30
ITERSON trachea hooklets	88	METZENBAUM-FINO scissors PRIMUSLINE	17
JACKSON trachea hooklets	89	METZENBAUM-NELSON scissors	28-29
JACOBSON micro-needle holders	116	MEYERDING retractors	95
JOSEPH elevator	132	MICRO-ADSON forceps	54-55
JOSEPH nasal hooklet	85	Micro-blade holder - micro-blades	6
JOSEPH nasal saws	143	Micro-forceps	63-65
JOSEPH scissors	37	MICRO-MOSQUITO haemostatic forceps	76
JOSEPH scissors PRIMUSLINE	20	MICRO-MOSQUITO haemostatic forceps PRIMUSLINE	72
KAHN scissors	41	Micro-needle holders	115-122
KAYE BLEPHAROPLASTY scissors	47	Micro-needle holders, round handle	117-119
KAYE RIBBON TYPE scissors	47	Micro-scissors	48-50
KAYE scissors	39	MIDDLETON-JANSEN septum forceps	149
KELLY haemostatic forceps	79	MILIGAN self retaining retractor	103
KELLY haemostatic forceps PRIMUSLINE	73	MINI-FRIEDMAN bone rongeurs	154
KELLY scissors	26	MINI-RYDER needle holders	113
KELLY scissors PRIMUSLINE	20	MODELL WIEN nasal specula	141
KELLY-RANKIN haemostatic forceps	79	MOSQUITO-DANDY haemostatic forceps	77
KELLY-RANKIN haemostatic forceps PRIMUSLINE	73	Nasal and trachea hooklets	84-88
KILIAN chisel	125	Nasal rasps	144-146
KILIAN nasal specula	142	Nasal rasps with TC	146
KILIAN-CALUS chisel	125	Nasal saws	143
KILNER (RAGNELL) scissors	36	Nasal scissors	44
KILNER nasal hooklet	84, 87	Nasal specula	140-142
KILNER needle holder	110	Needle holders	105-122
KLEINERT-KURTZ tendon strippers	151	Needle holders, Micro-	115-122
KNAPP (ROLLET) trachea hooklet	90	Needle holders, Titanium-	121-122
KNAPP scissors	32	NEIVERT chisel	131
KNIGHT nasal scissors	44	NEIVERT needle holder	110
KOCHER haemostatic forceps	80	NEIVERT trachea hooklet	88
KOCHER haemostatic forceps PRIMUSLINE	74	NEIVERT-ANDERSON chisels	131
KOCHER-FINO haemostatic forceps PRIMUSLINE	75	NEUMANN scissors	33
Lacrimal dilators	158-159	OBWEGESER periosteal raspatories	136, 139
LANGE trachea hooklet	84	OBWEGESER retractors	100-101
Leadhands	12	OEHLER dressing forceps	53
LERICHE haemostatic forceps	79	OLSEN-HEGAR needle holders	107
LEXER scissors	26	Osteotomes for maxillo-facial surgery	138
LEXER scissors PRIMUSLINE	18	PARTSCH mallet	124
LICHTENBERG needle holders	113	PAR-TYPE scissors	46

Inhaltsverzeichnis
Index

Tables de matières
Indice
Indice

PÉAN haemostatic forceps78
 PÉAN haemostatic forceps *PRIMUSLINE*.....74
 PÉAN-FINO haemostatic forceps *PRIMUSLINE*75
 PECK-JOSEF scissors.....27
 Periosteal raspatories - elevators..... 136-137, 139
 PIERSE micro-forceps65
 POTTS-SMITH dressing forceps58
 Probes159
 PROVIDENCE-HOSPITAL haemostatic forceps77
 QUINBY scissors33
 RAGNELL-DAVIS retractor.....95
 RAMPLEY sponge holding forceps83
 REES Bulldog scissors42
 REES scissors42
 Retractors.....94-101
 REYNOLDS (JAMESON) scissors36
 REYNOLDS scissors *PRIMUSLINE*19
 RIBBON STEVENS scissors34
 RUBIN chisels.....129
 RUBIN septum forceps149
 RUSKIN bone rongeurs.....156
 RUSKIN-LISTON bone cutting forceps157
 RYDER needle holders.....113
 SAROT needle holders.....110
 Scalpel blades8
 Scalpel handle.....7
 SCHINK dermatome9
 SCHWARZ nasal speculum140
 Scissors16-51
 Scissors for plastic surgery.....36-41
 Scissors, blepharoplasty-.....45-47
 Scissors, dissecting.....24-30
 Scissors, face-lift42-43
 Scissors, fine.....32-34
 Scissors, Iris-.....31
 Scissors, micro-.....48-51
 Scissors, nasal-.....44
 Scissors, tendon-.....35
 Self retaining retractors102-103
 SEMKEN forceps52
 SENN-MUELLER retractors94
 Septum forceps148-149
 Septum-elevators.....132-135
 SHEA scissors45
 SHEEHAN nasal chisels.....130
 SILVER nasal chisels.....130
 Soft tissue retractors for maxillo facial surgery..... 100-101
 STELLBRINK bone rongeurs155
 STEVENS scissors35
 STEVENS scissors *PRIMUSLINE*21
 Strabismus scissors32
 STRANDELL-STILLE retractors94
 TAYLOR forceps59
 Tendon holding forceps152-153
 Tendon strippers150-151
 Tenotomy scissors.....35
 THOMS-ALLIS tissue holding forceps82
 THOREK scissors.....44
 TIECK-HALLE nasal speculum140
 TIERSCH dermatome.....9

Tissue and intestinal holding forceps.....82
 Tissue and intestinal holding forceps *PRIMUSLINE*.....71
 Trachea hooklets89-90
 TRAVERS self retaining retractor103
 TYP JUWELIER micro-forceps.....64
 ULTRA-MICRO-ADSON (BRAKA) forceps55
 VANNAS micro-scissors.....50
 VASCULAR needle holders.....111
 Vessel dilators66
 VOLKMANN retractors94
 WALTER chisels129
 WANGENSTEEN forceps.....53
 WATSON dermatome.....10
 WATSON-CHEYNE periosteal raspatory.....137
 WAUGH forceps.....57
 WEBSTER needle holders106
 WEITLANER-LOKTITE self retaining retractors.....102
 WILDER lacrimal dilators159
 WILLIAMS lacrimal dilators158
 WILLIAMS tissue holding forceps.....82
 WULLSTEIN self retaining retractors.....103
 YANCOSKIE retractor98
 YASARGIL micro-needle holders119
 ZAUFAL-JANSEN bone rongeur.....156

English

Inhaltsverzeichnis Index

Tables de matières Indice Indice

ADLERKREUTZ pinces à dissection.....	57	COLLIN maillet.....	123
ADSON pinces à dissection.....	54, 55	Contenaires d'instruments.....	161
ADSON pinces hémostatiques.....	80	CONVERSE ciseaux.....	34
ADSON-BROWN pinces à dissection.....	54	CONVERSE écarteur nasal.....	86
ADSON-GRAEFE pince à dissection.....	54	CORONAL LIFT écarteur.....	98
ALLIS pinces à tissu.....	82	COTTLE broyeur pour os.....	160
ALLIS pinces à tissu PRIMUSLINE	71	COTTLE ciseaux-burins.....	125, 126, 128
ALLIS-ADAIR pince à tissu.....	82	COTTLE écarteurs trachéales.....	84, 85, 87, 88
ALLIS-BABY pince à tissu.....	82	COTTLE éleveurs.....	132-135
ALM écarteurs autostatiques.....	95	COTTLE râpe nasal.....	144
Approximateurs, clips.....	69	COTTLE spéculums nasaux.....	141-142
Approximateurs, clips, Biemer.....	67	COTTLE-KAZANJIAN pince coupante à os.....	157
ASCH pince pour la cloison nasal.....	148	COTTLE-NEIVERT écarteur nasal.....	88
AUFRIEHT ciseaux.....	40	COTTLE-WALSHAM pinces pour la cloison nasal.....	148
AUFRIEHT écarteurs nasales.....	86	CRILE écarteurs nasales.....	85
AUFRIEHT râpes nasales.....	144	CRILE pinces hémostatiques.....	78
BABCOCK pinces à tissu PRIMUSLINE	71	CRILE pinces hémostatiques PRIMUSLINE	73
BABY-ADSON pinces hémostatiques.....	81	CRILE-MURRAY porte-aiguilles.....	105
BABY-CRILE-WOOD porte-aiguilles.....	106	CRILE-RANKIN pinces hémostatiques.....	78
BABY-METZENBAUM ciseaux PRIMUSLINE	17	CRILE-RANKIN pinces hémostatiques PRIMUSLINE	73
BABY-MIXTER pinces hémostatiques.....	81	CRILE-WOOD porte-aiguilles.....	105
BALLENGER-HAJEK éleveurs pour la cloison nasal.....	132	CUSHING pinces à dissection.....	52
BARRAQUER porte-aiguilles.....	114	DANDY pinces hémostatiques.....	77
BARRAQUER porte-aiguilles micro.....	117	DAVIS ciseaux pour le face-lift.....	42
BARRON manche de bistouri.....	7	DE BAKEY BAYONET pinces à dissection atraumatiques.....	60
BELUCCI écarteurs autostatiques.....	103	DE BAKEY pinces à dissection atraumatiques.....	61, 62
BEUSE ciseaux.....	34	DE Bakey porte-aiguilles.....	111
BEYER pince gouge.....	156	DE BAKEY-GERALD pinces à dissection atraumatiques.....	60
BIEMER approximateurs, clips.....	67	DERF porte-aiguilles.....	105
BLUMENTHAL pinces gorges.....	154	Dermatomes.....	9-10
BOETTCHER ciseaux nasal.....	44	DESMARRES écarteurs.....	90
BÖHLER pinces coupantes à os.....	157	DIETHRICH porte-aiguilles.....	113
BÖHLER pinces gorges.....	155	Dilatateurs pour le canal lacrymal.....	158-159
BONN ciseaux pour blépharoplastie.....	45	Dilatateurs vasculaires.....	66
BOWMAN dilateurs pour le canal lacrymal.....	158	DUEHRSEN pince à dissection.....	57
BRAND pinces pour saisir les tendons.....	152	Ecarteurs.....	94-101
BROPHY (SULLIVAN) ciseaux.....	27	Ecarteurs autostatiques.....	102-103
BROPHY pinces à dissection à griffes.....	58	Ecarteurs mammaires.....	91-93
Broyeur pour os.....	160	Ecarteurs pour la chirurgie maxillo-faciale.....	100-101
BUNELL instruments à écorcher les tendons.....	150, 151	Ecarteurs trachéales.....	89-90
CAPLAN pince pour la cloison nasal.....	149	Ecarteurs trachéales et nasales.....	84-88
CAROLL pince pour saisir les tendons.....	153	Eleveurs pour la cloison nasale.....	132-135
CASTANARES ciseaux pour le face-lift.....	43	FERREIRA écarteurs.....	99
CASTROVIEJO ciseaux micro.....	50	FERREIRA écarteurs mammaires.....	92
CASTROVIEJO porte-aiguilles micro.....	115	FISCHER instruments à écorcher les tendons.....	151
CASTROVIEJO-JACOBSON porte-aiguilles.....	114	FOERSTER (BALLENGER) pinces à éponges.....	83
CHANG marqueur pour l'aréole.....	11	FOMON ciseaux nasales.....	44
CINELLI ciseaux-burins.....	127	FOMON ciseaux-burins.....	127
Ciseaux.....	16-51	FOMON écarteurs nasales.....	84, 88
Ciseaux à chirurgie.....	24-27	FOMON râpes nasales.....	145-146
Ciseaux à chirurgie – ciseaux à dissection.....	28-30	FOSTER-GILLIES porte-aiguilles.....	109
Ciseaux à iridectomie.....	31	FREEMAN écarteurs.....	96-97, 99
Ciseaux à strabisme.....	32	FREEMAN marqueurs pour l'aréole.....	11
Ciseaux à tendons.....	35	FREEMAN-KAYE ciseaux.....	40
Ciseaux fines.....	32-34	FREER éleveurs.....	133, 135
Ciseaux nasales.....	44	FRIEDMAN pince gouge.....	154
Ciseaux pour blépharoplastie.....	45-47	GALLAHER râpes nasales.....	145
Ciseaux pour la chirurgie plastique.....	36-41	GERALD pinces à dissection.....	59
Ciseaux pour le face-lift.....	42-43	GILLIES écarteur nasal.....	84
Ciseaux, micro-.....	48-51	GILLIES pince à dissection à griffes.....	53

Inhaltsverzeichnis
Index

Tables de matières
Indice
Indice

GILLIES porte-aiguilles 109
 GOLDMAN-FOX ciseaux 41
 GORNEY ciseaux 37
 GORNEY écarteur 96
 GORNEY PLATYSMA ciseaux 38
 GORNEY-DELICATE ciseaux 39
 GORNEY-FREEMAN ciseaux 38
 GRADLE ciseaux 32
 GRAEFE pinces à dissection 56
 GREENBERG PAR ciseaux 46
 GREGORY ciseaux 43
 GROSSMAN marqueur pour l'aréole 11
 HAJEK maillet 123
 HALLE éleveur 132
 HALSEY porte-aiguilles 107
 HALSTED-MOSQUITO pinces hémostatiques 76
 HALSTED-MOSQUITO pinces hémostatiques *PRIMUSLINE* 72
 HARTMANN pinces hémostatiques 76
 HARTMANN pinces hémostatiques *PRIMUSLINE* 72
 HARTMANN-HALLE spéculums nasaux 140
 HEANEY porte-aiguilles 110
 HEGAR-BAUMGARTNER porte-aiguilles 106
 HOLTZHEIMER écarteurs autostatiques 95
 HUMBY dermatome 10
 Instruments à écorcher les tendons 150-151
 Instruments à mesurer 11
 ITERSON écarteurs trachéales 88
 JACKSON écarteurs trachéales 89
 JACOBSON porte-aiguilles micro 116
 JOSEPH ciseaux 37
 JOSEPH ciseaux *PRIMUSLINE* 20
 JOSEPH écarteur nasal 85
 JOSEPH éleveur 132
 JOSEPH scies nasales 143
 KAHN ciseaux 41
 KAYE BLEPHAROPLASTY ciseaux 47
 KAYE ciseaux 39
 KAYE RIBBON TYPE ciseaux 47
 KELLY ciseaux 26
 KELLY ciseaux *PRIMUSLINE* 20
 KELLY pinces hémostatiques 79
 KELLY pinces hémostatiques *PRIMUSLINE* 73
 KELLY-RANKIN pinces hémostatiques 79
 KELLY-RANKIN pinces hémostatiques *PRIMUSLINE* 73
 KILIAN ciseaux-burin 125
 KILIAN spéculums nasaux 142
 KILIAN-CALUS ciseaux-burin 125
 KILNER (RAGNELL) ciseaux 36
 KILNER écarteurs nasales 84, 87
 KILNER porte-aiguilles 110
 KLEINERT-KURTZ instruments à écorcher les tendons 151
 KNAPP (ROLLET) écarteur trachéal 90
 KNAPP ciseaux 32
 KNIGHT ciseaux nasal 44
 KOCHER pinces hémostatiques 80
 KOCHER pinces hémostatiques *PRIMUSLINE* 74
 KOCHER-FINO pinces hémostatiques *PRIMUSLINE* 75
 Lames de bistouris 8
 LANGE écarteur trachéal 84
 LERICHE pinces hémostatiques 79

LEXER ciseaux 26
 LEXER ciseaux *PRIMUSLINE* 18
 LICHTENBERG porte-aiguilles 113
 LOCKLIN ciseaux 33
 LOCKWOOD pince à tissu 82
 LUCAE maillets 124
 LUKENS écarteur trachéal 89
 MACCOLLUM-DINGMAN écarteur mammaire 92
 Maillets 123-124
 Mains en plomb 12
 Manches de bistouri 7
 MARQUARDT pince gouge 156
 Marqueurs pour l'aréole 11
 MARTINEZ-KILNER écarteur nasal 87
 MASING éleveur 135
 MATHIEU-OLSEN porte-aiguilles 106
 MAYO ciseaux 24
 MAYO-HEGAR porte-aiguilles 108
 MAYO-LEXER ciseaux *PRIMUSLINE* 18
 MAYO-STILLE ciseaux *PRIMUSLINE* 19
 MC DONALD rugine 137
 MC INDOE ciseaux 33
 MC INDOE pinces à dissection 53
 MEAD maillets 123
 METZENBAUM ciseaux *PRIMUSLINE* 16
 METZENBAUM-FINO ciseaux 30
 METZENBAUM-FINO ciseaux *PRIMUSLINE* 17
 METZENBAUM-NELSON ciseaux 28-29
 MEYERDING écarteurs 95
 MICRO-ADSON pinces à dissection 54-55
 Micro-ciseaux 48-50
 MICRO-MOSQUITO pinces hémostatiques 76
 MICRO-MOSQUITO pinces hémostatiques *PRIMUSLINE* 72
 Micro-pinces à dissection 63-65
 MIDDLETON-JANSEN pinces pour la cloison nasal 149
 MILIGAN écarteur autostatique 103
 MINI-FRIEDMAN pinces gougues 154
 MINI-RYDER porte-aiguilles 113
 MODELL WIEN spéculums nasaux 141
 MOSQUITO-DANDY pince hémostatique 77
 NEIVERT ciseaux-burin 131
 NEIVERT écarteur trachéal 88
 NEIVERT porte-aiguilles 110
 NEIVERT-ANDERSON ciseaux-burins 131
 NEUMANN ciseaux 33
 OBWEGESER écarteurs 100-101
 OBWEGESER rugines 136, 139
 OEHLER pinces à dissection à griffes 53
 OLSEN-HEGAR porte-aiguilles 107
 Ostéotomes pour la chirurgie maxillo-faciale 138
 Ostéotomes, ciseaux-burins pour rhinoplastique 125-131
 PARTSCH maillet 124
 PAR-TYPE ciseaux 46
 PÉAN pinces hémostatiques 78
 PÉAN pinces hémostatiques *PRIMUSLINE* 74
 PÉAN-FINO pinces hémostatiques *PRIMUSLINE* 75
 PECK-JOSEF ciseaux 27
 PIERSE micro-pinces à dissection 65
 Pinces à dissection 52-65
 Pinces à dissection - pinces à dissection à griffes 52-59

Français

Inhaltsverzeichnis Index

Tables de matières

Indice

Indice

Pincès à dissection à griffes - pincès à dissection.....	52-59	VANNAS micro-ciseaux.....	50
Pincès à dissection, atraumatiques	60-62	VASCULAR porte-aiguilles	111
Pincès à dissection, atraumatiques	60-62	VOLKMANN écarteurs.....	94
Pincès à dissection, Micro-.....	63-65	WALTER ciseaux-burins.....	129
Pincès à poser des clips.....	68	WANGENSTEEN pincès à dissection	53
Pincès à tampons et éponges	83	WATSON dermatome.....	10
Pincès coupantes à os.....	157	WATSON-CHEYNE rugine	137
Pincès gouges.....	154-156	WAUGH pincès à dissection	57
Pincès hémostatiques	71-81	WEBSTER porte-aiguilles.....	106
Pincès hémostatiques <i>PRIMUSLINE</i>	71-75	WEITLANER-LOKTITE écarteurs autostatiques	102
Pincès intestinales et de tissu.....	82	WILDER dilateurs pour le canal lacrymal	159
Pincès intestinales et de tissu <i>PRIMUSLINE</i>	71	WILLIAMS dilateurs pour le canal lacrymal	158
Pincès pour la cloison nasal	148-149	WILLIAMS pince à tissu.....	82
Pincès pour saisir les tendons.....	152-153	WULLSTEIN écarteurs autostatiques	103
Porte micro-lames - micro-lames.....	6	YANCOSKIE écarteur.....	98
Porte-aiguilles	105-122	YASARGIL micro-porte-aiguilles.....	119
Porte-aiguilles micro	115-122	ZAUFAL-JANSEN pince gouge.....	156
Porte-aiguilles micro manche ronde	117-119		
Porte-aiguilles, Titane-.....	121-122		
POTTS-SMITH pincès à dissection à griffes.....	58		
PROVIDENCE-HOSPITAL pincès hémostatiques	77		
QUINBY ciseaux.....	33		
RAGNELL-DAVIS écarteur.....	95		
RAMPLEY pincès à éponges.....	83		
Râpes nasales.....	144-146		
Râpes nasales, TC	146		
REES ciseaux	42		
REES ciseaux bulldog	42		
REYNOLDS (JAMESON) ciseaux	36		
REYNOLDS ciseaux <i>PRIMUSLINE</i>	19		
RIBBON STEVENS ciseaux.....	34		
RUBIN ciseaux-burins.....	129		
RUBIN pince pour la cloison nasal	149		
Rugines - éleveurs	136-137, 139		
RUSKIN pincès gouges.....	156		
RUSKIN-LISTON pincès coupantes à os.....	157		
RYDER porte-aiguilles	113		
SAROT porte-aiguilles	110		
SCHINK dermatome	9		
SCHWARZ spéculum nasal.....	140		
Scies nasales.....	143		
SEMKEN pincès à dissection.....	52		
SENN-MUELLER écarteurs.....	94		
SHEA ciseaux	45		
SHEEHAN ciseaux-burins pour rhinoplastique.....	130		
SILVER ciseaux-burins pour rhinoplastique	130		
Spéculums nasaux.....	140-142		
STELLBRINK pincès gouges.....	155		
STEVENS ciseaux	35		
STEVENS ciseaux <i>PRIMUSLINE</i>	21		
STRANDELL-STILLE écarteurs.....	94		
Stylets	159		
TAYLOR pincès à dissection	59		
THOMS-ALLIS pince à tissu.....	82		
THOREK ciseaux	44		
TIECK-HALLE spéculum nasal	140		
TIERSCH dermatome.....	9		
TRAVERS écarteur autostatique.....	103		
TYP JUWELIER micro-pincès à dissection	64		
ULTRA-MICRO-ADSON (BRAKA) pince à dissection	55		

Inhaltsverzeichnis
Index

Tables de matières
Indice
Indice

ADLERKREUTZ pinzas de disección 57

ADSON pinzas de disección 54, 55

ADSON pinzas hemostáticas..... 80

ADSON-BROWN pinzas de disección 54

ADSON-GRAEFE pinza de disección 54

ALLIS pinzas para tejidos 82

ALLIS pinzas para tejidos *PRIMUSLINE* 71

ALLIS-ADAIR pinza para tejidos 82

ALLIS-BABY pinza para tejidos..... 82

ALM separadores autoestáticos..... 95

Aplicadores para clips..... 68

Approximadores, clips..... 69

Approximadores, clips, Biemer 67

ASCH pinza para el tabique nasal 148

AUFRICHT limas nasales 144

AUFRICHT separadores nasales..... 86

AUFRICHT tijeras..... 40

BABCOCK pinzas para tejidos *PRIMUSLINE* 71

BABY-ADSON pinzas hemostáticas..... 81

BABY-CRILE-WOOD porta agujas 106

BABY-METZENBAUM tijeras *PRIMUSLINE* 17

BABY-MIXTER pinzas hemostáticas 81

BALLENGER-HAJEK elevadores para el tabique nasal..... 132

BARRAQUER porta agujas..... 114

BARRAQUER porta agujas micro..... 117

BARRON manche de bistouri..... 7

BELUCCI separadores autoestáticos 103

BEUSE tijeras..... 34

BEYER pinza gubia..... 156

BIEMER aproximadores, clips..... 67

BLUMENTHAL pinzas gubias 154

BOETTCHER tijera nasal 44

BÖHLER pinzas cortantes para huesos 157

BÖHLER pinzas gubias 155

BONN tijeras para blefaroplastica..... 45

BOWMAN dilatadores para el canal lacrimal 158

BRAND pinzas para saisir les tendons 152

BROPHY (SULLIVAN) tijeras 27

BROPHY pinzas de disección con dientes..... 58

BUNELL enucleador de tendones..... 150, 151

CAPLAN pinza para el tabique nasal 149

CAROLL pinza para tendones..... 153

CASTANARES tijeras para el face-lift 43

CASTROVIEJO porta agujas micro 115

CASTROVIEJO tijeras micro 50

CASTROVIEJO-JACOBSON porta agujas..... 114

CHANG marcador para aéola 11

Cinceles para la cirugía maxilofacial..... 138

Cinceles para rinoplastica..... 125-131

CINELLI cinceles..... 127

COLLIN martillo 123

Contenedores para instrumentos 161

CONVERSE separador nasal..... 86

CONVERSE tijeras 34

CORONAL LIFT separador 98

COTTLE cinceles..... 125, 126, 128

COTTLE elevadores 132-135

COTTLE espéculos nasales 141-142

COTTLE lima nasal..... 144

COTTLE prensa para huesos 160

COTTLE separadores traqueales 84, 85, 87, 88

COTTLE-KAZANJIAN pinza cortante para huesos 157

COTTLE-NEIVERT separador nasal 88

COTTLE-WALSHAM pinzas para el tabique nasal..... 148

CRILE pinzas hemostáticas 78

CRILE pinzas hemostáticas *PRIMUSLINE* 73

CRILE separadores nasales..... 85

CRILE-MURRAY porta agujas 105

CRILE-RANKIN pinzas hemostáticas..... 78

CRILE-RANKIN pinzas hemostáticas *PRIMUSLINE*..... 73

CRILE-WOOD porta agujas..... 105

CUSHING pinzas de disección 52

DANDY pinzas hemostáticas 77

DAVIS tijeras para el face-lift 42

DE BAKEY BAYONET pinzas de disección atraumaticas..... 60

DE BAKEY pinzas de disección atraumaticas 61, 62

DE Bakey porta agujas 111

DE BAKEY-GERALD pinzas de disección atraumaticas 60

DERF porta agujas..... 105

Dermatomos..... 9-10

DESMARRES separadores..... 90

DIETHRICH porta agujas 113

Dilatadores para el canal lacrimal..... 158-159

Dilatadores vasculares..... 66

DUEHRSEN pinza de disección 57

Elevadores para el tabique nasal..... 132-135

Enucleadores de tendones..... 150-151

Especulos nasales 140-142

FERREIRA separadores..... 99

FERREIRA separadores mamarias..... 92

FISCHER enucleador de tendones..... 151

FOERSTER (BALLENGER) pinzas para esponjas 83

FOMON cinceles..... 127

FOMON limas nasales 145-146

FOMON separadores nasales..... 84, 88

FOMON tijeras nasales..... 44

FOSTER-GILLIES porta agujas..... 109

FREEMAN marcadores para aéola..... 11

FREEMAN separadores..... 96-97, 99

FREEMAN-KAYE tijeras..... 40

FREER elevadores..... 133, 135

FRIEDMAN pinza gubia 154

GALLAHER limas nasales 145

GERALD pinzas de disección 59

GILLIES pinza de disección con dientes..... 53

GILLIES porta agujas 109

GILLIES separador nasal 84

GOLDMAN-FOX tijeras 41

GORNEY PLATYSMA tijeras..... 38

GORNEY separador 96

GORNEY tijeras..... 37

GORNEY-DELICATE tijeras..... 39

GORNEY-FREEMAN tijeras 38

GRADLE tijeras..... 32

GRAEFE pinzas de disección 56

GREENBERG PAR tijeras..... 46

GREGORY tijeras 43

GROSSMAN marcador para aéola..... 11

HAJEK martillo 123

HALLE elevador 132

Inhaltsverzeichnis Index

Tables de matières Indice Indice

HALSEY porta agujas	107	MARTINEZ-KILNER separador nasal.....	87
HALSTED-MOSQUITO pinzas hemostáticas	76	MASING elevador	135
HALSTED-MOSQUITO pinzas hemostáticas <i>PRIMUSLINE</i>	72	MATHIEU-OLSEN porta agujas.....	106
HARTMANN pinzas hemostáticas	76	MAYO tijeras.....	24
HARTMANN pinzas hemostáticas <i>PRIMUSLINE</i>	72	MAYO-HEGAR porta agujas.....	108
HARTMANN-HALLE espéculos nasales.....	140	MAYO-LEXER tijeras <i>PRIMUSLINE</i>	18
HEANEY porta agujas.....	110	MAYO-STILLE tijeras <i>PRIMUSLINE</i>	19
HEGAR-BAUMGARTNER porta agujas.....	106	MC DONALD raspatorio	137
Hojas de busturí	8	MC INDOE pinzas de disección	53
HOLTZHEIMER separadores autoestáticos	95	MC INDOE tijeras	33
HUMBY dermatomo.....	10	MEAD martillos.....	123
Instrumentos de medida	11	METZENBAUM tijeras <i>PRIMUSLINE</i>	16
ITERSON separadores traqueales	88	METZENBAUM-FINO tijeras	30
JACKSON separadores traqueales	89	METZENBAUM-FINO tijeras <i>PRIMUSLINE</i>	17
JACOBSON porta agujas micro	116	METZENBAUM-NELSON tijeras.....	28-29
JOSEPH elevador	132	MEYERDING separadores.....	95
JOSEPH separador nasal	85	MICRO-ADSON pinzas de disección	54-55
JOSEPH sierras nasales.....	143	MICRO-MOSQUITO pinzas hemostáticas	76
JOSEPH tijeras.....	37	MICRO-MOSQUITO pinzas hemostáticas <i>PRIMUSLINE</i>	72
JOSEPH tijeras <i>PRIMUSLINE</i>	20	Micro-pinzas de disección.....	63-65
KAHN tijeras.....	41	Micro-tijeras.....	48-50
KAYE BLEPHAROPLASTY tijeras.....	47	MIDDLETON-JANSEN pinzas para el tabique nasal	149
KAYE RIBBON TYPE tijeras	47	MILIGAN separador autoestático.....	103
KAYE tijeras.....	39	MINI-FRIEDMAN pinzas gubias	154
KELLY pinzas hemostáticas	79	MINI-RYDER porta agujas	113
KELLY pinzas hemostáticas <i>PRIMUSLINE</i>	73	MODELL WIEN espéculos nasales.....	141
KELLY tijeras.....	26	MOSQUITO-DANDY pinza hemostática.....	77
KELLY tijeras <i>PRIMUSLINE</i>	20	NEIVERT cincel	131
KELLY-RANKIN pinzas hemostáticas	79	NEIVERT porta agujas.....	110
KELLY-RANKIN pinzas hemostáticas <i>PRIMUSLINE</i>	73	NEIVERT separador traqueal.....	88
KILIAN cincel	125	NEIVERT-ANDERSON cinceles	131
KILIAN espéculos nasales	142	NEUMANN tijeras	33
KILIAN-CALUS cincel	125	OBWEGESER raspatorios.....	136, 139
KILNER (RAGNELL) tijeras.....	36	OBWEGESER separadores.....	100-101
KILNER porta agujas.....	110	OEHLER pinzas de disección con dientes	53
KILNER separadores nasales.....	84, 87	OLSEN-HEGAR porta agujas	107
KLEINERT-KURTZ enucleador de tendones.....	151	PARTSCH martillo.....	124
KNAPP (ROLLET) separador traqueal.....	90	PAR-TYPE tijeras.....	46
KNAPP tijeras	32	PÉAN pinzas hemostáticas	78
KNIGHT tijeras nasal	44	PÉAN pinzas hemostáticas <i>PRIMUSLINE</i>	74
KOCHER pinzas hemostáticas	80	PÉAN-FINO pinzas hemostáticas <i>PRIMUSLINE</i>	75
KOCHER pinzas hemostáticas <i>PRIMUSLINE</i>	74	PECK-JOSEF tijeras.....	27
KOCHER-FINO pinzas hemostáticas <i>PRIMUSLINE</i>	75	Periostótomos - elevadores.....	136-137, 139
LANGE separador traqueal.....	84	PIERSE micro-pinzas de disección	65
LERICHE pinzas hemostáticas.....	79	Pinzas cortantes para huesos	157
LEXER tijeras	26	Pinzas de disección	52-65
LEXER tijeras <i>PRIMUSLINE</i>	18	Pinzas de disección - pinzas de disección con dientes	52-59
LICHTENBERG porta agujas	113	Pinzas de disección atraumaticas	60-62
Limas nasales.....	144-146	Pinzas de disección, Micro-.....	63-65
Limas nasales, TC.....	146	Pinzas gubias.....	154-156
LOCKLIN tijeras.....	33	Pinzas hemostáticas.....	71-81
LOCKWOOD pinza para tejidos	82	Pinzas hemostáticas <i>PRIMUSLINE</i>	71-75
LUCAE martillos	124	Pinzas para el tabique nasal.....	148-149
LUKENS separador traqueal.....	89	Pinzas para tampones y esponjas	83
MACCOLLUM-DINGMAN separador mamaria	92	Pinzas para tejidos y intestinos.....	82
Mangos de bisturí.....	7	Pinzas para tejidos y intestinos <i>PRIMUSLINE</i>	71
Manos de plomo	12	Pinzas para tendones	152-153
Marcadores para aéola.....	11	Porta agujas	105-122
MARQUARDT pinza gubia.....	156	Porta agujas, Micro-.....	115-122
Martillos	123-124	Porta agujas, Micro-, mango redondo.....	117-119

**Inhaltsverzeichnis
Index**
**Tables de matières
Indice
Indice**

Porta agujas, Titanio-	121-122
Porta para micro-hojas - micro-hojas	6
POTTS-SMITH pinzas de disección con dientes	58
Prensas para huesos	160
PROVIDENCE-HOSPITAL pinzas hemostáticas	77
QUINBY tijeras	33
RAGNELL-DAVIS separador	95
RAMPLEY pinzas para esponjas	83
REES tijeras	42
REES tijeras bulldog	42
REYNOLDS (JAMESON) tijeras	36
REYNOLDS tijeras <i>PRIMUSLINE</i>	19
RIBBON STEVENS tijeras	34
RUBIN cinceles	129
RUBIN pinza para el tabique nasal	149
RUSKIN pinzas gubias	156
RUSKIN-LISTON pinzas cortantes para huesos	157
RYDER porta agujas	113
SAROT porta agujas	110
SCHINK dermatomo	9
SCHWARZ espéculo nasal	140
SEMKEN pinzas de disección	52
SENN-MUELLER separadores	94
Separadores	94-101
Separadores autoestáticos	102-103
Separadores mamarias	91-93
Separadores para la cirugía maxilofacial	100-101
Separadores traqueales	89-90
Separadores traqueales y nasales	84-88
SHEA tijeras	45
SHEEHAN cinceles para rinoplastica	130
Sierras nasales	143
SILVER cinceles para rinoplastica	130
Sondas acanaladas	159
STELLBRINK pinzas gubias	155
STEVENS tijeras	35
STEVENS tijeras <i>PRIMUSLINE</i>	21
STRANDELL-STILLE separadores	94
TAYLOR pinzas de disección	59
THOMS-ALLIS pinza para tejidos	82
THOREK tijeras	44
TIECK-HALLE espéculo nasal	140
TIERSCH dermatomo	9
Tijeras	16-51
Tijeras finas	32-34
Tijeras nasales	44
Tijeras para blefaroplastica	45-47
Tijeras para cirugía	24-27
Tijeras para cirugía - tijeras de disección	28-30
Tijeras para el face-lift	42-43
Tijeras para estrabismo	32
Tijeras para iridectomia	31
Tijeras para la cirugía plástica	36-41
Tijeras para tendones	35
Tijeras, micro-	48-51
TRAVERS separador autoestático	103
TYP JUWELIER micro-pinzas de disección	64
ULTRA-MICRO-ADSON (BRAKA) pinza de disección	55
VANNAS micro-tijeras	50
VASCULAR porta agujas	111

VOLKMANN separadores	94
WALTER cinceles	129
WANGENSTEEN pinzas de disección	53
WATSON dermatomo	10
WATSON-CHEYNE raspatorio	137
WAUGH pinzas de disección	57
WEBSTER porta agujas	106
WEITLANER-LOKTITE separadores autoestáticos	102
WILDER dilatadores para el canal lacrimal	159
WILLIAMS dilatadores para el canal lacrimal	158
WILLIAMS pinza para tejidos	82
WULLSTEIN separadores autoestáticos	103
YANCOSKIE separador	98
YASARGIL micro-porta agujas	119
ZAUFAL-JANSEN pinza gubia	156

Inhaltsverzeichnis Index

Tables de matières Indice Indice

ADLERKREUTZ pinze per dissezione	57	COTTLE-NEIVERT uncino nasale	88
ADSON pinze emostatiche	80	COTTLE-WALSHAM pinze per il setto nasale	148
ADSON pinze per dissezione	54, 55	CRILE pinze emostatiche	78
ADSON-BROWN pinze per dissezione	54	CRILE pinze emostatiche PRIMUSLINE	73
ADSON-GRAEFE pinza per dissezione	54	CRILE uncini nasali	85
ALLIS pinze per tessuti	82	CRILE-MURRAY porta aghi	105
ALLIS pinze per tessuti PRIMUSLINE	71	CRILE-RANKIN pinze emostatiche	78
ALLIS-ADAIR pinza per tessuti	82	CRILE-RANKIN pinze emostatiche PRIMUSLINE	73
ALLIS-BABY pinza per tessuti	82	CRILE-WOOD porta aghi	105
ALM divaricatori autostatici	95	CUSHING pinze per dissezione	52
Approssimatori, clips vascolari	69	DANDY pinze emostatiche	77
Approssimatori, clips vascolari, Biemer	67	DAVIS forbici per face-lift	42
ASCH pinza per il setto nasale	148	DE BAKEY BAYONET pinze per dissezione atraumatiche	60
AUFRICHT forbici	40	DE BAKEY pinze per dissezione atraumatiche	61, 62
AUFRICHT raspe nasali	144	DE Bakey porta aghi	111
AUFRICHT uncini nasali	86	DE BAKEY-GERALD pinze per dissezione atraumatiche	60
BABCOCK pinze per tessuti PRIMUSLINE	71	DERF porta aghi	105
BABY-ADSON pinze emostatiche	81	Dermatomi	9-10
BABY-CRILE-WOOD porta aghi	106	DESMARRES divaricatori	90
BABY-METZENBAUM forbici PRIMUSLINE	17	DIETHRICH porta aghi	113
BABY-MIXTER pinze emostatiche	81	Dilatatori lacrimali	158-159
BALLENGER-HAJEK elevatori per il setto nasale	132	Dilatatori vascolari	66
BARRAQUER porta aghi	114	Divaricatori	94-101
BARRAQUER porta aghi micro	117	Divaricatori autostatici	102-103
BARRON manico per bisturi	7	Divaricatori per la chirurgia massilofaciale	100-101
BELUCCI divaricatori autostatici	103	Divaricatori per seno	91-93
BEUSE forbici	34	Divaricatori tracheali	89-90
BEYER pinza sgorbia	156	Divaricatori tracheali ed nasali	84-88
BIEMER approssimatori, clips vascolari	67	DUEHRSEN pinza per dissezione	57
BLUMENTHAL pinze sgorbie	154	Elevatori per il setto nasale	132-135
BOETTCHER forbici nasale	44	FERREIRA divaricatori	99
BÖHLER cesoie per ossa	157	FERREIRA divaricatori per seno	92
BÖHLER pinze sgorbie	155	FISCHER scollatendini	151
BONN forbici per blefaroplastica	45	FOERSTER (BALLENGER) pinze per tamponi	83
BOWMAN dilatatori lacrimali	158	FOMON forbici nasali	44
BRAND pinze per afferrare tendini	152	FOMON raspe nasali	145-146
BROPHY (SULLIVAN) forbici	27	FOMON sclapelli	127
BROPHY pinze per dissezione con denti	58	FOMON uncini nasali	84, 88
BUNELL scollatendini	150, 151	Forbici	16-51
CAPLAN pinza per il setto nasale	149	Forbici fine	32-34
CAROLL pinza per tendini	153	Forbici nasali	44
CASTANARES forbici per face-lift	43	Forbici per blefaroplastica	45-47
CASTROVIEJO forbici micro	50	Forbici per chirurgia	24-27
CASTROVIEJO porta aghi micro	115	Forbici per chirurgia - forbici per dissezione	28-30
CASTROVIEJO-JACOBSON porta aghi	114	Forbici per face-lift	42-43
Cesoie per ossa	157	Forbici per iridectomia	31
CHANG marcatore per areola	11	Forbici per la chirurgia plastica	36-41
CINELLI sclapelli	127	Forbici per strabismo	32
COLLIN martello	123	Forbici per tendini	35
Contenedori per strumenti	161	Forbici, micro-	48-51
CONVERSE forbici	34	FOSTER-GILLIES porta aghi	109
CONVERSE uncino nasale	86	FREEMAN divaricatori	96-97, 99
CORONAL LIFT divaricatore	98	FREEMAN marcatori per areola	11
COTTLE divaricatori tracheali	84, 85, 87, 88	FREEMAN-KAYE forbici	40
COTTLE elevatori	132-135	FREER elevatori	133, 135
COTTLE raspa nasale	144	FRIEDMAN pinza sgorbia	154
COTTLE sclapelli	125, 126, 128	GALLAHER raspe nasali	145
COTTLE specoli nasali	141-142	GERALD pinze per dissezione	59
COTTLE trittatore osseo	160	GILLIES pinza per dissezione con denti	53
COTTLE-KAZANJIAN cesoia per ossa	157	GILLIES porta aghi	109

**Inhaltsverzeichnis
Index**
**Tables de matières
Indice
Indice**

GILLIES uncino nasale.....	84
GOLDMAN-FOX forbici.....	41
GORNEY divaricatore.....	96
GORNEY forbici.....	37
GORNEY PLATYSMA forbici.....	38
GORNEY-DELICATE forbici.....	39
GORNEY-FREEMAN forbici.....	38
GRADLE forbici.....	32
GRAEFE pinze per dissezione.....	56
GREENBERG PAR forbici.....	46
GREGORY forbici.....	43
GROSSMAN marcatore per areola.....	11
HAJEK martello.....	123
HALLE elevatore.....	132
HALSEY porta aghi.....	107
HALSTED-MOSQUITO pinze emostatiche.....	76
HALSTED-MOSQUITO pinze emostatiche PRIMUSLINE	72
HARTMANN pinze emostatiche.....	76
HARTMANN pinze emostatiche PRIMUSLINE	72
HARTMANN-HALLE specoli nasali.....	140
HEANEY porta aghi.....	110
HEGAR-BAUMGARTNER porta aghi.....	106
HOLTZHEIMER divaricatori autostatici.....	95
HUMBY dermatomo.....	10
ITERSON divaricatori tracheali.....	88
JACKSON divaricatori tracheali.....	89
JACOBSON porta aghi micro.....	116
JOSEPH elevatore.....	132
JOSEPH forbici.....	37
JOSEPH forbici PRIMUSLINE	20
JOSEPH seghe nasali.....	143
JOSEPH uncino nasale.....	85
KAHN forbici.....	41
KAYE BLEPHAROPLASTY forbici.....	47
KAYE forbici.....	39
KAYE RIBBON TYPE forbici.....	47
KELLY forbici.....	26
KELLY forbici PRIMUSLINE	20
KELLY pinze emostatiche.....	79
KELLY pinze emostatiche PRIMUSLINE	73
KELLY-RANKIN pinze emostatiche.....	79
KELLY-RANKIN pinze emostatiche PRIMUSLINE	73
KILIAN sclapello.....	125
KILIAN specoli nasali.....	142
KILIAN-CALUS sclapello.....	125
KILNER (RAGNELL) forbici.....	36
KILNER porta aghi.....	110
KILNER uncini nasali.....	84, 87
KLEINERT-KURTZ scollatendini.....	151
KNAPP (ROLLET) divaricatore tracheale.....	90
KNAPP forbici.....	32
KNIGHT forbici nasale.....	44
KOCHER pinze emostatiche.....	80
KOCHER pinze emostatiche PRIMUSLINE	74
KOCHER-FINO pinze emostatiche PRIMUSLINE	75
Lame per bisturi.....	8
LANGE divaricatore tracheale.....	84
LERICHE pinze emostatiche.....	79
LEXER forbici.....	26
LEXER forbici PRIMUSLINE	18

LICHTENBERG porta aghi.....	113
LOCKLIN forbici.....	33
LOCKWOOD pinza per tessuti.....	82
LUCAE martelli.....	124
LUKENS divaricatore tracheale.....	89
MACCOLLUM-DINGMAN divaricatore per seno.....	92
Mani di piombo.....	12
Manici per bisturi.....	7
Marcatori per areola.....	11
MARQUARDT pinza sgorbia.....	156
Martelli.....	123-124
MARTINEZ-KILNER uncino nasale.....	87
MASING elevatore.....	135
MATHIEU-OLSEN porta aghi.....	106
MAYO forbici.....	24
MAYO-HEGAR porta aghi.....	108
MAYO-LEXER forbici PRIMUSLINE	18
MAYO-STILLE forbici PRIMUSLINE	19
MC DONALD rasoio.....	137
MC INDOE forbici.....	33
MC INDOE pinze per dissezione.....	53
MEAD martelli.....	123
METZENBAUM forbici PRIMUSLINE	16
METZENBAUM-FINO forbici.....	30
METZENBAUM-FINO forbici PRIMUSLINE	17
METZENBAUM-NELSON forbici.....	28-29
MEYERDING divaricatori.....	95
MICRO-ADSON pinze per dissezione.....	54-55
Micro-forbici.....	48-50
MICRO-MOSQUITO pinze emostatiche.....	76
MICRO-MOSQUITO pinze emostatiche PRIMUSLINE	72
Micro-pinze per dissezione.....	63-65
MIDDLETON-JANSEN pinze per il setto nasale.....	149
MILIGAN divaricatore autostatico.....	103
MINI-FRIEDMAN pinze sgorbie.....	154
MINI-RYDER porta aghi.....	113
MODELL WIEN specoli nasali.....	141
MOSQUITO-DANDY pinza emostatica.....	77
NEIVERT divaricatore tracheale.....	88
NEIVERT porta aghi.....	110
NEIVERT sclapello.....	131
NEIVERT-ANDERSON sclapelli.....	131
NEUMANN forbici.....	33
OBWEGESER divaricatori.....	100-101
OBWEGESER raspiatori.....	136, 139
OEHLER pinze per dissezione con denti.....	53
OLSEN-HEGAR porta aghi.....	107
PARTSCH martello.....	124
PAR-TYPE forbici.....	46
PÉAN pinze emostatiche.....	78
PÉAN pinze emostatiche PRIMUSLINE	74
PÉAN-FINO pinze emostatiche PRIMUSLINE	75
PECK-JOSEF forbici.....	27
PIERSE micro-pinze per dissezione.....	65
Pinze emostatiche.....	71-81
Pinze emostatiche PRIMUSLINE	71-75
Pinze per dissezione.....	52-65
Pinze per dissezione - pinze per dissezione con denti.....	52-59
Pinze per dissezione atraumatiche.....	60-62
Pinze per dissezione, Micro-.....	63-65

Inhaltsverzeichnis Index

Tables de matières Indice Indice

Pinze per il setto nasale	148-149	VOLKMANN divaricatori	94
Pinze per mettere clips.....	68	WALTER scapelli	129
Pinze per tamponi.....	83	WANGENSTEEN pinze per dissezione	53
Pinze per tendini.....	152-153	WATSON dermatomo.....	10
Pinze per tessuti ed intestinali	82	WATSON-CHEYNE rasoio.....	137
Pinze per tessuti ed intestinali <i>PRIMUSLINE</i>	71	WAUGH pinze per dissezione	57
Pinze sgorbie	154-156	WEBSTER porta aghi.....	106
Porta aghi	105-122	WEITLANER-LOKTITE divaricatori autostatici.....	102
Porta aghi, Micro-.....	115-122	WILDER dilatatori lacrimali.....	159
Porta aghi, Micro-, manico rotondo	117-119	WILLIAMS dilatatori lacrimali	158
Porta aghi, Titanio-.....	121-122	WILLIAMS pinza per tessuti.....	82
Porta per micro-lame - micro-lame.....	6	WULLSTEIN divaricatori autostatici	103
POTTS-SMITH pinze per dissezione con denti	58	YANCOSKIE divaricatore	98
PROVIDENCE-HOSPITAL pinze emostatiche.....	77	YASARGIL micro-porta aghi	119
QUINBY forbici	33	ZAUFAL-JANSEN pinza sgorbia.....	156
RAGNELL-DAVIS divaricatore	95		
RAMPLEY pinze per tamponi.....	83		
Raspari - elevatori	136-137, 139		
Raspe nasali	144-146		
Raspe nasali, TC	146		
REES forbici	42		
REES forbici bulldog	42		
REYNOLDS (JAMESON) forbici	36		
REYNOLDS forbici <i>PRIMUSLINE</i>	19		
RIBBON STEVENS forbici	34		
RUBIN pinza per il setto nasale.....	149		
RUBIN scapelli.....	129		
RUSKIN pinze sgorbie.....	156		
RUSKIN-LISTON cesoie per ossa	157		
RYDER porta aghi	113		
SAROT porta aghi	110		
Scapelli per chirurgia massilofaciale.....	138		
Scapelli per plastica nasale.....	125-131		
SCHINK dermatomo	9		
SCHWARZ specolo nasale.....	140		
Scollatendini.....	150-151		
Seghe nasali	143		
SEMKEN pinze per dissezione.....	52		
SENN-MUELLER divaricatori	94		
SHEA forbici	45		
SHEEHAN scapelli per plastica nasale	130		
SILVER scapelli per plastica nasale.....	130		
Sonde scanalate	159		
Specoli nasali	140-142		
STELLBRINK pinze sgorbie	155		
STEVENS forbici	35		
STEVENS forbici <i>PRIMUSLINE</i>	21		
STRANDELL-STILLE divaricatori	94		
Strumenti per la misurazione	11		
TAYLOR pinze per dissezione.....	59		
THOMS-ALLIS pinza per tessuti	82		
THOREK forbici.....	44		
TIECK-HALLE specolo nasale	140		
TIERSCH dermatomo.....	9		
TRAVERS divaricatore autostatico	103		
Trittori osseo	160		
TYP JUWELIER micro-pinze per dissezione	64		
ULTRA-MICRO-ADSON (BRAKA) pinza per dissezione	55		
VANNAS micro-forbici.....	50		
VASCULAR porta aghi	111		

Wichtige Hinweise

Dieser Katalog bleibt Eigentum der Firma TEKNO-MEDICAL Optik-Chirurgie GmbH, auch wenn dafür eine Schutzgebühr bezahlt wurde. Er kann von uns jederzeit zurückgefordert werden, wenn er gegen unsere Interessen und nicht zum Vertrieb und Einkauf von TEKNO Produkten verwendet wird. Auch behalten wir uns in solch einem Falle weitergehende Maßnahmen vor.

Der Nachdruck oder Kopieren dieses Kataloges – im Gesamten oder auch nur auszugsweise – ist ohne unsere schriftliche Genehmigung verboten.

Modelländerungen vorbehalten. Gedruckt in der Bundesrepublik Deutschland

Important notice

This catalogue remains property of TEKNO-MEDICAL Optik-Chirurgie GmbH even if we have asked for a lending fee of charges. We can at any time recall the catalogue, in case that it has been not used according to our interests, i.e. sale or purchase of TEKNO products. We preserve the right for further steps in that case.

Reproduction or copying of this catalogue in whole or in parts is forbidden without our written permission.

Patterns are subject to change. Printed in Germany

Indications importantes

Ce catalogue reste la propriété de TEKNO-MEDICAL Optik-Chirurgie GmbH, même si nous avons demandé le paiement d'une taxe de protection. Nous pouvons demander le retour du catalogue dans le cas où celui-ci n'est pas utilisé conformément à nos intérêts, pour la vente ou l'achat de nos produits. Dans ce cas nous nous réservons le droits de mener des actions juridiques.

La reproduction ou la copie totale ou partielle de ce catalogue est interdite sans notre accord écrit.

Sous réserve des modifications techniques. Imprimé en Allemagne

Avisos importantes

Este catálogo es propiedad de TEKNO-MEDICAL Optik-Chirurgie GmbH, aún en el caso de haber abonado por él una tasa de colaboración. Podemos solicitar la devolución del catálogo en caso de que no sea utilizado para la compra o venta de nuestros productos. En este caso nos reservamos el derecho de tomar medidas jurídicas.

La reproducción o copia total o parcial de este catálogo esta prohibido sin nuestro consentimiento escrito.

Salvo modificaciones técnicas. Impreso en la República Federal de Alemania

Avvertenze importanti

Questo catalogo rimane proprietà della TEKNO-MEDICAL Optik-Chirurgie GmbH, anche se è stato rilasciato gratuitamente o contro pagamento. Possiamo in ogni momento richiederlo indietro, in caso non stato usato in accordo con i nostri interessi (acquisto e vendita dei prodotti TEKNO-Medical). Ci riserviamo in questo caso il diritto di prendere ulteriori provvedimenti.

La copia o la riproduzione di questo catalogo in parte o nella sua totalità è vietata senza il nostro permesso scritto.

Ci riserviamo la facoltà di cambiamenti nei modelli. Stampato in Germania



TEKNO-MEDICAL Optik-Chirurgie GmbH

Sattlerstrasse 11 · 78532 Tuttlingen, Germany

Telefon +49 (74 61) 1701-0 · Fax +49 (74 61) 1701-50

mail@tekno-medical.com · www.tekno-medical.com

© 01.2010 - TEKNO-MEDICAL Optik-Chirurgie GmbH

TEKNO is a registered trademark of TEKNO-MEDICAL Optik-Chirurgie GmbH